

The background of the cover is a deep blue color with a subtle, blurred pattern of various surgical instruments, including forceps, scalpels, and probes, scattered across the surface. The instruments are rendered in a lighter shade of blue, creating a sense of depth and focus on the medical theme.

**SDI GROUP**  
Quality

**SURGICAL INSTRUMENTS  
CATALOGUE**

**FOURTH EDITION**



SDI Group was founded in 1956 by Abdul Aziz Mirza in Sialkot PAKISTAN. It's aim was to supply the major all European and world wide Trade Houses with high quality surgical instruments.

The Present General Director, Qadeer Ahmed, Joined the company in 2000 and trained in all aspects of the business. On the death of his grand father and father, in 2005 and 2007. He took control of the business and was joined by His Wife, shahzada Anwar, who is currently chairman.

Their sons, Qadeer Ahmed and Saeed Ahmed joined the company in 2000. they trained as an instrument maker for five years before moving into the office to train in all the other aspects of the busienss. They are currently the General Director and Export Directors responsible for running the ISO 9000 Quality System and the information Technology side of the Business.

The company has steadily expanded over the years and in 1980 it became necessary to move to larger premises. A Purpose built factory of 2500 sq meters.

The company realises the quality and performance are paramount and have a policy of continuous development. SDi group were one of the fourth PAKISTANI surgical instruments manufacturer to gain accreditation to BS 5750 (Now BS EN ISO 9001:2003) in August 1993. CE marking is being applied to surgical isnruments in accordance with the medical Devices Directive

Our surgical instruments are manufactued at our Sialkot factory using a combination of the lattest CNC controlled machines along with manual skills of our experienced craftsmen. This approach enables us to make surgical isnruments in the most efficient way possible whilst still retaining that finishing touch required for truly excellent instruments.

April 2009





## Introduction

Welcome to the fourth edition of the SDI Group Surgical instruments catalogue

With this catalogue we aim to provide a reference guide to the range of surgical instruments that we produce.

---

## Presentation

This Catalogue is presented in three sections.

### Section 1 Illustrated Catalogue

This is arranged by surgical procedure and then alphabetically by instrument type and instrument name.

<b>Procedure</b>	<b>Page No</b>
General	1
Plastic and Maxillo Facial	78
Ear, Nose and Throat	110
Thoracic	170
Orthopaedic	196
Gynaecology and Obstetrics	222
Neurology	236
Proctology	257
Urology	266
Ophthalmic	279
Operating Table Accessories	282

### Section 2 Index - Alphabetical

This is arranged by description of both instrument type and instrument name.

### Section 3 Index - Numerical

This is arranged by product code.

---

## LIFETIME Guarantee

SDI Group surgical instruments are guaranteed for life.

any item which is found to be defective, because of materials or poor craftsmanship, will be repaired or replaced at our discretion free of charge.

This guarantee will not cover product which have become defective through misuse, neglect, or poor quality repair by other companies.

---

# English Gauge / French Gauge / Standard Wire Gauge Conversions

English Gauge	French Gauge	Decimal Inches	Millimeters
	1	0.013	0.330
00		0.020	0.500
	2	0.026	0.660
0	3	0.039	1.000
	4	0.052	1.330
1		0.059	1.500
	5	0.065	1.660
2	6	0.079	2.000
	7	0.092	2.330
3		0.098	2.500
	8	0.105	2.660
4	9	0.118	3.000
	10	0.131	3.330
5		0.138	3.500
	11	0.144	3.660
6	12	0.157	4.000
	13	0.170	4.330
7		0.177	4.500
	14	0.183	4.660
8	15	0.196	5.000
	16	0.209	5.330
9		0.217	5.500
	17	0.223	5.660
10	18	0.236	6.000
	19	0.248	6.330
11		0.256	6.500
	20	0.262	6.660
12	21	0.276	7.000
	22	0.289	7.330
13		0.295	7.500
	23	0.302	7.660
14	24	0.316	8.000
	25	0.328	8.330
15		0.334	8.500
	26	0.340	8.660
16	27	0.354	9.000
	28	0.367	9.330
17		0.374	9.500
	29	0.380	9.660
18	30	0.394	10.000
	31	0.406	10.330
19		0.413	10.500
	32	0.419	10.660
20	33	0.434	11.000
	34	0.446	11.330
21		0.453	11.500
	35	0.459	11.660
22	36	0.472	12.000
	37	0.485	12.330
23		0.492	12.500
	38	0.498	12.660

Std Wire Gauge	Decimal Inches	Millimeters
0	0.3240	8.2294
1	0.3000	7.6199
2	0.2760	7.0103
3	0.2520	6.4007
4	0.2320	5.8927
5	0.2120	5.3847
6	0.1920	4.8767
7	0.1760	4.4703
8	0.1600	4.0639
9	0.1440	3.6575
10	0.1280	3.2511
11	0.1160	2.9463
12	0.1040	2.6415
13	0.0920	2.3368
14	0.0800	2.0320
15	0.0720	1.8288
16	0.0640	1.6256
17	0.0560	1.4224
18	0.0480	1.2192
19	0.0400	1.0160
20	0.0360	0.9144
21	0.0320	0.8128
22	0.0280	0.7112
23	0.0240	0.6096
24	0.0220	0.5588
25	0.0200	0.5080
26	0.0180	0.4572
27	0.0164	0.4166
28	0.0148	0.3759
29	0.0136	0.3454
30	0.0124	0.3150
31	0.0116	0.2946
32	0.0108	0.2743
33	0.0100	0.2540
34	0.0092	0.2337
35	0.0084	0.2134
36	0.0076	0.1930
37	0.0068	0.1727
38	0.0060	0.1524
39	0.0052	0.1321
40	0.0048	0.1219
41	0.0044	0.1118
42	0.0040	0.1016

## Metric / Imperial Conversions

Fractional Inches	Decimal Inches	Millimeters
1/64	0.016	0.397
1/32	0.031	0.794
3/64	0.047	1.191
1/16	0.063	1.587
5/64	0.078	1.984
3/32	0.094	2.381
7/64	0.109	2.778
1/8	0.125	3.175
9/64	0.141	3.572
5/32	0.156	3.969
11/64	0.172	4.366
3/16	0.188	4.762
13/64	0.203	5.159
7/32	0.219	5.556
15/64	0.234	5.953
1/4	0.250	6.350
17/64	0.266	6.747
9/32	0.281	7.144
19/64	0.297	7.540
5/16	0.313	7.937
21/64	0.328	8.334
11/32	0.344	8.731
23/64	0.359	9.128
3/8	0.375	9.525
25/64	0.391	9.922
13/32	0.406	10.319
27/64	0.422	10.715
7/16	0.438	11.112
29/64	0.453	11.509
15/32	0.469	11.906
31/64	0.484	12.303
1/2	0.500	12.700
33/64	0.516	13.097
17/32	0.531	13.493
35/64	0.547	13.890
9/16	0.563	14.287
37/64	0.578	14.684
19/32	0.594	15.081
39/64	0.609	15.478
5/8	0.625	15.875
41/64	0.641	16.272
21/32	0.656	16.668
43/64	0.672	17.065
11/16	0.688	17.462
45/64	0.703	17.859
23/32	0.719	18.256
47/64	0.734	18.653
3/4	0.750	19.050
49/64	0.766	19.446
25/32	0.781	19.843
51/64	0.797	20.240
13/16	0.813	20.637
53/64	0.828	21.034
27/32	0.844	21.431
55/64	0.859	21.828
7/8	0.875	22.225
57/64	0.891	22.621
29/32	0.906	23.018
59/64	0.922	23.415
15/16	0.938	23.812
61/64	0.953	24.209
31/32	0.969	24.606
63/64	0.984	25.003
1	1.000	25.400

Fractional Inches	Decimal Inches	Millimeters
1	1.000	25.4
1 1/8	1.125	28.6
1 1/4	1.250	31.7
1 3/8	1.375	34.9
1 1/2	1.500	38.1
1 5/8	1.625	41.3
1 3/4	1.750	44.4
1 7/8	1.875	47.6
2	2.000	50.8
2 1/8	2.125	54.0
2 1/4	2.250	57.1
2 3/8	2.375	60.3
2 1/2	2.500	63.5
2 5/8	2.625	66.7
2 3/4	2.750	69.8
2 7/8	2.875	73.0
3	3.000	76.2
3 1/8	3.125	79.4
3 1/4	3.250	82.5
3 3/8	3.375	85.7
3 1/2	3.500	88.9
3 5/8	3.625	92.1
3 3/4	3.750	95.2
3 7/8	3.875	98.4
4	4.000	102
4 1/4	4.000	102
4 1/2	4.250	108
4 3/4	4.500	114
5	5.000	127
5 1/4	5.250	133
5 1/2	5.500	140
5 3/4	5.750	146
6	6.000	152
6 1/4	6.250	159
6 1/2	6.500	165
6 3/4	6.750	171
7	7.000	178
7 1/4	7.250	184
7 1/2	7.500	190
7 3/4	7.750	197
8	8.000	203
8 1/4	8.250	210
8 1/2	8.500	216
8 3/4	8.750	222
9	9.000	229
9 1/4	9.250	235
9 1/2	9.500	241
9 3/4	9.750	248
10	10.000	254
10 1/4	10.250	260
10 1/2	10.500	267
10 3/4	10.750	273
11	11.000	279
11 1/4	11.250	286
11 1/2	11.500	292
11 3/4	11.750	298
12	12.000	305
12 1/4	12.250	311
12 1/2	12.500	317
12 3/4	12.750	324
13	13.000	330
13 1/4	13.250	337
13 1/2	13.500	343
13 3/4	13.750	349

# Instructions For Re-Processing Of Reuseable Devices

---

The following instructions are for all reuseable medical devices supplied by SDI unless stated otherwise with the packaging of the product. These instructions are intended for use only by persons with the required specialist knowledge and training.

## WARNINGS

- Follow instructions and warnings as issued by manufacturers of any decontaminants, disinfectants and cleaning agents used. Wherever possible avoid use of mineral acids and harsh, abrasive agents.
- No part of the process shall exceed 140°C.
- Aluminium and Lead based devices are damaged by high alkaline solutions (pH > 10).
- Rubber, Plastic, Blackened, Insulated and Fibrelight devices are damaged by high alkaline solutions (pH > 10).
- Devices with long, narrow cannula, hinges and blind holes require particular attention during cleaning.

**Note:** when reprocessing medical devices, always handle with care, wearing protective clothing, gloves and eyewear in accordance with local Health & Safety procedures.

## Limitations On Reprocessing

- Repeated processing has minimal effect on these devices.
- End of life is normally determined by wear and damage in use.
- Any specific limitations on the number of reprocessing cycles shall be made available with the device.

## INSTRUCTIONS

### From Point Of Use

- Wherever possible, do not allow blood, debris or bodily fluids to dry on devices. For best results, and to prolong the life of the device, reprocess immediately after use. If they cannot be reprocessed immediately, use an enzymatic foam spray cleaner to help prevent soil from drying.

### Preparation For Decontamination

- Reprocess all devices as soon as it is reasonably practical following use.
- Disassemble only where intended, without the use of tools unless specifically provided by the manufacturer. Where instructions for disassembly are required, these are available with the device.

## Cleaning - Automated

- **Use only either CE marked or validated washer-disinfector machines and low-foaming, non-ionising cleaning agents and detergents following the manufacturers instructions for use, warnings, concentrations and recommended cycles.**
- Load devices carefully, with any box joints and hinges open and so that any fenestrations in devices can drain.
- Place heavy devices with care in the bottom of containers, taking care not to overload wash baskets.
- Place devices with concave surfaces (e.g. curettes) facing down to prevent pooling of water.
- Where available, use appropriate attachments to flush inside reamers and devices with lumens or cannula.
- Ensure that soft, high purity water which is controlled for bacterial endotoxins is used in the final rinse stage.

**Note:** automated cleaning may not be suitable for all lumens and cannula, in which case clean manually with a water jet gun, if available, and an appropriate brush (and stilette if provided) that reaches the depth of the feature. After manually cleaning, pass all devices through an automated cleaning cycle to achieve disinfection.

**Note:** these instructions have been validated using a washer-disinfector cycle validated to include two cold rinses at <35°C, a detergent cycle and a rinse cycle both at >50°C, a disinfection cycle operating at a temperature of between 80°C and 87°C for a minimum holding time of 1 minute (actual holding time in excess of 2 minutes 50 seconds) and a 20 minute drying cycle. The detergent used was a low-foaming, non-ionising spray wash detergent cleaner (max 12pH) and the rinse aid a neutral pH low-foaming, non-ionic surfactant with isopropyl alcohol.

# Instructions For Re-Processing Of Reuseable Devices

---

## Cleaning - Manual

- **Manual cleaning is not advised if an automatic washer-disinfector is available. If this equipment is not available, use the following process:**
1. Use a double sink system (wash / rinse) dedicated for device cleaning (not used for hand washing). Ensure that the water temperature does not exceed 35°C.
  2. In the first sink, keeping the device submerged, with an autoclavable brush, apply CE marked cleaning solution to all surfaces until all soil has been removed. Pay particular attention to serrations, teeth, ratchets and hinges, always brushing away from the body and avoiding splashing. Ensure rongeurs and hinged devices are thoroughly cleaned in both open and closed positions.
  3. In the second sink, rinse the device thoroughly with soft, high purity water which is controlled for bacterial endotoxins, so that the water reaches all parts of the device, then carefully hand dry or use a drying cabinet.

**Note:** *manual cleaning is NOT a disinfection process. When manual cleaning is used it may not be possible to disinfect the device prior to further handling.*

## Cleaning - Inspection

- After cleaning, visually inspect all surfaces, cannulations, ratchets, joints, holes and lumens for complete removal of soil and fluids. If ANY soil or fluid is still visible, return the device for repeat decontamination.

## Maintenance

- Apply surgical grade lubricants to hinges, joints and moving parts as per the lubricant manufacturers instructions.

## Inspection And Function Testing

- Visually inspect and check:
  - all devices for damage and wear.
  - cutting edges are free of nicks and present a continuous edge.
  - jaws and teeth align correctly.
  - all articulated instruments have a smooth movement without excess play.
  - locking mechanisms (such as ratchets) fasten securely and close easily.
  - long, slender instruments are not distorted.
  - any component parts fit and assemble correctly with mating components.
- Remove for repair or replacement any blunt, worn out, flaking, fractured or damaged devices.

**Note:** *if a device is returned to the manufacturer / supplier, the device MUST be decontaminated and sterilised and be accompanied by the relevant documented evidence.*

## Packaging

- All instruments are to be packed following local protocol in accordance with BS standards.

## Sterilisation

- **Either CE marked or validated vacuum autoclave operating at 134-137°C / 2.25 bar for a minimum holding time of 3 minutes - always following the instructions of the machine manufacturer.**
- When sterilising multiple devices in one autoclave cycle, ensure that the steriliser manufacturers stated maximum load is not exceeded.
- Ensure devices are dry before sterilisation.

## Storage

- Ensure devices are dry before storage, and stored in dry, clean conditions at an ambient room temperature.

## Additional Information

- Other forms of cleaning (i.e. ultrasonic) and sterilisation (i.e. low temperature steam and formaldehyde, ethyleneoxide and gas plasma) are available. However, always follow the instructions for use as issued by the manufacturer and always consult with them if in any doubt over the suitability of any process used.
- Cleaning and sterilising guidelines are available in HTM 2030 and HTM 2010. Contact: The Stationary Office for details at [www.tso.co.uk](http://www.tso.co.uk). For further information contact: NHS Estates Information Centre, Department Of Health, 1 Trevelyan Square, Boar Lane, Leeds, LS1 6AE, UK or visit [www.nhsestates.gov.uk](http://www.nhsestates.gov.uk)

**Note:** *It is the responsibility of the reprocessor to ensure that the reprocessing as actually performed using equipment, materials and personnel in the reprocessing facility achieve the desired result. This requires validation and routine monitoring of the process. Likewise any deviation by the reprocessor from the instructions provided must be properly evaluated for effectiveness and potential adverse consequences.*



Artery Forceps

- 11000-18 Adson (Fraser) Artery Forcep, curved, 1/2 teeth, 180mm
- 11010-18 Adson (Fraser) Artery Forcep, curved, 180mm
- 11020-18 Adson (Fraser) Artery Forcep, straight, 1/2 teeth, 180mm
- 11030-18 Adson (Fraser) Artery Forcep, straight, 180mm

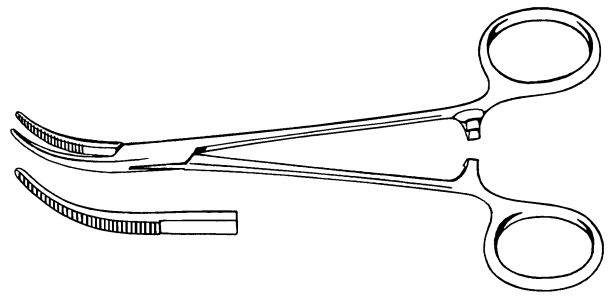

- 11040-35 Dieffenbach Artery Forcep, curved, 35mm
- 11040-50 Dieffenbach Artery Forcep, curved, 50mm
- 11050-35 Dieffenbach Artery Forcep, straight, 35mm
- 11050-50 Dieffenbach Artery Forcep, straight, 50mm

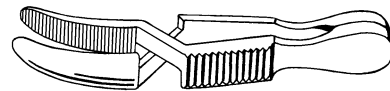

- 11060-12 Dunhill Artery Forcep, curved, box joint, 125mm
- 11060-18 Dunhill Artery Forcep, curved, box joint, 180mm
- 11070-12 Dunhill Artery Forcep, straight, box joint, 125mm

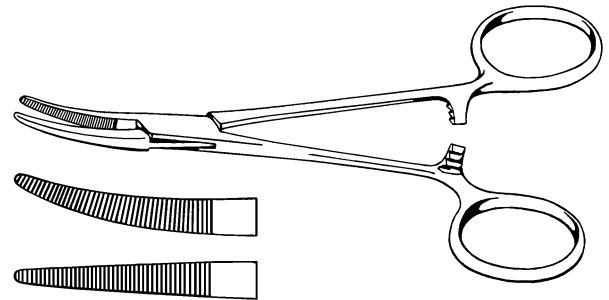

- 11080-18 Fraser Kelly Artery Forcep, curved, 180mm

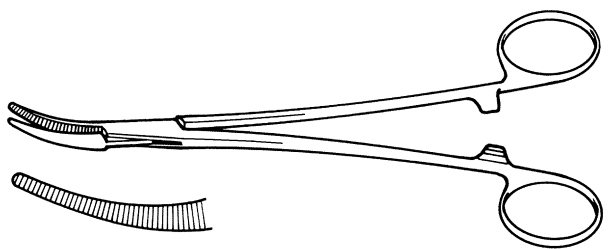

- 11090-14 Grey Turner Artery Forcep, curved, 145mm
- 11090-18 Grey Turner Artery Forcep, curved, 180mm

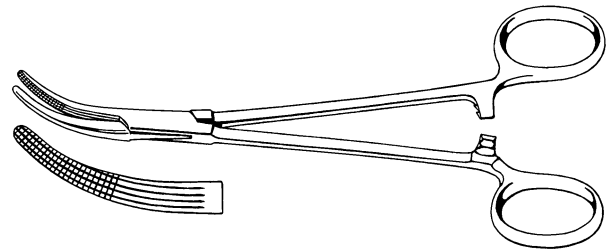

# General

## Artery Forceps

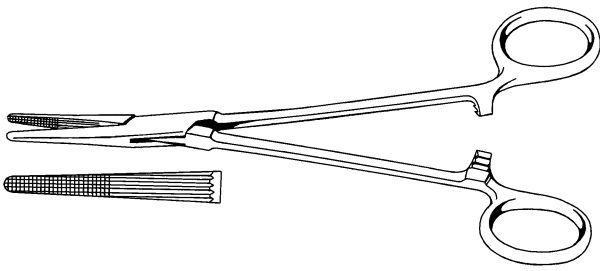

- 11100-14 Grey Turner Artery Forcep, straight, 145mm
- 11100-18 Grey Turner Artery Forcep, straight, 180mm

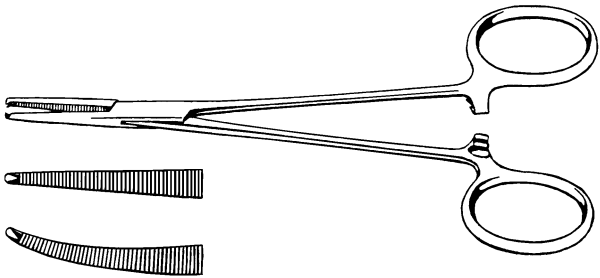

- 11110-12 Halstead Mosquito Artery Forcep, curved, 1/2 teeth, 125mm
- 11130-12 Halstead Mosquito Artery Forcep, straight, 1/2 teeth, 125mm

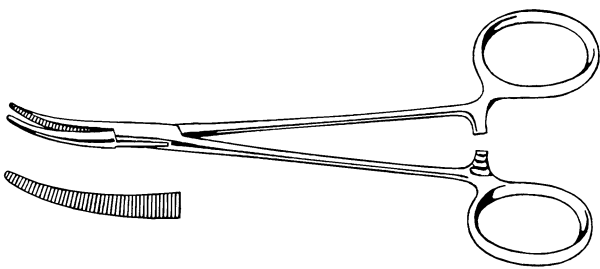

- 11120-09 Halstead Mosquito Artery Forcep, curved, serrated jaws, 95mm
- 11120-12 Halstead Mosquito Artery Forcep, curved, serrated jaws, 125mm
- 11140-09 Halstead Mosquito Artery Forcep, straight, serrated jaws, 95mm
- 11140-12 Halstead Mosquito Artery Forcep, straight, serrated jaws, 125mm

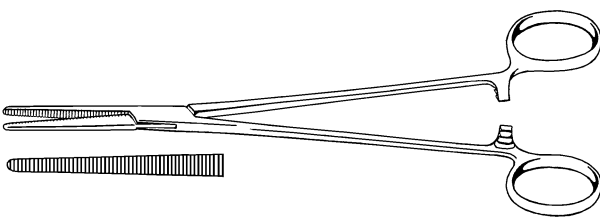

- 11150-20 Heiss Artery Forcep, curved, 200mm
- 11160-20 Heiss Artery Forcep, slightly curved, 200mm
- 11170-20 Heiss Artery Forcep, straight, 200mm

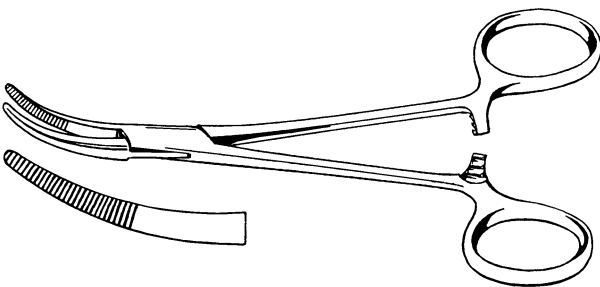

- 11180-14 Kelly-Crile Artery Forcep, curved, half serrated jaws, 145mm
- 11180-16 Kelly-Crile Artery Forcep, curved, half serrated jaws, 160mm
- 11190-14 Kelly-Crile Artery Forcep, straight, half serrated jaws, 145mm
- 11190-16 Kelly-Crile Artery Forcep, straight, half serrated jaws, 160mm



Artery Forceps

- 11200-14 Kilner Artery Forcep, curved, serrated jaws, 140mm
- 11210-14 Kilner Artery Forcep, straight, serrated jaws, 140mm

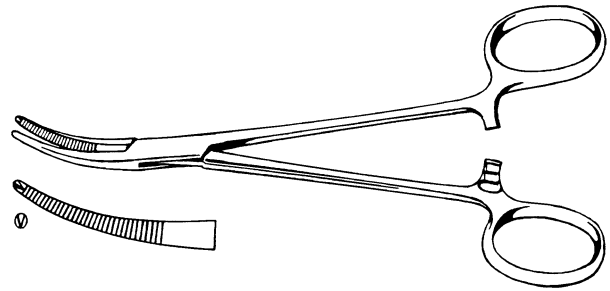

- 11220-12 Kocher Artery Forcep, curved, 1/2 teeth, 125mm
- 11220-14 Kocher Artery Forcep, curved, 1/2 teeth, 140mm
- 11220-15 Kocher Artery Forcep, curved, 1/2 teeth, 150mm
- 11220-18 Kocher Artery Forcep, curved, 1/2 teeth, 180mm
- 11220-20 Kocher Artery Forcep, curved, 1/2 teeth, 200mm
- 11220-23 Kocher Artery Forcep, curved, 1/2 teeth, 230mm

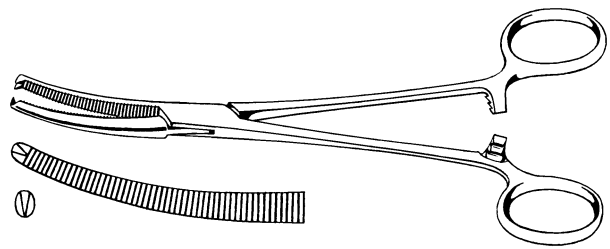

- 11230-12 Kocher Artery Forcep, straight, 1/2 teeth, 125mm
- 11230-14 Kocher Artery Forcep, straight, 1/2 teeth, 140mm
- 11230-15 Kocher Artery Forcep, straight, 1/2 teeth, 150mm
- 11230-18 Kocher Artery Forcep, straight, 1/2 teeth, 180mm
- 11230-20 Kocher Artery Forcep, straight, 1/2 teeth, 200mm
- 11230-23 Kocher Artery Forcep, straight, 1/2 teeth, 230mm

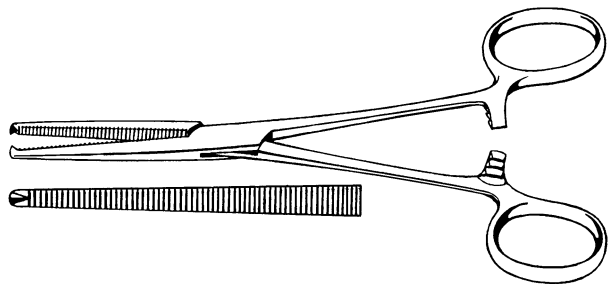

- 11240-18 Mayo Oschner Artery Forcep, curved, 185mm
- 11250-18 Mayo Oschner Artery Forcep, straight, 185mm

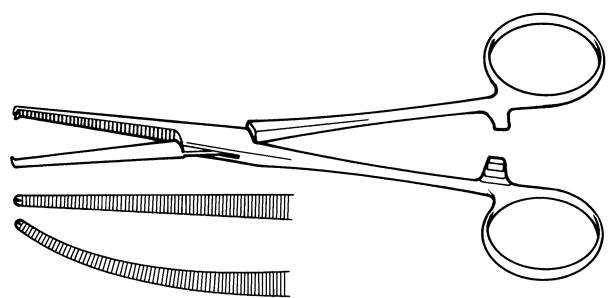

- 11260-15 Mayo Artery Forcep, curved, 150mm

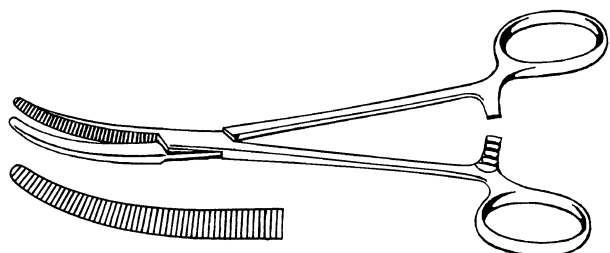

# General

## Artery Forceps

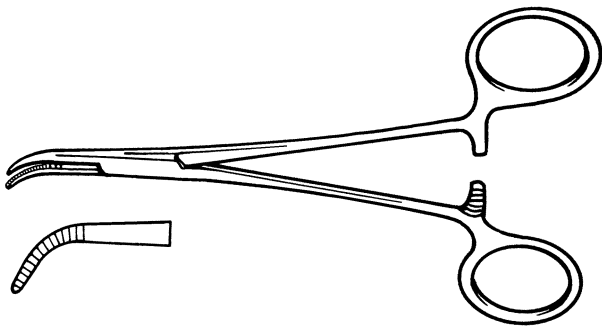

- 11270-14 Mixer Baby Artery Forcep, curved, half serrated jaws, 140mm
- 11270-18 Mixer Baby Artery Forcep, curved, half serrated jaws, 180mm

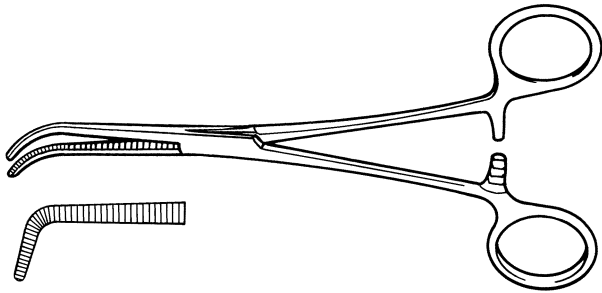

- 11275-15 Mixer Artery Forcep, curved, serrated jaws, 150mm
- 11275-18 Mixer Artery Forcep, curved, serrated jaws, 180mm

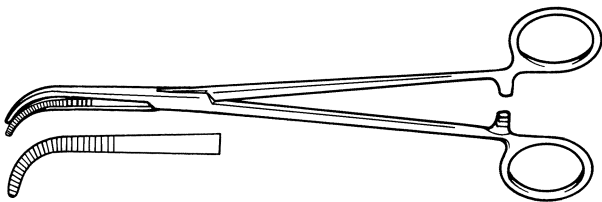

- 11275-22 Mixer Artery Forcep, curved, half serrated jaws, 220mm

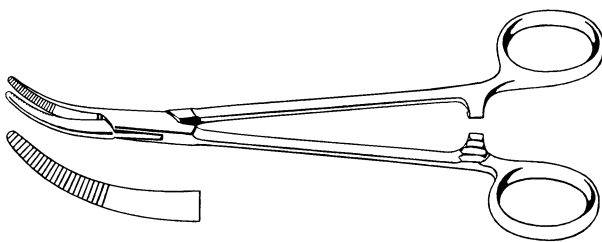

- 11280-14 Moynihan Artery Forcep, curved, half serrated jaws, 145mm
- 11280-18 Moynihan Artery Forcep, curved, half serrated jaws, 180mm

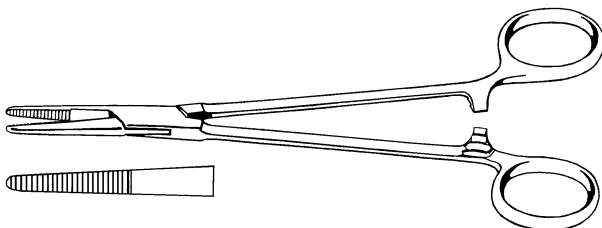

- 11290-14 Moynihan Artery Forcep, straight, half serrated jaws, 145mm
- 11290-18 Moynihan Artery Forcep, straight, half serrated jaws, 180mm

Artery Forceps

- 11300-15 O'Shaughnessy Artery Forcep, curved, 150mm
- 11300-18 O'Shaughnessy Artery Forcep, curved, 180mm
- 11300-20 O'Shaughnessy Artery Forcep, curved, 200mm

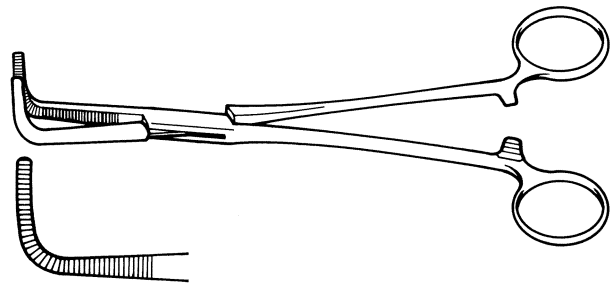

- 11310-14 Oschner Artery Forcep, curved, 1/2 teeth, 140mm
- 11310-16 Oschner Artery Forcep, curved, 1/2 teeth, 165mm
- 11310-18 Oschner Artery Forcep, curved, 1/2 teeth, 180mm
- 11310-20 Oschner Artery Forcep, curved, 1/2 teeth, 200mm
- 11310-22 Oschner Artery Forcep, curved, 1/2 teeth, 220mm
- 11310-24 Oschner Artery Forcep, curved, 1/2 teeth, 240mm

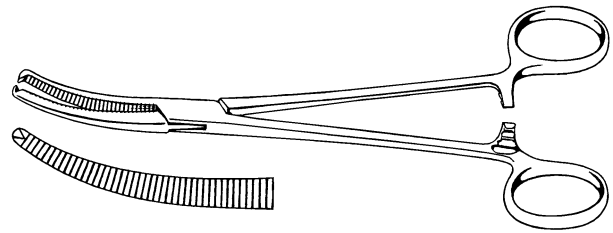

- 11320-14 Oschner Artery Forcep, straight, 1/2 teeth, 140mm
- 11320-16 Oschner Artery Forcep, straight, 1/2 teeth, 165mm
- 11320-18 Oschner Artery Forcep, straight, 1/2 teeth, 180mm
- 11320-20 Oschner Artery Forcep, straight, 1/2 teeth, 200mm
- 11320-22 Oschner Artery Forcep, straight, 1/2 teeth, 220mm
- 11320-24 Oschner Artery Forcep, straight, 1/2 teeth, 240mm

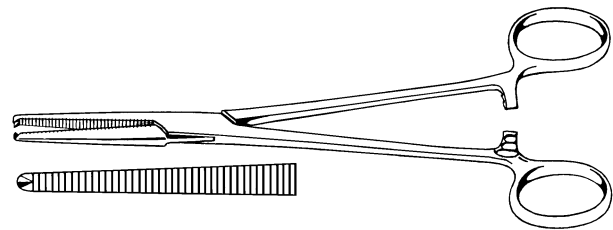

- 11330-14 Rochester-Pean Artery Forcep, curved, 140mm
- 11330-16 Rochester-Pean Artery Forcep, curved, 160mm
- 11330-18 Rochester-Pean Artery Forcep, curved, 180mm
- 11330-20 Rochester-Pean Artery Forcep, curved, 200mm
- 11330-22 Rochester-Pean Artery Forcep, curved, 220mm
- 11330-24 Rochester-Pean Artery Forcep, curved, 240mm
- 11330-26 Rochester-Pean Artery Forcep, curved, 260mm
- 11340-14 Rochester-Pean Artery Forcep, straight, 140mm
- 11340-16 Rochester-Pean Artery Forcep, straight, 160mm
- 11340-18 Rochester-Pean Artery Forcep, straight, 180mm
- 11340-20 Rochester-Pean Artery Forcep, straight, 200mm
- 11340-22 Rochester-Pean Artery Forcep, straight, 220mm
- 11340-24 Rochester-Pean Artery Forcep, straight, 240mm
- 11340-26 Rochester-Pean Artery Forcep, straight, 260mm

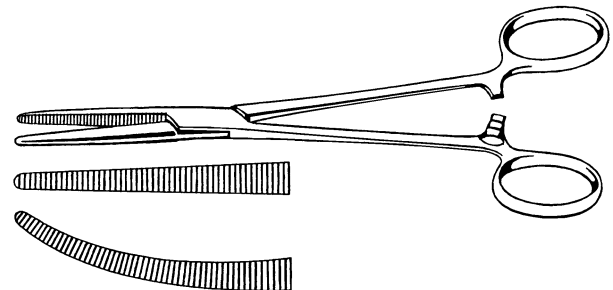

# General

## Artery Forceps

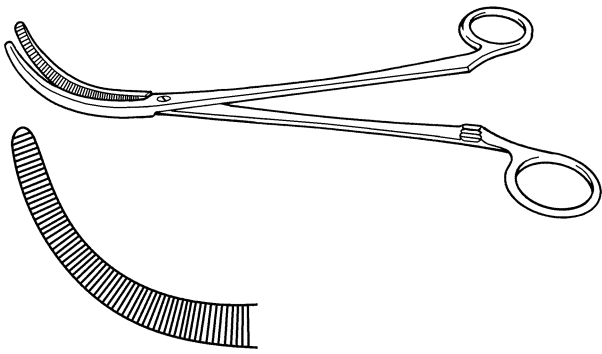

**11345-10** Ronald Edwards Artery Forcep, curved, screw joint, shape A, 215mm

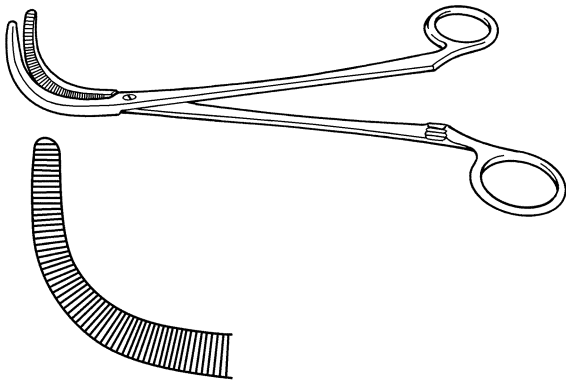

**11345-20** Ronald Edwards Artery Forcep, curved, screw joint, shape B, 215mm

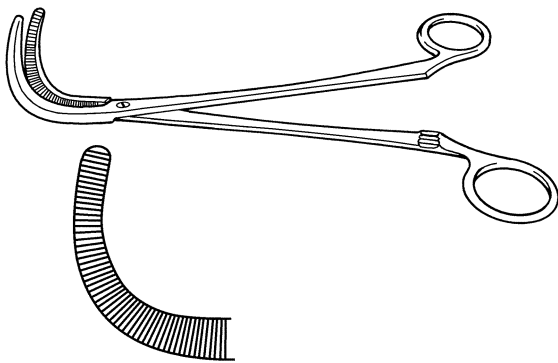

**11345-30** Ronald Edwards Artery Forcep, curved, screw joint, shape C, 215mm

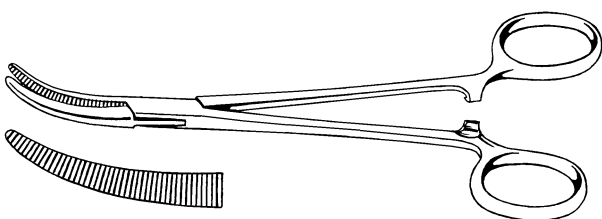

- 11350-12** Spencer-Wells Artery Forcep, curved, serrated jaws, 125mm
- 11350-15** Spencer-Wells Artery Forcep, curved, serrated jaws, 150mm
- 11350-18** Spencer-Wells Artery Forcep, curved, serrated jaws, 180mm
- 11350-20** Spencer-Wells Artery Forcep, curved, serrated jaws, 200mm
- 11350-23** Spencer-Wells Artery Forcep, curved, serrated jaws, 230mm

**Artery Forceps**

- 11360-12 Spencer-Wells Artery Forcep, straight, serrated jaws, 125mm
- 11360-15 Spencer-Wells Artery Forcep, straight, serrated jaws, 150mm
- 11360-18 Spencer-Wells Artery Forcep, straight, serrated jaws, 180mm
- 11360-20 Spencer-Wells Artery Forcep, straight, serrated jaws, 200mm
- 11360-23 Spencer-Wells Artery Forcep, straight, serrated jaws, 230mm

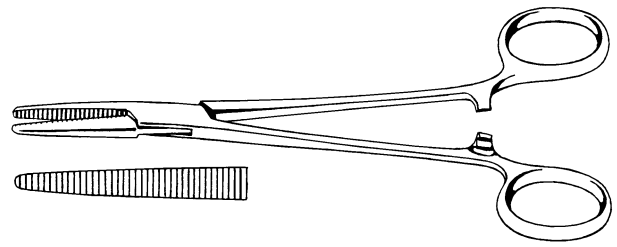

**Brushes**

- 11800-28 Wire Brush, for cleaning instruments, 280mm



**Cholecystectomy Forceps**

- 11900-23 Geary-Grant Cholecystectomy Forcep, large, non-toothed, longitudinal serrations, 230mm
- 11910-23 Geary-Grant Cholecystectomy Forcep, small, non-toothed, longitudinal serrations, 230mm

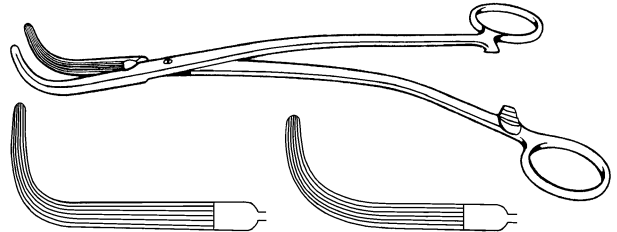

- 11920-19 Lahey Cholecystectomy Forcep, curved, longitudinal serrations, 195mm
- 11920-23 Lahey Cholecystectomy Forcep, curved, longitudinal serrations, 230mm

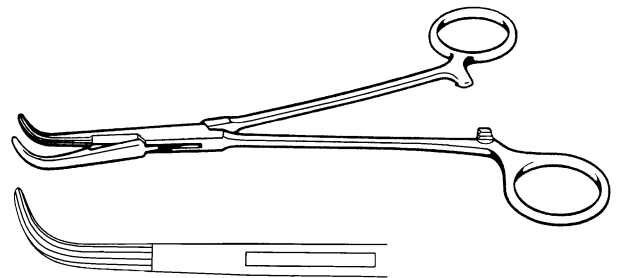

- 11930-21 Moynihan Cholecystectomy Forcep, curved on flat, box joint, 215mm

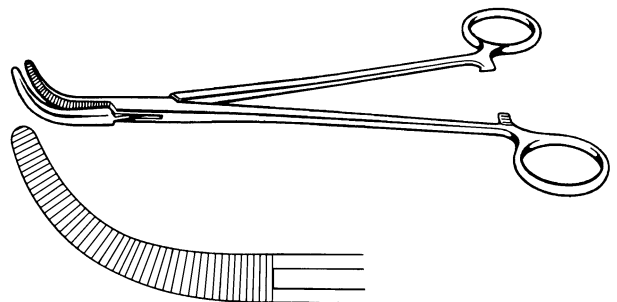

# General

## Clamps

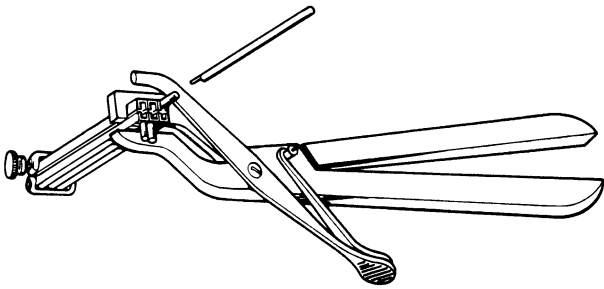

- 12010-10** De Martel Anastomosis Clamp, closing device only
- 12010-20** De Martel Anastomosis Clamp, segment clamp only
- 12010-30** De Martel Anastomosis Clamp, segment only
- 12010-40** De Martel Anastomosis Clamp, tommy bar only
- 12010-90** De Martel Anastomosis Clamp, complete with 3 segments, tommy bar and segment clamp

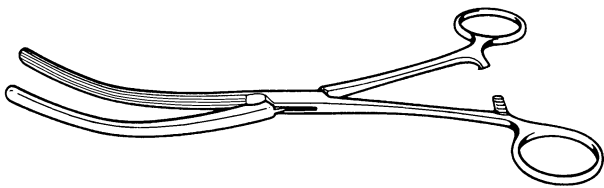

- 12020-17** Doyen Intestinal Clamp, curved, 170mm
- 12020-23** Doyen Intestinal Clamp, curved, 230mm

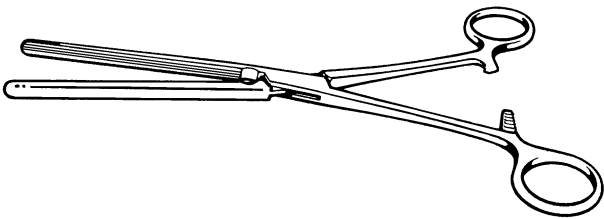

- 12030-17** Doyen Intestinal Clamp, straight, 170mm
- 12030-23** Doyen Intestinal Clamp, straight, 230mm



- 12040-23** Guard For Parker Kerr Clamp, fenestrated on inner curve, to suit 230mm clamp
- 12040-25** Guard For Parker Kerr Clamp, fenestrated on inner curve, to suit 255mm clamp



- 12050-23** Guard For Parker Kerr Clamp, fenestrated on outer curve, to suit 230mm clamp
- 12050-25** Guard For Parker Kerr Clamp, fenestrated on outer curve, to suit 255mm clamp

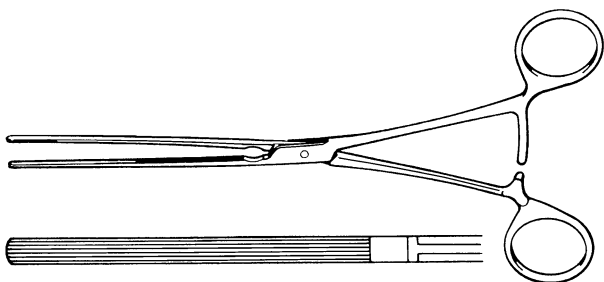

- 12060-10** Kocher Intestinal Clamp, curved, longitudinal serrations, 225mm, 100mm blades
- 12060-12** Kocher Intestinal Clamp, curved, longitudinal serrations, 250mm, 125mm blades
- 12060-15** Kocher Intestinal Clamp, curved, longitudinal serrations, 275mm, 150mm blades
- 12070-10** Kocher Intestinal Clamp, straight, longitudinal serrations, 225mm, 100mm blades
- 12070-12** Kocher Intestinal Clamp, straight, longitudinal serrations, 250mm, 125mm blades
- 12070-15** Kocher Intestinal Clamp, straight, longitudinal serrations, 275mm, 150mm blades

**12080-21** Lane Intestinal Clamp, straight, longitudinal serrations, 215mm, 75mm blades

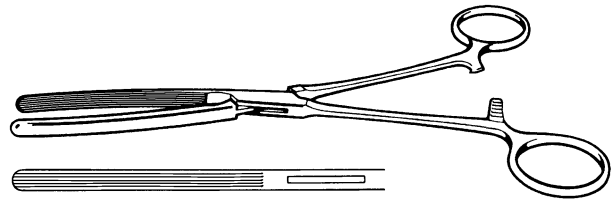

**12090-30** Lane Twin Clamp, curved, longitudinal serrations, large, 300mm

**12100-30** Lane Twin Clamp, straight, longitudinal serrations, large, 300mm

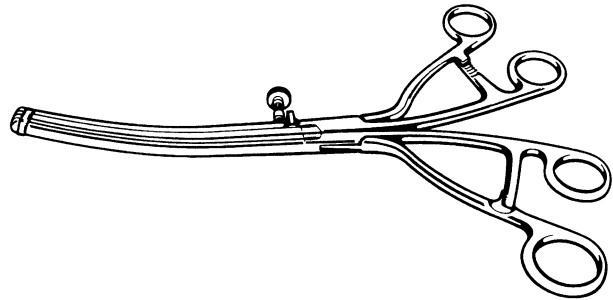

**12110-20** Lang Stevenson Clamp, keyed blades, 200mm, 80mm blades

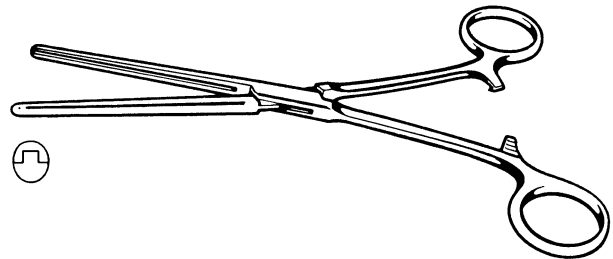

**12120-23** Parker Kerr Clamp, curved, screw joint, 230mm

**12120-25** Parker Kerr Clamp, curved, screw joint, 255mm

**12130-23** Parker Kerr Clamp, straight, screw joint, 230mm

**12130-25** Parker Kerr Clamp, straight, screw joint, 255mm

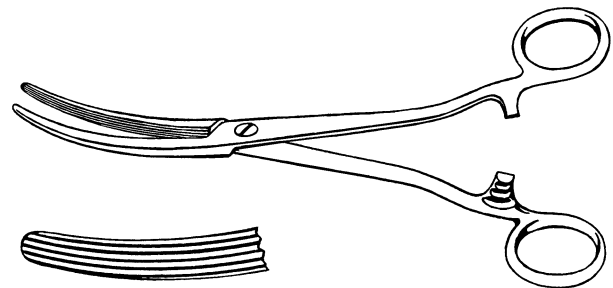

**12140-20** Payr Intestinal Clamp, lever action, longitudinal serrations, 200mm, 60mm blades

**12140-25** Payr Intestinal Clamp, lever action, longitudinal serrations, 255mm, 100mm blades

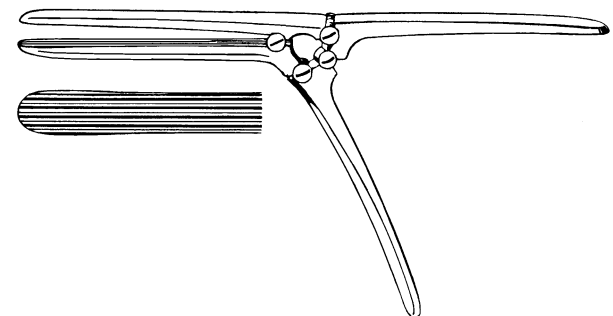

# General

## Clamps

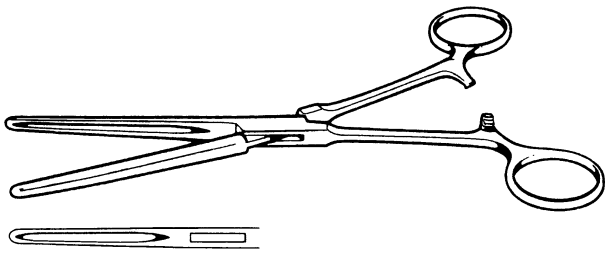

- 12150-17 Schoemaker-Ogilvie Clamp, straight, hollow blades, 170mm
- 12150-21 Schoemaker-Ogilvie Clamp, straight, hollow blades, 215mm

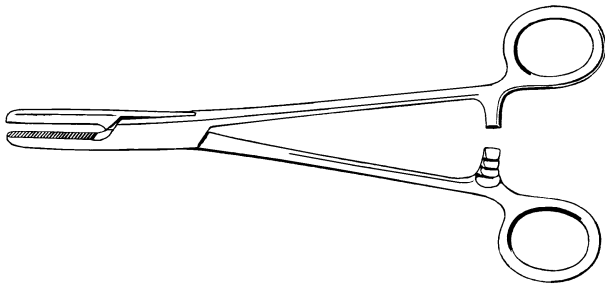

- 12160-14 Tubing Clamp, 145mm
- 12160-18 Tubing Clamp, 180mm

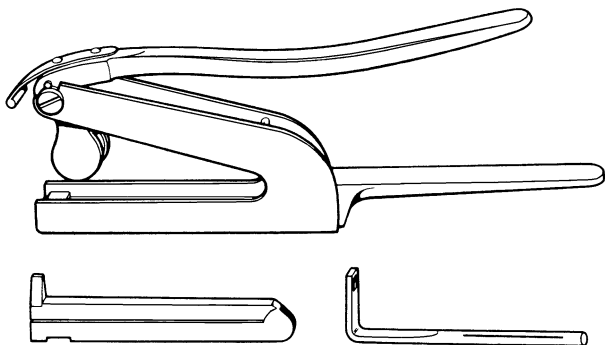

- 12170-10 Zachary Cope Anastomosis Clamp, closing device only
- 12170-20 Zachary Cope Anastomosis Clamp, segment only
- 12170-30 Zachary Cope Anastomosis Clamp, tommy bar only
- 12170-90 Zachary Cope Anastomosis Clamp, complete with 3 segments and tommy bar

## Clamps - Atraumatic

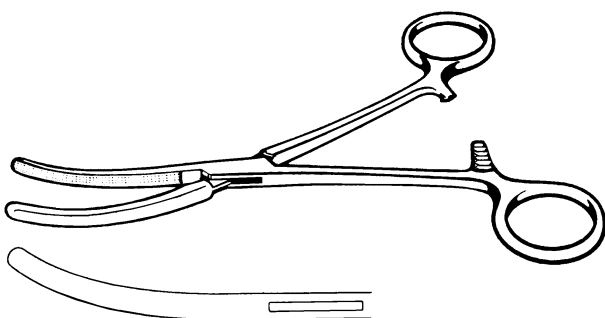

- 12200-18 Doyen Atraumatic Clamp, curved, 180mm



**Clamps - Atraumatic**

12200-23 Doyen Atraumatic Clamp, curved, 230mm

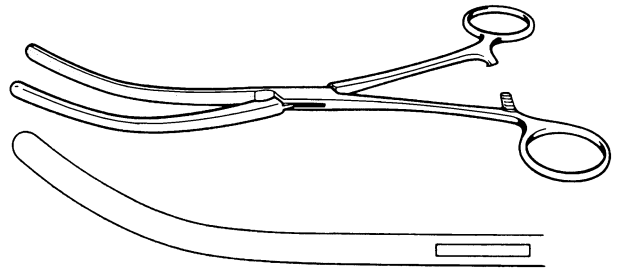

12210-18 Doyen Atraumatic Clamp, straight, 180mm

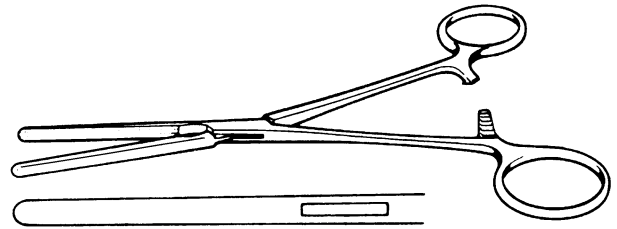

12210-23 Doyen Atraumatic Clamp, straight, 230mm

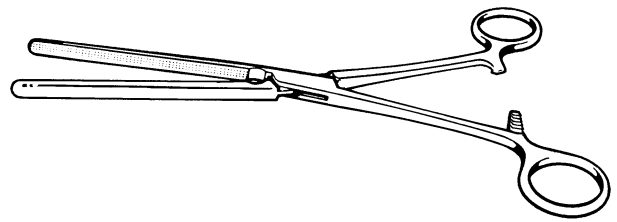

**Clip Forceps**

12300-14 Comyns Berkeley Clip Forcep, applying, serrated jaws, 140mm



12320-12 Michel Clip Forcep, applying and extracting combined, 125mm

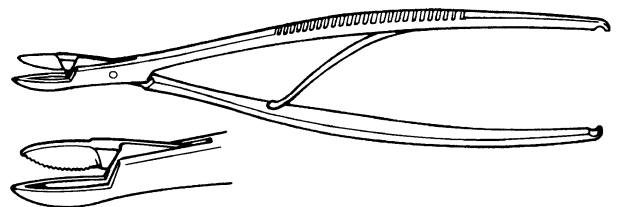

12340-12 Michel Clip Forcep, applying, 125mm



# General

## Clip Forceps

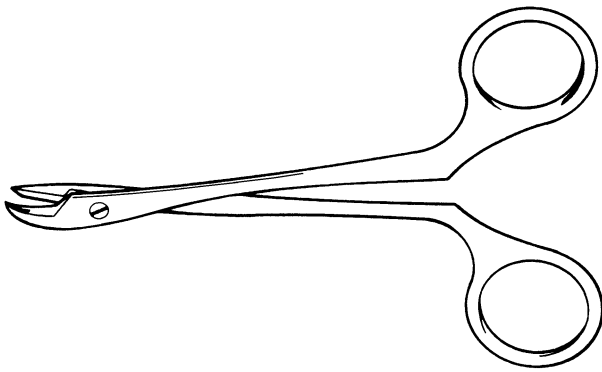

**12360-12** Michel Clip Forcep, clip extracting, 120mm

## Decompressors

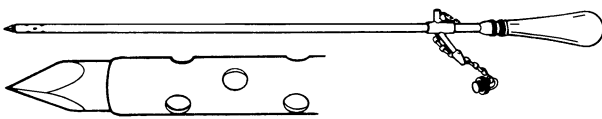

**12400-50** Savage Intestinal Decompressor, s/s, trocar and cannula, 8mm o.d., 500mm

## Depressors

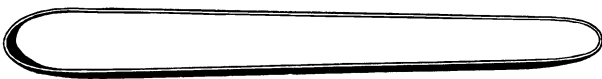

**12500-25** Sargent Intestinal Depressor, 250mm, 65mm wide to 40mm at narrow end

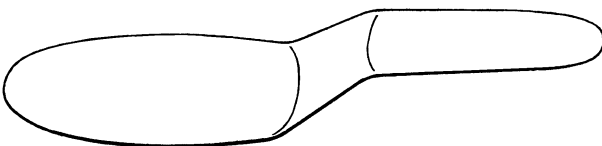

**12520-45** St.Barts Intestinal Depressor, 45mm x 28mm

## Diathermy Instruments

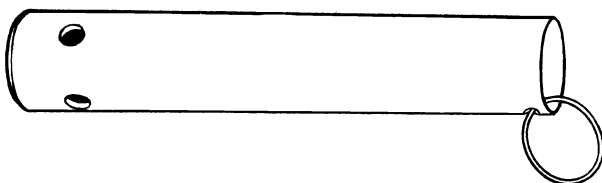

**13060-20** Diathermy Quiver, plastic with ring, 200mm, 65mm diameter

Dilators

- 13200-03** Bake Bile Duct Dilator, s/s, malleable stems, 200mm, 3mm diameter head
- 13200-04** Bake Bile Duct Dilator, s/s, malleable stems, 200mm, 4mm diameter head
- 13200-05** Bake Bile Duct Dilator, s/s, malleable stems, 200mm, 5mm diameter head
- 13200-06** Bake Bile Duct Dilator, s/s, malleable stems, 200mm, 6mm diameter head
- 13200-07** Bake Bile Duct Dilator, s/s, malleable stems, 200mm, 7mm diameter head
- 13200-08** Bake Bile Duct Dilator, s/s, malleable stems, 200mm, 8mm diameter head
- 13200-09** Bake Bile Duct Dilator, s/s, malleable stems, 200mm, 9mm diameter head
- 13200-10** Bake Bile Duct Dilator, s/s, malleable stems, 200mm, 10mm diameter head
- 13200-11** Bake Bile Duct Dilator, s/s, malleable stems, 200mm, 11mm diameter head
- 13200-90** Bake Bile Duct Dilator, s/s, malleable stems, 200mm, set of 9

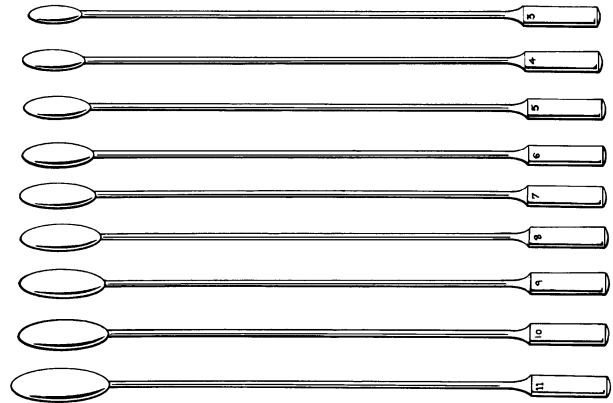

- 13205-03** Clarke Bile Duct Dilator, s/s, double ended, spiral wire stem, 230mm, 3/4mm
- 13205-05** Clarke Bile Duct Dilator, s/s, double ended, spiral wire stem, 230mm, 5/6mm
- 13205-07** Clarke Bile Duct Dilator, s/s, double ended, spiral wire stem, 230mm, 7/8mm

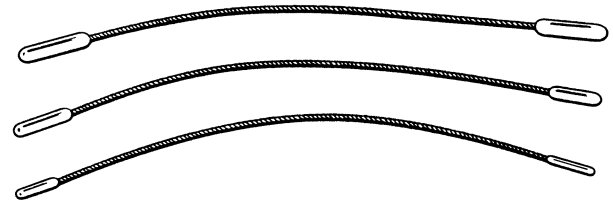

- 13220-04** Maingot Bile Duct Dilator, s/s, malleable stems, double ended, 180mm, 3mm and 4mm
- 13220-06** Maingot Bile Duct Dilator, s/s, malleable stems, double ended, 180mm, 5mm and 6mm
- 13220-08** Maingot Bile Duct Dilator, s/s, malleable stems, double ended, 180mm, 7mm and 8mm
- 13220-90** Maingot Bile Duct Dilator, s/s, malleable stems, double ended, 180mm, set of 3

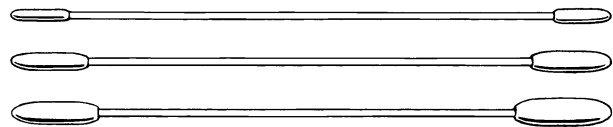

Directors

- 13300-14** Brodie Director, probe-ended, s/p, 140mm
- 13300-16** Brodie Director, probe-ended, s/p, 165mm
- 13300-20** Brodie Director, probe-ended, s/p, 200mm
- 13310-14** Brodie Director, probe-ended, silver, 140mm
- 13310-16** Brodie Director, probe-ended, silver, 165mm
- 13310-20** Brodie Director, probe-ended, silver, 200mm
- 13320-14** Brodie Director, probe-ended, s/s, 140mm
- 13320-16** Brodie Director, probe-ended, s/s, 165mm
- 13320-20** Brodie Director, probe-ended, s/s, 200mm



- 13340-15** Key Hernia Director, 155mm



# General

## Dissecting Forceps

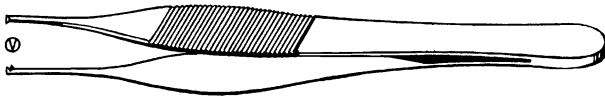

- 13400-12** Adson Dissecting Forcep, 1/2 teeth, 125mm
- 13410-12** Adson Dissecting Forcep, 1/2 teeth, fine, 125mm
- 13410-18** Adson Dissecting Forcep, 1/2 teeth, fine, 180mm
- 13415-18** Adson Dissecting Forcep, 1/2 teeth, ultra light, 180mm

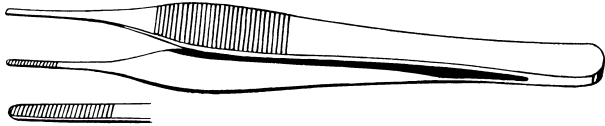

- 13420-12** Adson Dissecting Forcep, serrated, 125mm
- 13430-12** Adson Dissecting Forcep, serrated, fine, 125mm
- 13430-18** Adson Dissecting Forcep, serrated, fine, 180mm
- 13435-18** Adson Dissecting Forcep, serrated, ultra light, 180mm

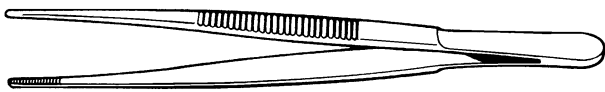

- 13440-12** Block End Dissecting Forcep, round serrated jaws, narrow flutes, 125mm
- 13440-15** Block End Dissecting Forcep, round serrated jaws, narrow flutes, 150mm
- 13440-18** Block End Dissecting Forcep, round serrated jaws, narrow flutes, 180mm
- 13440-20** Block End Dissecting Forcep, round serrated jaws, narrow flutes, 200mm
- 13440-25** Block End Dissecting Forcep, round serrated jaws, narrow flutes, 250mm

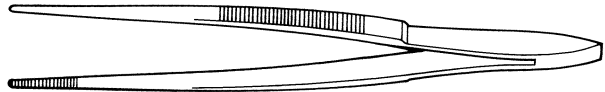

- 13441-15** Block End Dissecting Forcep, fine serrated jaws, narrow flutes, 150mm
- 13441-18** Block End Dissecting Forcep, fine serrated jaws, narrow flutes, 180mm
- 13441-20** Block End Dissecting Forcep, fine serrated jaws, narrow flutes, 200mm

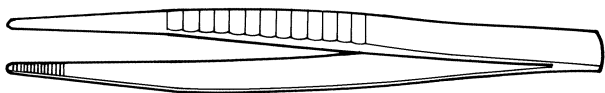

- 13442-12** Block End Dissecting Forcep, serrated jaws, broad flutes, 125mm
- 13442-15** Block End Dissecting Forcep, serrated jaws, broad flutes, 150mm
- 13442-18** Block End Dissecting Forcep, serrated jaws, broad flutes, 180mm
- 13442-20** Block End Dissecting Forcep, serrated jaws, broad flutes, 200mm
- 13442-25** Block End Dissecting Forcep, serrated jaws, broad flutes, 250mm
- 13442-30** Block End Dissecting Forcep, serrated jaws, broad flutes, 300mm

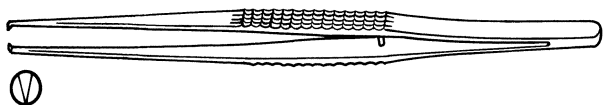

- 13445-23** Bickford Dissecting Forcep, 1/2 teeth, 230mm

**Dissecting Forceps**

**13446-23** Bickford Dissecting Forcep, serrated jaws, 230mm

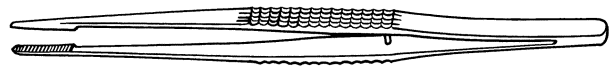

**13450-18** Bonney Dissecting Forcep, 1/2 teeth, 180mm

**13460-18** Bonney Dissecting Forcep, serrated, 180mm

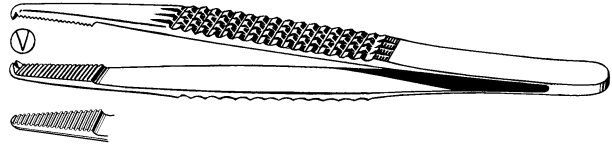

**13465-14** Braithwaite Dissecting Forcep, 1/2 teeth, 140mm

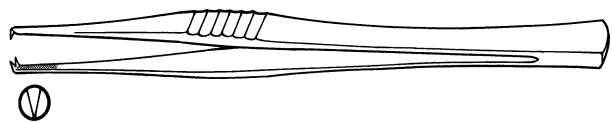

**13470-14** Canadian Dissecting Forcep, 2/3 teeth, 140mm

**13470-15** Canadian Dissecting Forcep, 2/3 teeth, 150mm

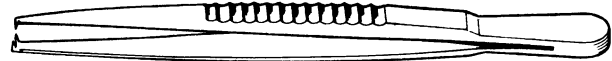

**13480-14** Canadian Dissecting Forcep, serrated jaws, 140mm

**13480-15** Canadian Dissecting Forcep, serrated jaws, 150mm



**13490-10** Continental Pattern Dissecting Forcep, 1/2 teeth, 105mm

**13490-12** Continental Pattern Dissecting Forcep, 1/2 teeth, 125mm

**13490-15** Continental Pattern Dissecting Forcep, 1/2 teeth, 150mm

**13490-16** Continental Pattern Dissecting Forcep, 1/2 teeth, 160mm

**13490-17** Continental Pattern Dissecting Forcep, 1/2 teeth, 175mm

**13490-20** Continental Pattern Dissecting Forcep, 1/2 teeth, 200mm

**13490-25** Continental Pattern Dissecting Forcep, 1/2 teeth, 250mm

**13490-30** Continental Pattern Dissecting Forcep, 1/2 teeth, 300mm

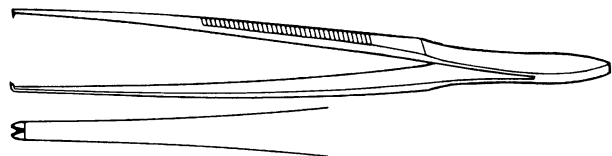

**13510-20** Emmett Dissecting Forcep, serrated jaws, 200mm



# General

## Dissecting Forceps

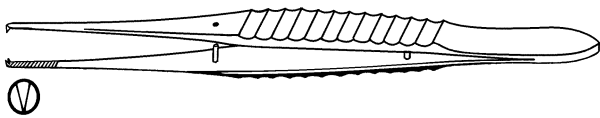

**13520-15** Gillies Dissecting Forcep, 1/2 teeth, 150mm

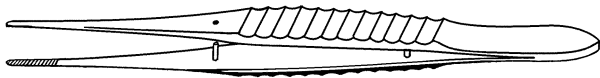

**13521-15** Gillies Dissecting Forcep, serrated jaws, 150mm

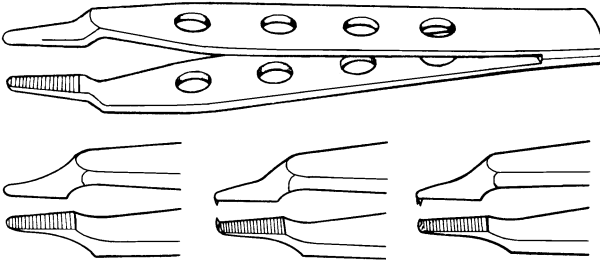

**13530-14** Jeans Dissecting Forcep, 1/2 teeth, 140mm  
**13530-18** Jeans Dissecting Forcep, 1/2 teeth, 180mm  
**13540-18** Jeans Dissecting Forcep, 2/3 teeth, 180mm  
**13550-14** Jeans Dissecting Forcep, serrated jaws, 140mm

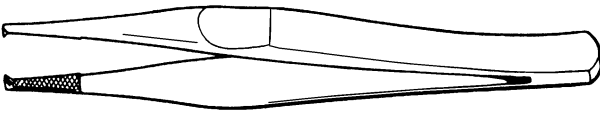

**13560-12** Lanes Dissecting Forcep, 1/2 teeth, 125mm  
**13560-14** Lanes Dissecting Forcep, 1/2 teeth, 140mm  
**13560-18** Lanes Dissecting Forcep, 1/2 teeth, 180mm  
**13560-20** Lanes Dissecting Forcep, 1/2 teeth, 200mm



**13570-12** Lanes Dissecting Forcep, 2/3 teeth, 125mm  
**13570-14** Lanes Dissecting Forcep, 2/3 teeth, 140mm  
**13570-18** Lanes Dissecting Forcep, 2/3 teeth, 180mm  
**13570-20** Lanes Dissecting Forcep, 2/3 teeth, 200mm



**13580-14** Leedham Green Dissecting Forcep, 2/3 teeth, 145mm



**13590-14** Leedham Green Dissecting Forcep, 3/4 teeth, 145mm

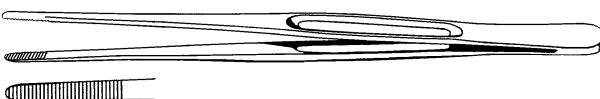

**13600-28** Maingot Dissecting Forcep, straight, serrated tips, fenestrated grip, 280mm

**Dissecting Forceps**

**13610-15** McIndoe Dissecting Forcep, 1/2 teeth, 150mm



**13620-15** McIndoe Dissecting Forcep, serrated, 150mm



**13640-18** Ramsey Dissecting Forcep, 1/2 teeth, 180mm

**13650-18** Ramsey Dissecting Forcep, 2/3 teeth, 180mm

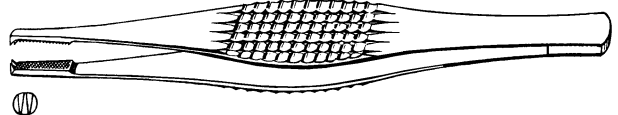

**13660-18** Ramsey Dissecting Forcep, serrated, 180mm

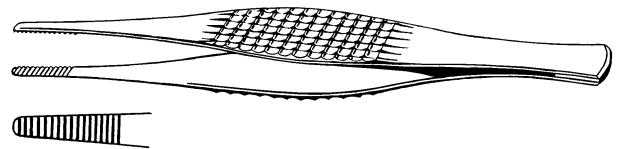

**13670-29** St.Marks Dissecting Forcep, 1/2 teeth, 290mm

**13680-29** St.Marks Dissecting Forcep, serrated, 290mm

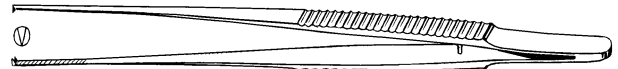

**13690-12** Treves Dissecting Forcep, 1/2 teeth, 125mm

**13690-15** Treves Dissecting Forcep, 1/2 teeth, 150mm

**13690-18** Treves Dissecting Forcep, 1/2 teeth, 180mm

**13690-20** Treves Dissecting Forcep, 1/2 teeth, 200mm

**13690-25** Treves Dissecting Forcep, 1/2 teeth, 250mm



**13700-12** Turn-Over-End Dissecting Forcep, serrated jaws, broad flutes, 125mm

**13700-15** Turn-Over-End Dissecting Forcep, serrated jaws, broad flutes, 150mm



**13710-15** Waugh Dissecting Forcep, 1/2 teeth, 150mm

**13710-18** Waugh Dissecting Forcep, 1/2 teeth, 180mm

**13710-20** Waugh Dissecting Forcep, 1/2 teeth, 200mm

**13720-15** Waugh Dissecting Forcep, serrated jaws, 150mm

**13720-18** Waugh Dissecting Forcep, serrated jaws, 180mm

**13720-20** Waugh Dissecting Forcep, serrated jaws, 200mm



# General

## Dissectors



**13900-19** Durham Dissector, double ended, 190mm



**13910-16** Kocher Thyroid Dissector, curved, 160mm



**13920-16** Kocher Thyroid Dissector, curved, 165mm



**13930-18** Kocher Thyroid Dissector, curved, 180mm

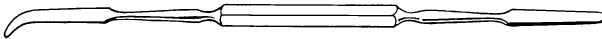

**13940-19** MacDonald Dissector, double ended, 190mm

**13940-25** MacDonald Dissector, double ended, 250mm

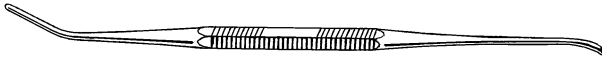

**13950-12** Watson Cheyne Dissector, fine with probe, 125mm

**13950-18** Watson Cheyne Dissector, fine with probe, 180mm

## Dressing Forceps

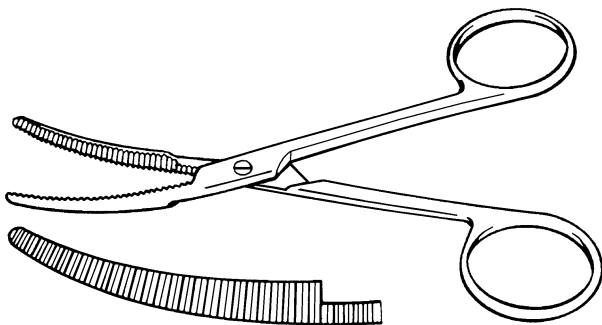

**14000-12** Bryant Dressing Forcep, serrated jaws, box joint, 125mm

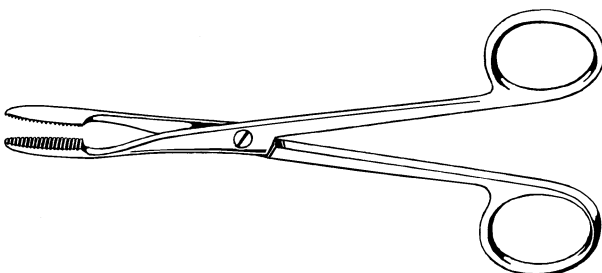

**14020-12** French Bow Dressing Forcep, screw joint, 125mm



Hernia Forceps

14300-14 Collingwood Stewart Hernia Forcep, ring bladed, screw joint, 140mm

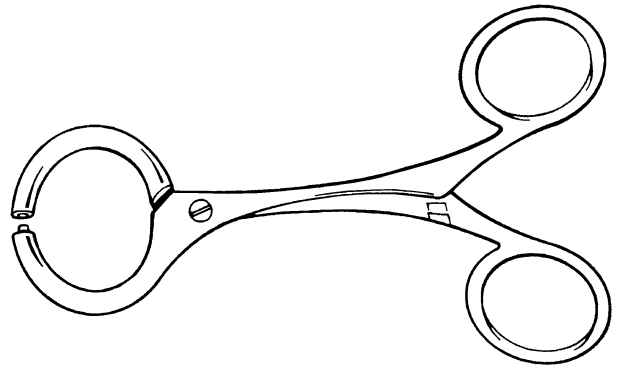

Instrument Pins

14400-10 Mayo Instrument Pin, with ball end, 100mm

14400-15 Mayo Instrument Pin, with ball end, 150mm

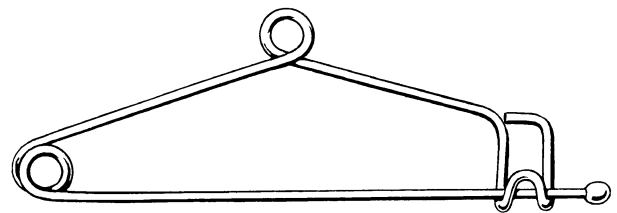

Intestinal Forceps

14500-19 Denis Brown Intestinal Forcep, 190mm

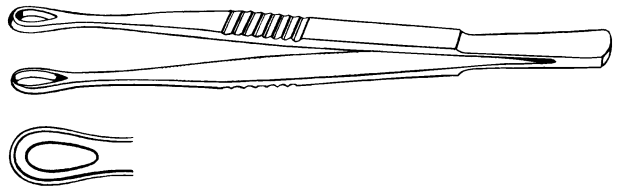

Introducing Forceps

14600-19 Magill Introducing Forcep, screw joint, child, 190mm

14600-23 Magill Introducing Forcep, screw joint, adult, 230mm

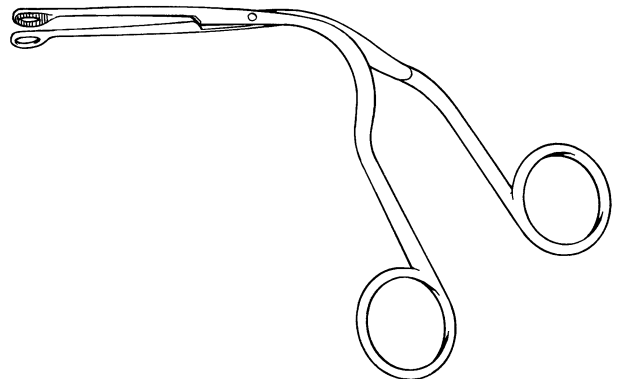

# General

## Knives

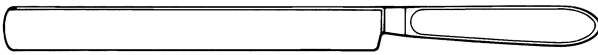

- 14750-20 Brain Knife, solid forged, 200mm blade
- 14750-22 Brain Knife, solid forged, 225mm blade
- 14750-25 Brain Knife, solid forged, 250mm blade
- 14750-30 Brain Knife, solid forged, 300mm blade



- 14760-20 Cartilage Knife, solid forged, 200mm, 70mm blade
- 14760-21 Cartilage Knife, solid forged, 215mm, 90mm blade



- 14770-10 Liston Amputation Knife, solid forged, 100mm blade
- 14770-12 Liston Amputation Knife, solid forged, 125mm blade
- 14770-15 Liston Amputation Knife, solid forged, 150mm blade
- 14770-18 Liston Amputation Knife, solid forged, 180mm blade

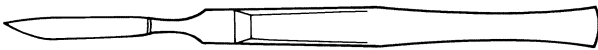

- 14780-14 Paget Knife, 140mm

## Measures



- 15000-15 Stainless Steel Rule, 150mm
- 15000-30 Stainless Steel Rule, 300mm

## Mouth Gags

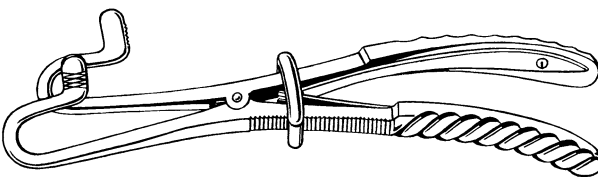

- 15110-17 Ferguson Mouth Gag, Ackland jaw, child, 170mm
- 15110-20 Ferguson Mouth Gag, Ackland jaw, adult, 200mm

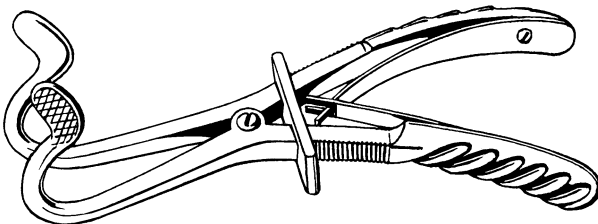

- 15120-17 Ferguson Mouth Gag, ordinary jaw, child, 170mm
- 15120-20 Ferguson Mouth Gag, ordinary jaw, adult, 200mm

Needleholders

**15200-20** Bozemann Needleholder, double curve, serrated jaws, 200mm

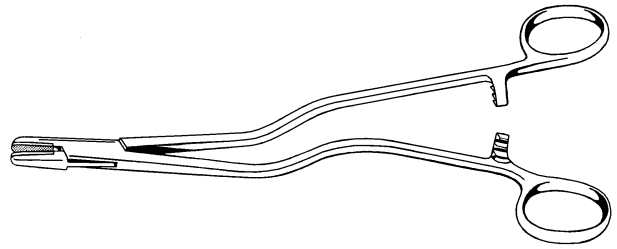

- 15210-15** Crile Wood Needleholder, serrated jaws, 150mm
- 15210-18** Crile Wood Needleholder, serrated jaws, 180mm
- 15210-20** Crile Wood Needleholder, serrated jaws, 200mm
- 15210-23** Crile Wood Needleholder, serrated jaws, 230mm
- 15210-25** Crile Wood Needleholder, serrated jaws, 255mm
- 15210-30** Crile Wood Needleholder, serrated jaws, 305mm

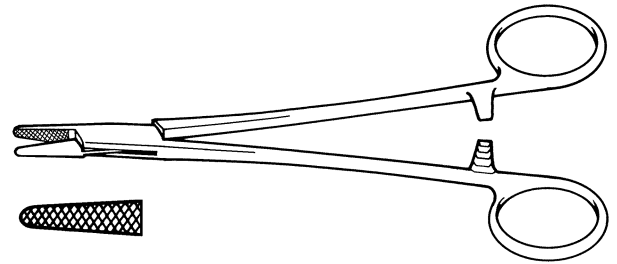

**15220-14** Crile-Murray Needleholder, serrated jaws, 145mm

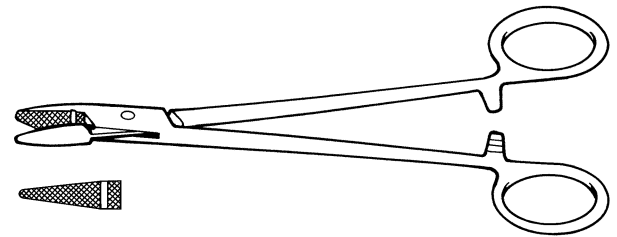

**15230-12** Derf Needleholder, serrated jaws, 120mm

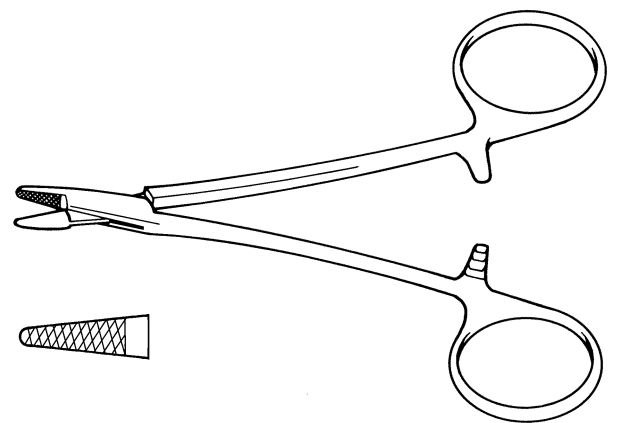

# General

## Needleholders

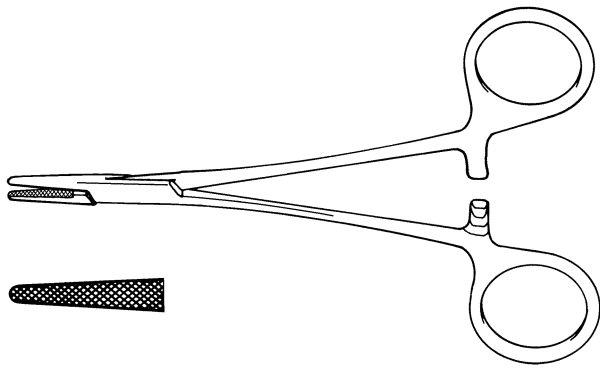

**15240-12** Halsey Needleholder, serrated jaws, 125mm

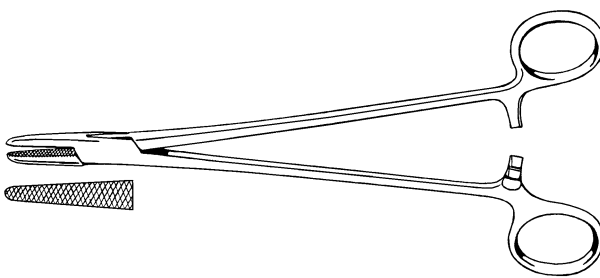

**15250-20** Hegar Needleholder, serrated jaws, 200mm

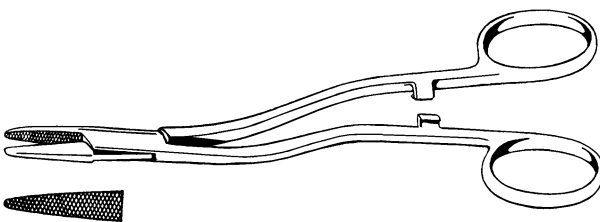

**15260-13** Kilner Needleholder, serrated jaws, 135mm  
**15260-16** Kilner Needleholder, serrated jaws, 165mm

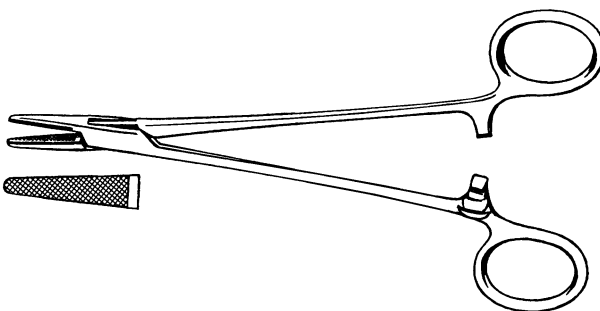

**15270-15** Lawrance Needleholder, lightweight, serrated jaws, 150mm

Needleholders

- 15280-15 Macphail Needleholder, screw joint with copper jaws, 150mm
- 15280-18 Macphail Needleholder, screw joint with copper jaws, 180mm
- 15280-20 Macphail Needleholder, screw joint with copper jaws, 200mm

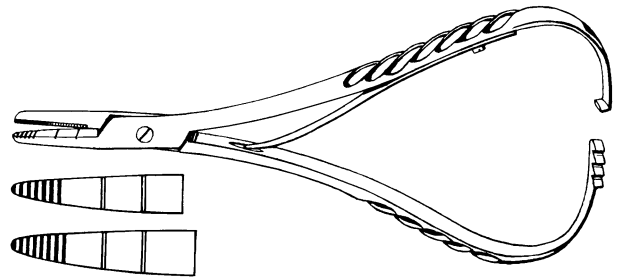

- 15290-17 Mathieu Needleholder, serrated jaws, 170mm
- 15290-20 Mathieu Needleholder, serrated jaws, 200mm

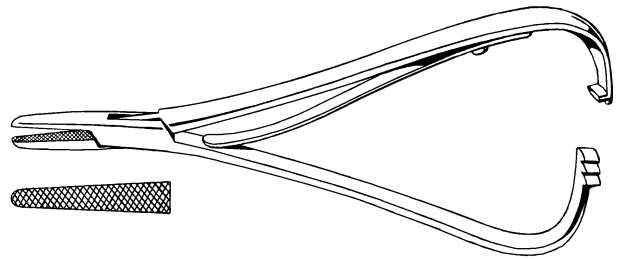

- 15300-15 Mayo Needleholder, light pattern, serrated jaws, 150mm

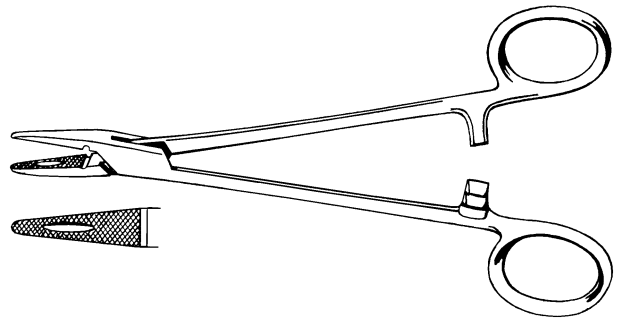

- 15310-12 Mayo Needleholder, wide serrated jaws, 125mm
- 15310-14 Mayo Needleholder, wide serrated jaws, 140mm
- 15310-16 Mayo Needleholder, wide serrated jaws, 160mm
- 15310-18 Mayo Needleholder, wide serrated jaws, 185mm
- 15310-20 Mayo Needleholder, wide serrated jaws, 200mm
- 15310-23 Mayo Needleholder, wide serrated jaws, 230mm
- 15310-25 Mayo Needleholder, wide serrated jaws, 255mm
- 15310-30 Mayo Needleholder, wide serrated jaws, 305mm

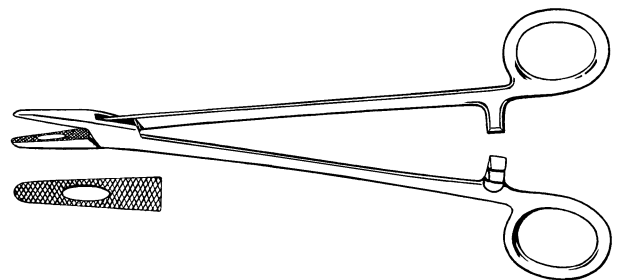

# General

## Needleholders

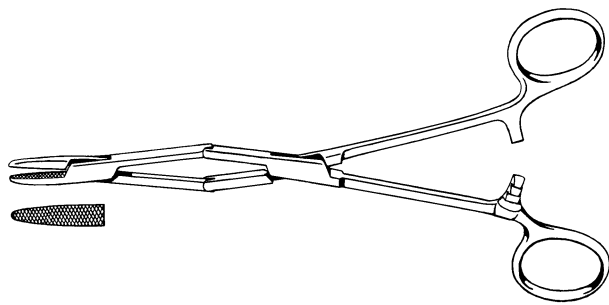

- 15320-18** Naunton Morgan Needleholder, compound action, serrated jaws, 185mm
- 15320-25** Naunton Morgan Needleholder, compound action, serrated jaws, 250mm

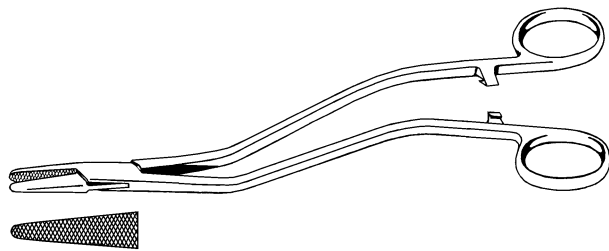

- 15330-20** Thomson-Walker Needleholder, serrated jaws, 200mm

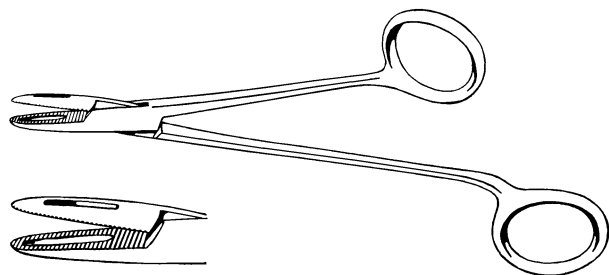

- 15340-18** Ward Needleholder, serrated, fenestrated jaws, 180mm

## Needleholders - Tungsten Carbide

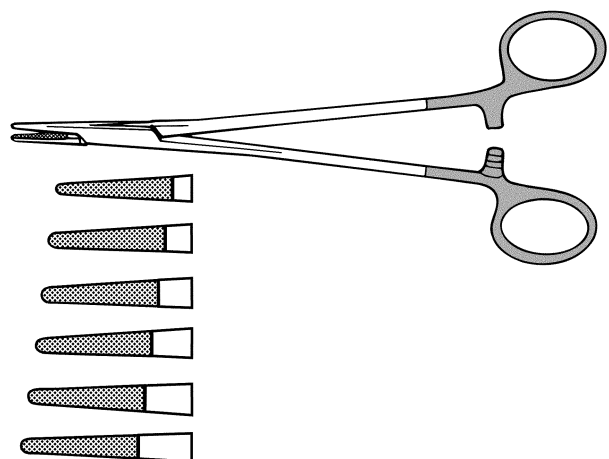

- 15400-15** Crile Wood Needleholder, tungsten carbide, 150mm
- 15400-18** Crile Wood Needleholder, tungsten carbide, 180mm
- 15400-20** Crile Wood Needleholder, tungsten carbide, 200mm
- 15400-23** Crile Wood Needleholder, tungsten carbide, 230mm
- 15400-25** Crile Wood Needleholder, tungsten carbide, 255mm
- 15400-30** Crile Wood Needleholder, tungsten carbide, 305mm

**Needleholders - Tungsten Carbide**

- 15410-18** DeBakey Needleholder, tungsten carbide, 180mm
- 15410-20** DeBakey Needleholder, tungsten carbide, 200mm
- 15410-23** DeBakey Needleholder, tungsten carbide, 230mm
- 15410-25** DeBakey Needleholder, tungsten carbide, 250mm
- 15410-30** DeBakey Needleholder, tungsten carbide, 305mm

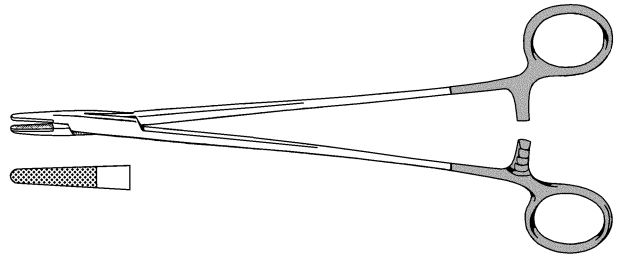

- 15420-12** Derf Needleholder, tungsten carbide, 120mm

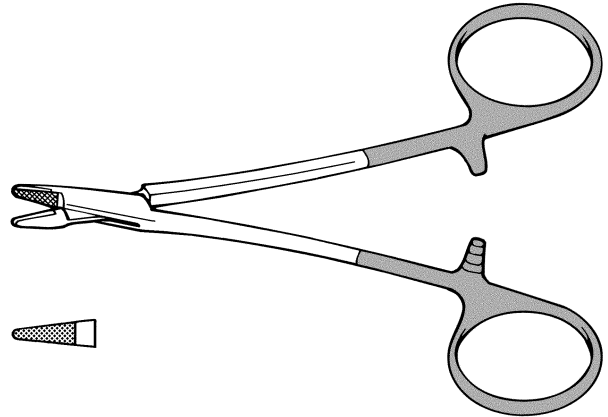

- 15430-20** Finochietto Needleholder, tungsten carbide, 200mm
- 15430-26** Finochietto Needleholder, tungsten carbide, 265mm

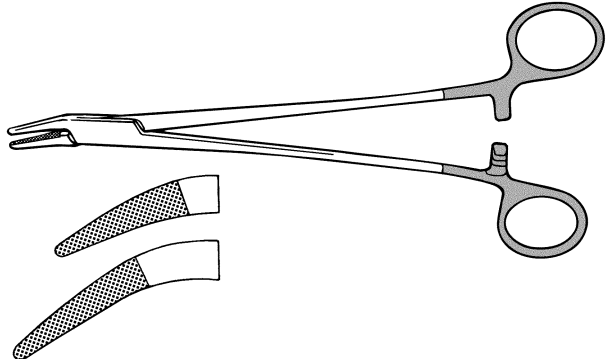

- 15440-12** Halsey Needleholder, tungsten carbide, 125mm

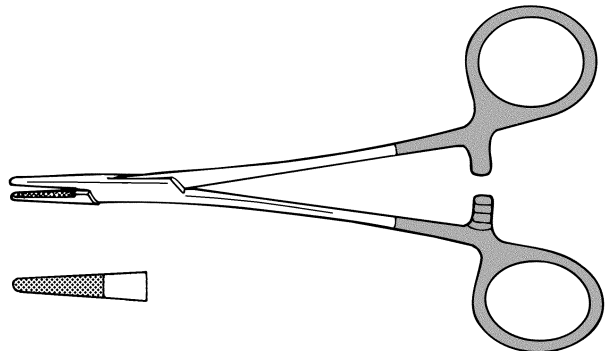

# General

## Needleholders - Tungsten Carbide

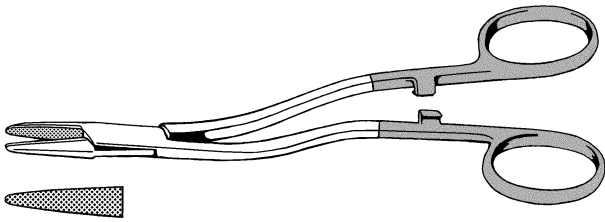

- 15460-13** Kilner Needleholder, tungsten carbide, 135mm
- 15460-16** Kilner Needleholder, tungsten carbide, 165mm

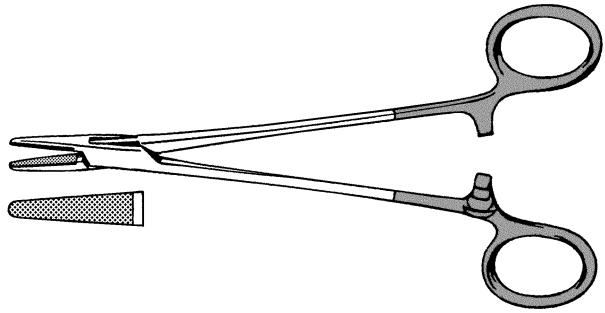

- 15470-15** Lawrance Needleholder, tungsten carbide, 150mm

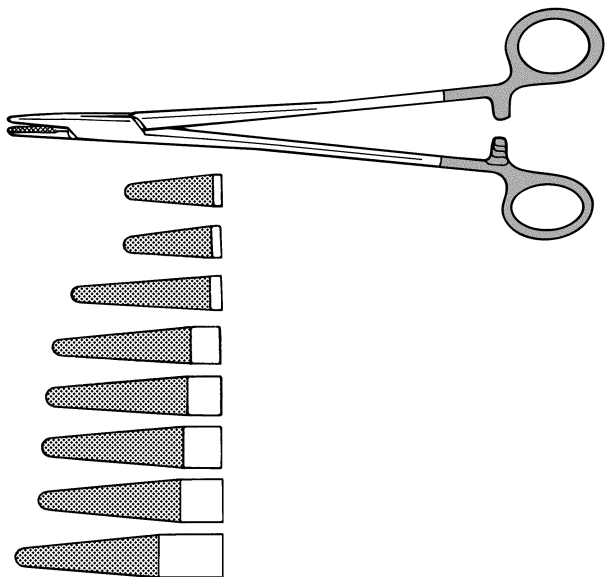

- 15490-12** Mayo Needleholder, tungsten carbide, 125mm
- 15490-14** Mayo Needleholder, tungsten carbide, 140mm
- 15490-16** Mayo Needleholder, tungsten carbide, 160mm
- 15490-18** Mayo Needleholder, tungsten carbide, 185mm
- 15490-20** Mayo Needleholder, tungsten carbide, 200mm
- 15490-23** Mayo Needleholder, tungsten carbide, 230mm
- 15490-25** Mayo Needleholder, tungsten carbide, 255mm
- 15490-30** Mayo Needleholder, tungsten carbide, 305mm

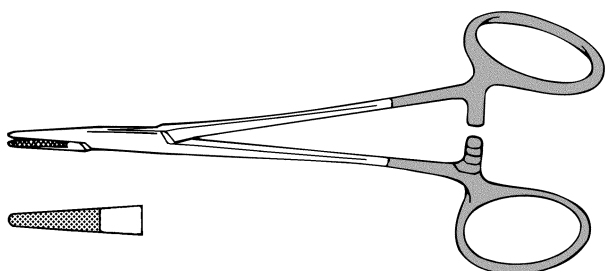

- 15495-12** Neivert Needleholder, tungsten carbide, 125mm



**Needleholders - Tungsten Carbide**

- 15500-12** Ryder Needleholder, french eye, tungsten carbide, 125mm
- 15500-15** Ryder Needleholder, french eye, tungsten carbide, 150mm
- 15500-18** Ryder Needleholder, french eye, tungsten carbide, 180mm
- 15500-20** Ryder Needleholder, french eye, tungsten carbide, 200mm
- 15500-23** Ryder Needleholder, french eye, tungsten carbide, 230mm
- 15500-25** Ryder Needleholder, french eye, tungsten carbide, 255mm

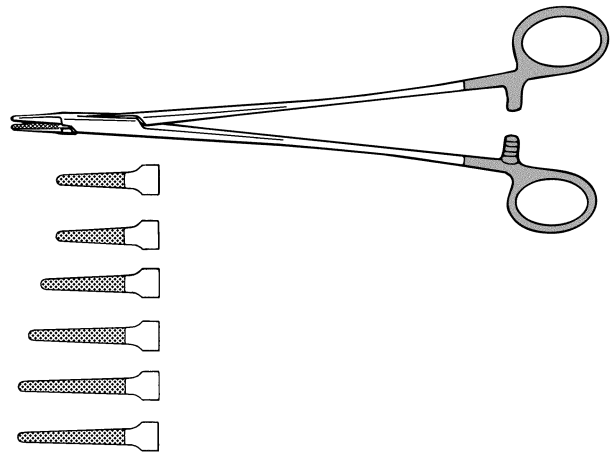

**Needles**

- 15600-14** Aneurysm Needle, small curve, 145mm

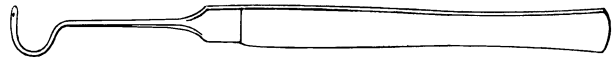

- 15610-21** Bonney Reverdin Needle, handle only, standard model, without needles, 210mm

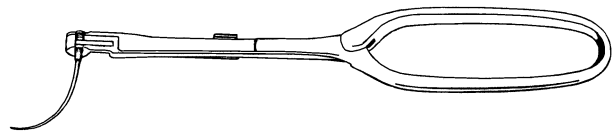

- 15620-20** Bonney Reverdin Needle, blunt, medium
- 15630-10** Bonney Reverdin Needle, sharp, large
- 15630-20** Bonney Reverdin Needle, sharp, medium
- 15630-30** Bonney Reverdin Needle, sharp, small

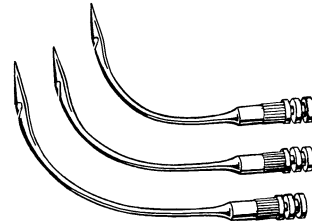

- 15640-19** Cooper Needle, 190mm



- 15650-27** Deschamps Needle, curved to left, 270mm

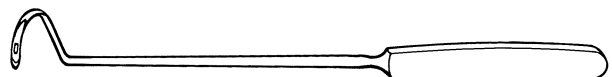

- 15660-27** Deschamps Needle, curved to right, 270mm

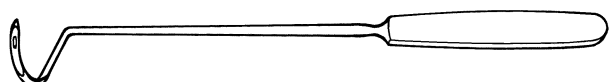

# General

## Needles

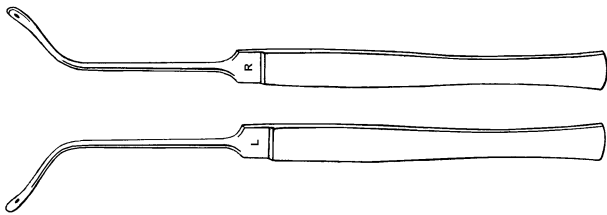

- 15670-17** Dupuytren Needle, curved to left, 170mm  
**15680-17** Dupuytren Needle, curved to right, 170mm

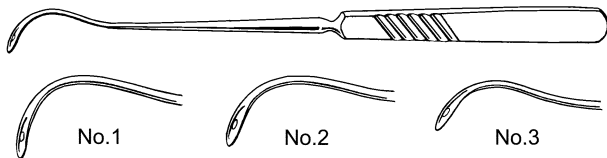

- 15690-10** Jolls Aneurysm Needle, 200mm, No.1  
**15690-20** Jolls Aneurysm Needle, 200mm, No.2  
**15690-30** Jolls Aneurysm Needle, 200mm, No.3

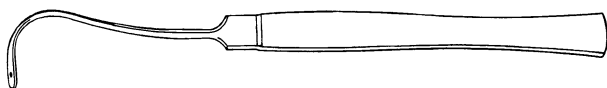

- 15700-16** Symes Needle, 165mm

## Percussors

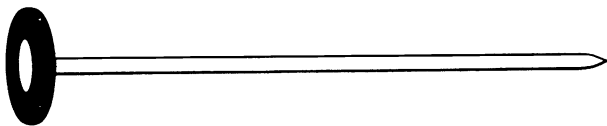

- 15800-33** National Hospital Percussor, nylon handle, large rubber ring, 70mm diameter, 335mm

## Plaster Instruments

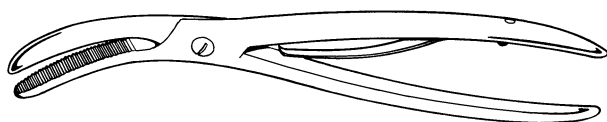

- 15900-25** Bohler Bender, 255mm

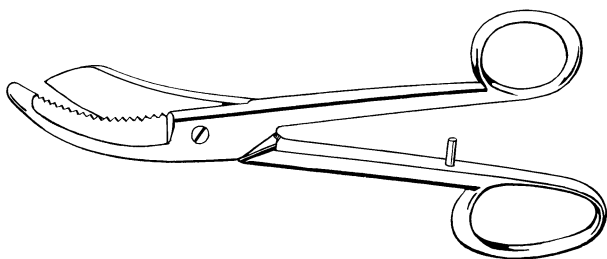

- 15910-24** Bruns / Bohler Plaster Shears, saw edge, 240mm

**Plaster Instruments**

15920-25 Guys Plaster Shears, flattened end, 250mm

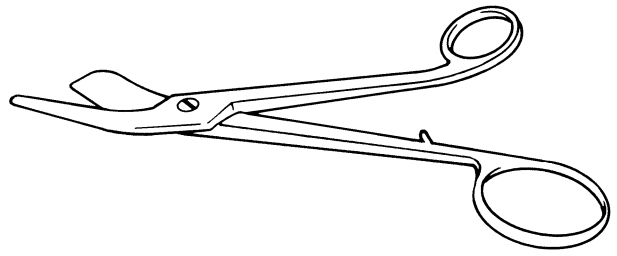

15930-29 Guys Plaster Shears, probe end, 290mm

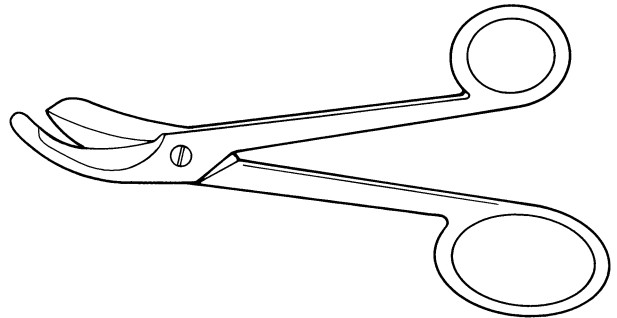

15940-28 Hennig Spreader, 280mm

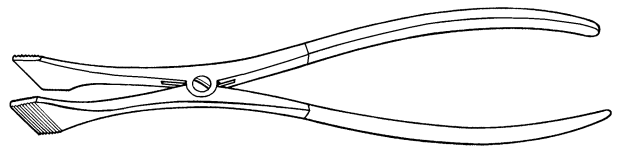

15960-23 Stille-Lorenz Plaster Shears, 230mm

15960-26 Stille-Lorenz Plaster Shears, 260mm

15960-37 Stille-Lorenz Plaster Shears, 370mm

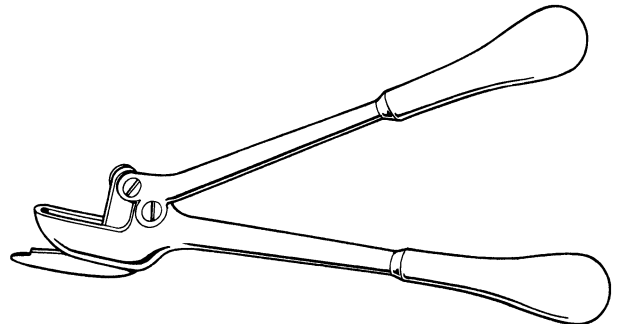

**Probes**

16030-35 Moynihan Gallstone Probe And Scoop, malleable, 350mm



# General

## Probes



- 16040-12** Nickel Silver Probe With Eye, 125mm
- 16040-15** Nickel Silver Probe With Eye, 150mm
- 16040-18** Nickel Silver Probe With Eye, 180mm
- 16040-20** Nickel Silver Probe With Eye, 205mm
- 16040-23** Nickel Silver Probe With Eye, 230mm
- 16040-25** Nickel Silver Probe With Eye, 255mm
- 16040-30** Nickel Silver Probe With Eye, 305mm
- 16045-12** Silver Probe With Eye, 125mm
- 16045-15** Silver Probe With Eye, 150mm
- 16045-18** Silver Probe With Eye, 180mm
- 16045-20** Silver Probe With Eye, 205mm
- 16045-23** Silver Probe With Eye, 230mm
- 16045-25** Silver Probe With Eye, 255mm
- 16045-30** Silver Probe With Eye, 305mm



- 16050-15** Sinus Probe, silver, 150mm

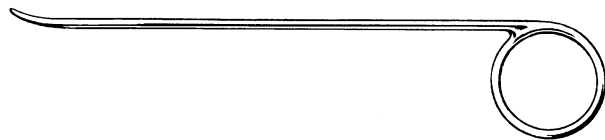

- 16060-10** Stacke Probe, 105mm

## Retractors

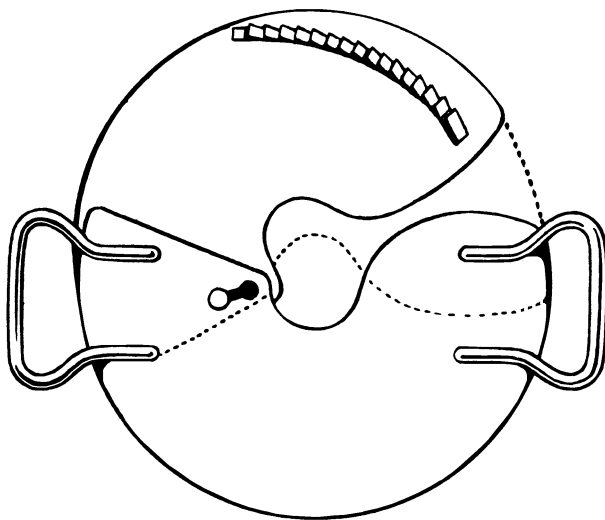

- 16100-24** Blake Amputation Flap Retractor, 240mm diameter

- 16105-70** Broomhead Psoas Retractor, 250mm, 22mm wide x 70mm deep blade
- 16105-90** Broomhead Psoas Retractor, 250mm, 28mm wide x 90mm deep blade

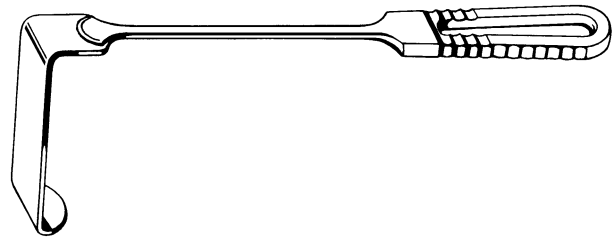

- 16110-10** Canny Ryall Army Pattern Retractor, large single blunt hook, small double blunt hook
- 16110-20** Canny Ryall Army Pattern Retractor, small single blunt hook, large double blunt hook

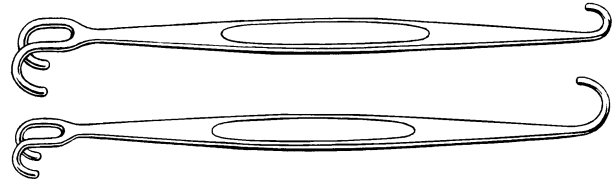

- 16120-15** Canny Ryall Navy Pattern Retractor, single hook 5mm wide, fenestrated blade 15mm wide
- 16120-20** Canny Ryall Navy Pattern Retractor, single hook 5mm wide, fenestrated blade 20mm wide
- 16120-25** Canny Ryall Navy Pattern Retractor, single hook 5mm wide, fenestrated blade 25mm wide
- 16120-30** Canny Ryall Navy Pattern Retractor, single hook 5mm wide, fenestrated blade 30mm wide

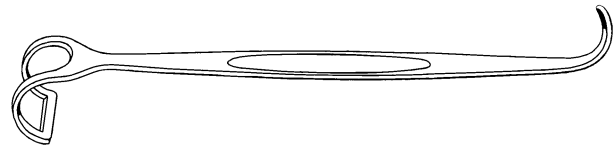

- 16130-18** Czerny Retractor, double ended, 180mm

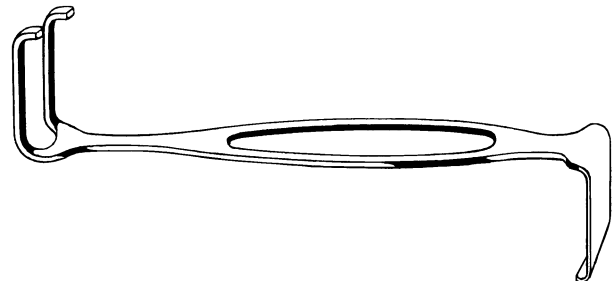

- 16140-02** Deaver Abdominal Retractor, flat handle, No.00, 230mm, 25mm blade
- 16140-05** Deaver Abdominal Retractor, flat handle, No.0, 250mm, 25mm blade
- 16140-10** Deaver Abdominal Retractor, flat handle, No.1, 305mm, 25mm blade
- 16140-20** Deaver Abdominal Retractor, flat handle, No.2, 330mm, 25mm blade
- 16140-30** Deaver Abdominal Retractor, flat handle, No.3, 305mm, 38mm blade
- 16140-40** Deaver Abdominal Retractor, flat handle, No.4, 305mm, 50mm blade
- 16140-50** Deaver Abdominal Retractor, flat handle, No.5, 305mm, 75mm blade
- 16140-90** Deaver Abdominal Retractor, flat handle, 305mm, set of 5 (No.1 - No.5)

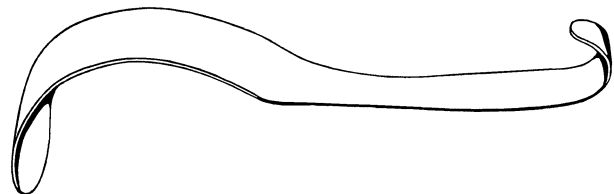

# General

## Retractors

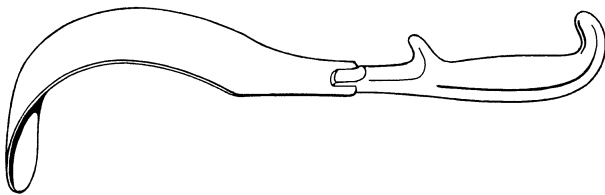

- 16150-02** Deaver Abdominal Retractor, hollow handle, No.00, 230mm, 25mm blade
- 16150-05** Deaver Abdominal Retractor, hollow handle, No.0, 250mm, 25mm blade
- 16150-10** Deaver Abdominal Retractor, hollow handle, No.1, 305mm, 25mm blade
- 16150-20** Deaver Abdominal Retractor, hollow handle, No.2, 330mm, 25mm blade
- 16150-30** Deaver Abdominal Retractor, hollow handle, No.3, 305mm, 38mm blade
- 16150-40** Deaver Abdominal Retractor, hollow handle, No.4, 305mm, 50mm blade
- 16150-50** Deaver Abdominal Retractor, hollow handle, No.5, 305mm, 75mm blade
- 16150-90** Deaver Abdominal Retractor, hollow handle, 305mm, set of 5 (No.1 - No.5)

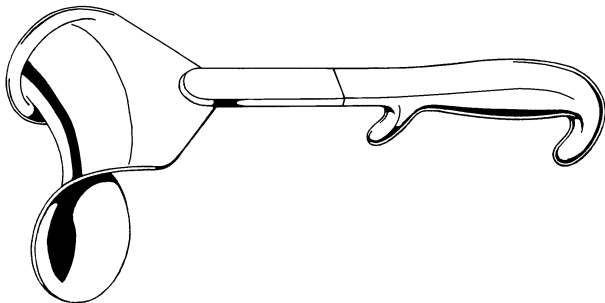

- 16160-09** Doyen Retractor, on hollow handle, 90mm wide blade
- 16160-10** Doyen Retractor, on hollow handle, 100mm wide blade
- 16160-11** Doyen Retractor, on hollow handle, 115mm wide blade

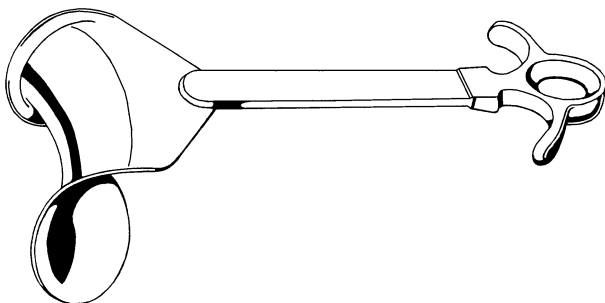

- 16170-09** Doyen Retractor, on solid handle, 90mm wide blade
- 16170-10** Doyen Retractor, on solid handle, 100mm wide blade
- 16170-11** Doyen Retractor, on solid handle, 115mm wide blade

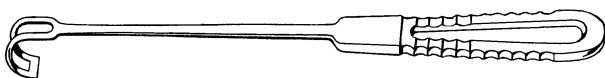

- 16180-10** Durham Retractor, 10mm blade
- 16180-16** Durham Retractor, 16mm blade
- 16180-22** Durham Retractor, 22mm blade

**16190-24** Dyball And Lock Retractor, single ended, 240mm,  
63mm x 112mm blade

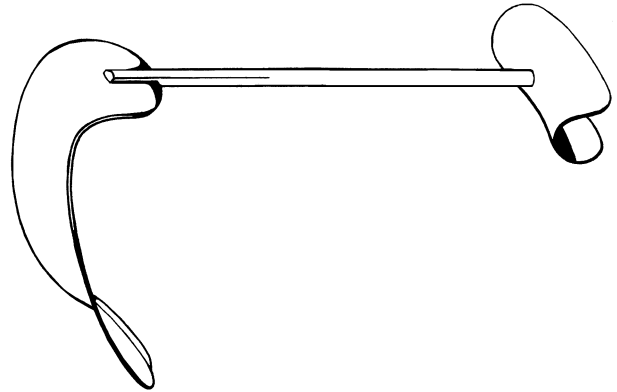

**16195-34** Dyson Retractor, 34mm wide

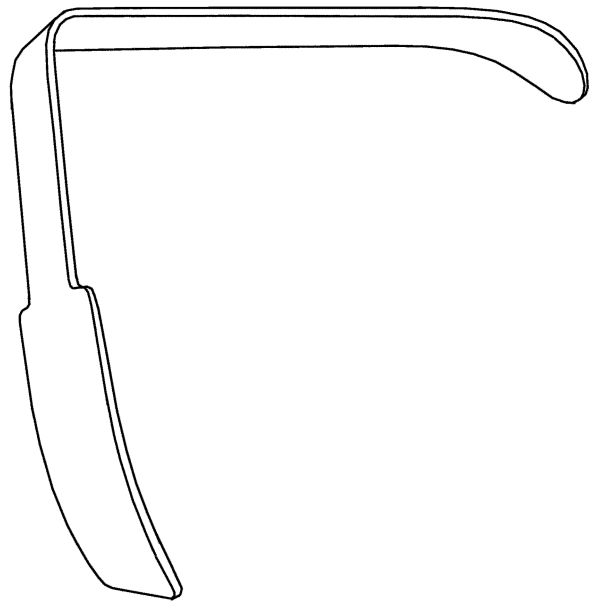

**16205-23** Jolls Thyroid Retractor, 30mm x 14mm, 230mm  
**16206-23** Jolls Thyroid Retractor, 40mm x 20mm, 230mm

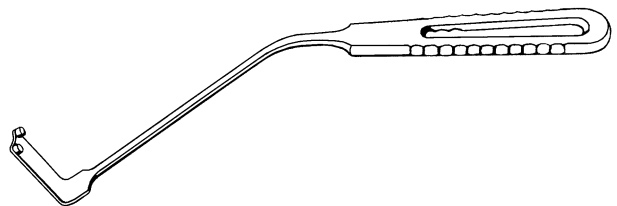

# General

## Retractors

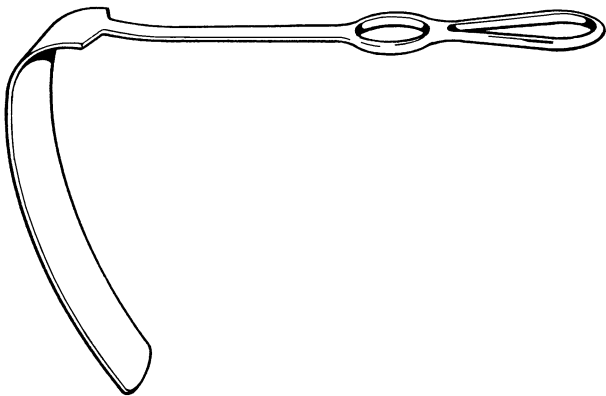

- 16210-38** Kelly Retractor, 270mm overall length, 190mm x 38mm blade
- 16210-57** Kelly Retractor, 270mm overall length, 190mm x 57mm blade

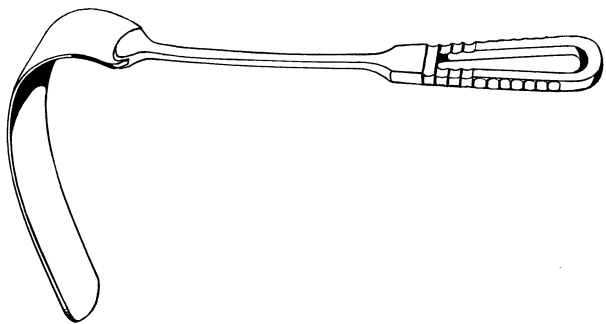

- 16211-38** Kelly Retractor, thackray pattern, 270mm overall length, 190mm x 38mm blade
- 16211-57** Kelly Retractor, thackray pattern, 270mm overall length, 190mm x 57mm blade

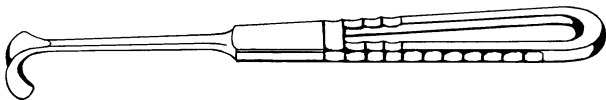

- 16220-11** Kocher Thyroid Retractor, shallow blade, 11mm wide

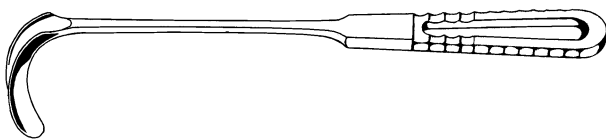

- 16220-14** Kocher Thyroid Retractor, deep blade, 14mm wide

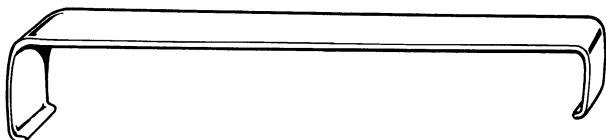

- 16230-13** Lane Retractor, double ended, 230mm, 13mm x 19mm blade
- 16230-25** Lane Retractor, double ended, 230mm, 25mm x 32mm blade



- 16240-06** Langenbeck Retractor, single ended, 22mm x 6mm blade
- 16240-08** Langenbeck Retractor, single ended, 25mm x 8mm blade
- 16240-11** Langenbeck Retractor, single ended, 35mm x 11mm blade
- 16240-13** Langenbeck Retractor, single ended, 45mm x 13mm blade
- 16240-15** Langenbeck Retractor, single ended, 35mm x 15mm blade
- 16240-20** Langenbeck Retractor, single ended, 90mm x 20mm blade
- 16240-25** Langenbeck Retractor, single ended, 65mm x 25mm blade

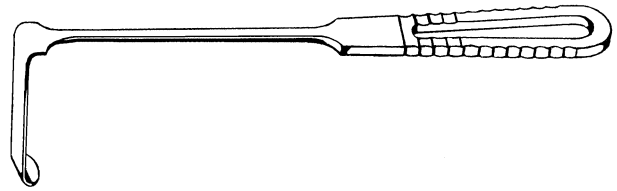

- 16250-30** Morris Retractor, double ended, 215mm, 30mm & 40mm wide x 50mm deep blades
- 16250-40** Morris Retractor, double ended, 215mm, 40mm & 65mm wide x 50mm deep blades
- 16250-45** Morris Retractor, double ended, 215mm, 45mm & 50mm wide x 50mm deep blades
- 16255-30** Morris Retractor, double ended, 215mm, 30mm & 40mm wide x 70mm deep blades
- 16255-45** Morris Retractor, double ended, 215mm, 45mm & 50mm wide x 70mm deep blades
- 16255-60** Morris Retractor, double ended, 215mm, 60mm & 65mm wide x 70mm deep blades

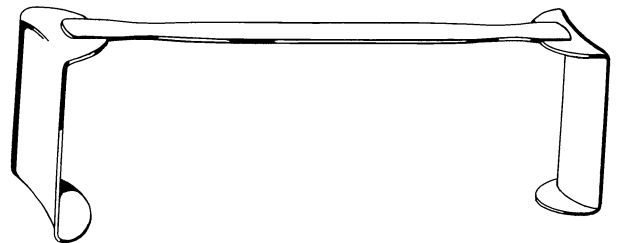

- 16260-40** Morris Retractor, single ended, 250mm, 40mm wide x 50mm deep blade
- 16260-50** Morris Retractor, single ended, 250mm, 50mm wide x 50mm deep blade
- 16260-65** Morris Retractor, single ended, 250mm, 65mm wide x 50mm deep blade
- 16270-40** Morris Retractor, single ended, 250mm, 40mm wide x 70mm deep blade
- 16270-50** Morris Retractor, single ended, 250mm, 50mm wide x 70mm deep blade
- 16270-65** Morris Retractor, single ended, 250mm, 65mm wide x 70mm deep blade

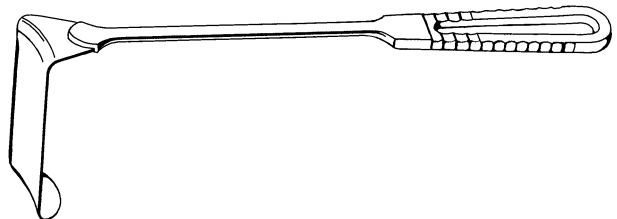

- 16271-30** Morris Toothed Retractor, single ended, 215mm, 30mm wide x 80mm deep blade

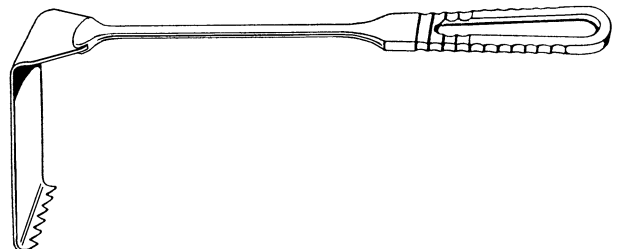

# General

## Retractors

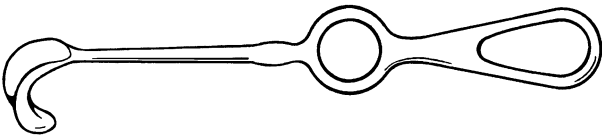

**16280-13** Moynihan Retractor, single ended, 215mm, 13mm x 22mm blade

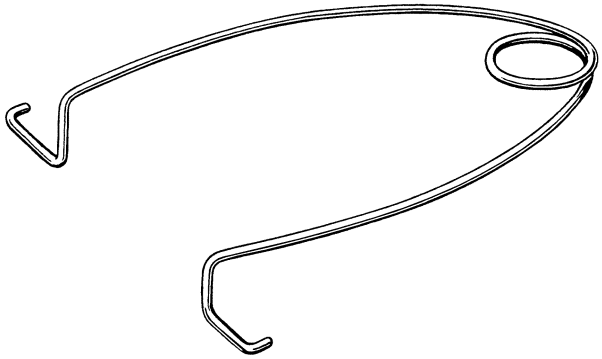

**16283-20** Ogilvie Retractor, 75mm expansion, 20mm wide x 20mm deep blades

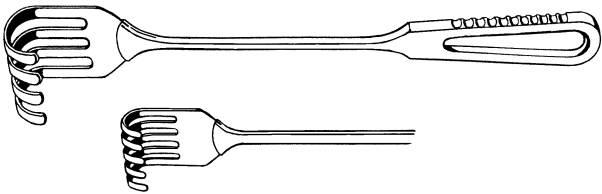

**16285-40** Oldfield Retractor, 4 prong, 270mm, broad blade, 50mm wide

**16285-50** Oldfield Retractor, 5 prong, 270mm, narrow blade, 40mm wide

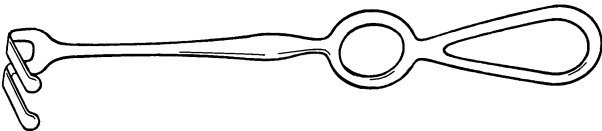

**16295-13** Ollier Retractor, single ended, 2 prong, 240mm, 13mm wide x 20mm deep blade

**16295-25** Ollier Retractor, single ended, 2 prong, 240mm, 25mm wide x 45mm deep blade

**16295-37** Ollier Retractor, single ended, 2 prong, 240mm, 37mm wide x 60mm deep blade

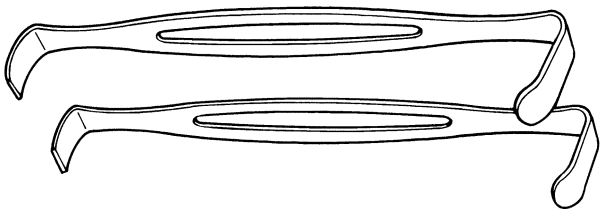

**16320-21** Parker-Langenbeck (U S Army) Retractor, set of 2, 210mm

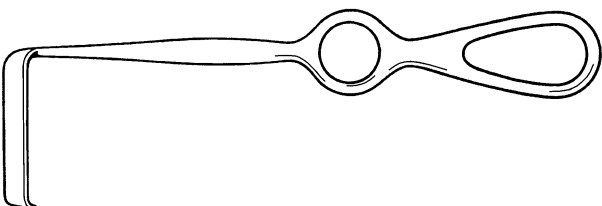

**16330-31** Paton Cartilage Retractor, 31mm x 10mm

**16330-44** Paton Cartilage Retractor, 44mm x 10mm

**16330-51** Paton Cartilage Retractor, 51mm x 14mm

16332-65 Proust Retractor, 65mm x 45mm

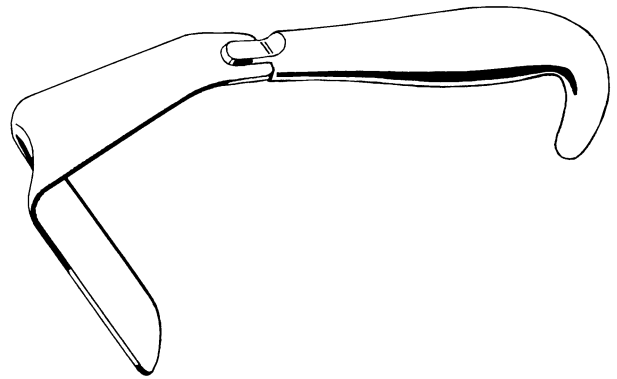

- 16334-10 Pyrah Retractor, 75mm x 50mm
- 16334-20 Pyrah Retractor, 100mm x 50mm
- 16334-30 Pyrah Retractor, 100mm x 65mm
- 16334-40 Pyrah Retractor, 125mm x 70mm
- 16334-50 Pyrah Retractor, 150mm x 80mm

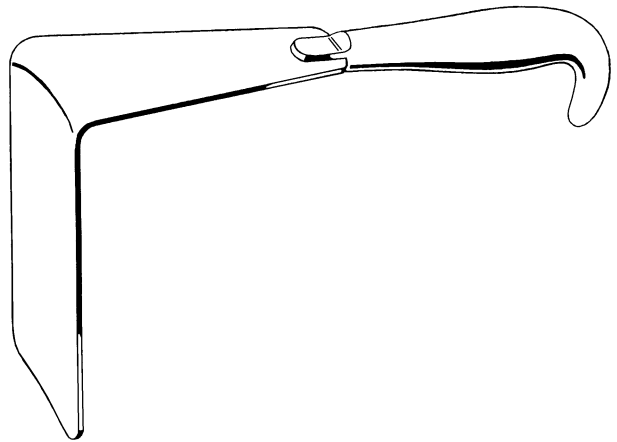

- 16336-03 Shucksmith Retractor, 30mm x 13mm
- 16336-05 Shucksmith Retractor, 50mm x 13mm
- 16336-06 Shucksmith Retractor, 65mm x 30mm
- 16336-08 Shucksmith Retractor, 80mm x 30mm
- 16336-09 Shucksmith Retractor, 95mm x 45mm
- 16336-11 Shucksmith Retractor, 115mm x 50mm
- 16336-12 Shucksmith Retractor, 125mm x 55mm
- 16336-14 Shucksmith Retractor, 140mm x 60mm
- 16336-15 Shucksmith Retractor, 155mm x 70mm
- 16336-17 Shucksmith Retractor, 170mm x 80mm
- 16336-90 Shucksmith Retractor, set of 10 complete with storage clamp

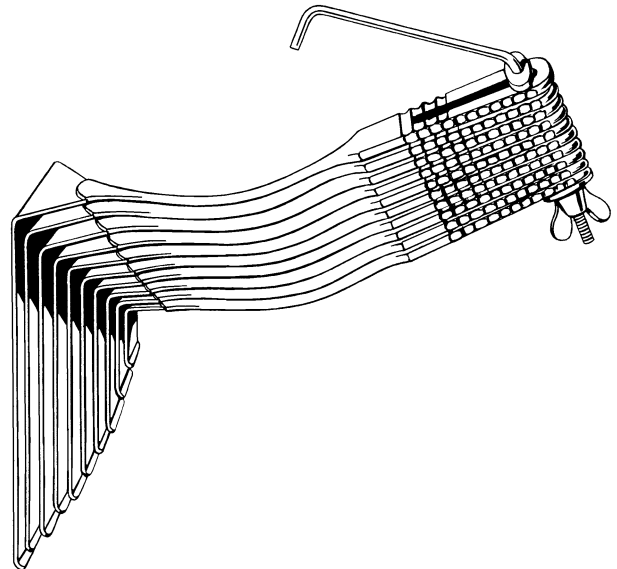

# General

## Retractors

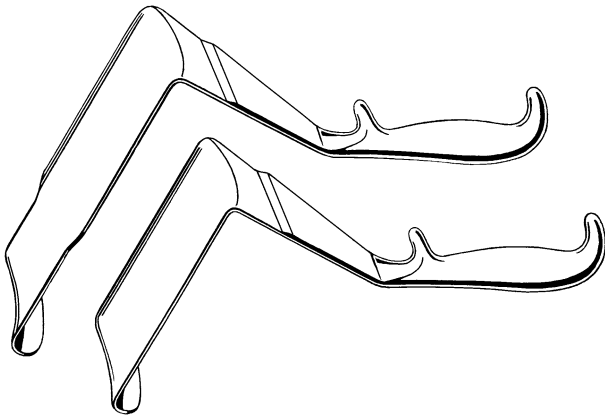

- 16340-12** St.Marks Hospital Retractor, with lip, 125mm x 60mm blade
- 16340-17** St.Marks Hospital Retractor, with lip, 175mm x 60mm blade
- 16342-12** St.Marks Hospital Retractor, with lip, 125mm x 60mm blade, with twin fibrelight
- 16342-17** St.Marks Hospital Retractor, with lip, 175mm x 60mm blade, with twin fibrelight

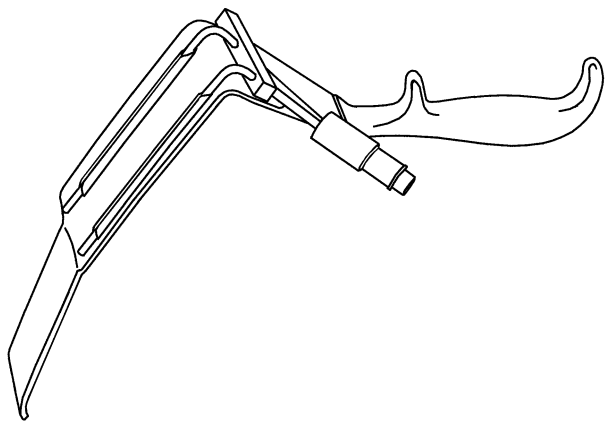

- 16340-20** St.Marks Hospital Retractor, with lip, 205mm x 60mm blade, cranked
- 16342-20** St.Marks Hospital Retractor, with lip, 205mm x 60mm blade, cranked, with twin fibrelight
- 16345-20** St.Marks Hospital Retractor, twin fibrelight stem only

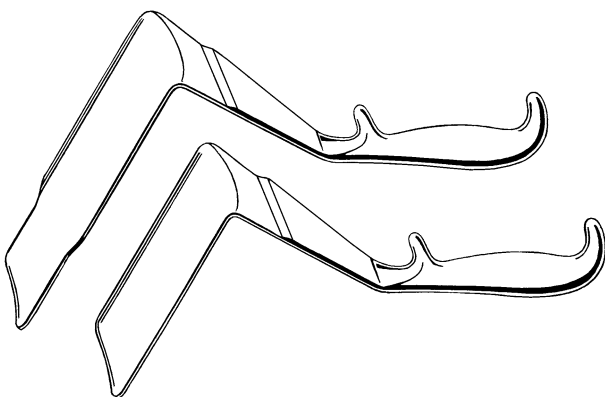

- 16350-12** St.Marks Hospital Retractor, without lip, 125mm x 60mm blade
- 16350-17** St.Marks Hospital Retractor, without lip, 175mm x 60mm blade
- 16352-12** St.Marks Hospital Retractor, without lip, 125mm x 60mm blade, with twin fibrelight
- 16352-17** St.Marks Hospital Retractor, without lip, 175mm x 60mm blade, with twin fibrelight

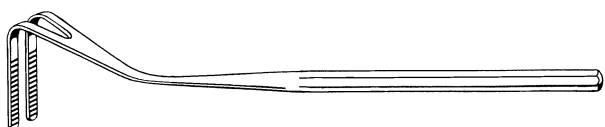

- 16358-13** Stack Retractor, 13mm deep blades, 140mm
- 16358-25** Stack Retractor, 25mm deep blades, 140mm

**Retractors**

- 16360-18** Tracheal Hook Retractor, double, blunt, 180mm
- 16370-18** Tracheal Hook Retractor, double, sharp, 180mm



- 16380-18** Tracheal Hook Retractor, single, blunt, 150mm
- 16390-18** Tracheal Hook Retractor, single, sharp, 150mm

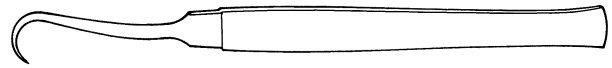

- 16400-10** Volkmann Retractor, blunt, 220mm, 1 prong
- 16400-20** Volkmann Retractor, blunt, 220mm, 2 prong
- 16400-30** Volkmann Retractor, blunt, 220mm, 3 prong
- 16400-40** Volkmann Retractor, blunt, 220mm, 4 prong
- 16400-50** Volkmann Retractor, blunt, 220mm, 5 prong
- 16400-60** Volkmann Retractor, blunt, 220mm, 6 prong
- 16410-10** Volkmann Retractor, semi-sharp, 220mm, 1 prong
- 16410-20** Volkmann Retractor, semi-sharp, 220mm, 2 prong
- 16410-30** Volkmann Retractor, semi-sharp, 220mm, 3 prong
- 16410-40** Volkmann Retractor, semi-sharp, 220mm, 4 prong
- 16410-50** Volkmann Retractor, semi-sharp, 220mm, 5 prong
- 16410-60** Volkmann Retractor, semi-sharp, 220mm, 6 prong
- 16420-10** Volkmann Retractor, sharp, 220mm, 1 prong
- 16420-20** Volkmann Retractor, sharp, 220mm, 2 prong
- 16420-30** Volkmann Retractor, sharp, 220mm, 3 prong
- 16420-40** Volkmann Retractor, sharp, 220mm, 4 prong
- 16420-50** Volkmann Retractor, sharp, 220mm, 5 prong
- 16420-60** Volkmann Retractor, sharp, 220mm, 6 prong

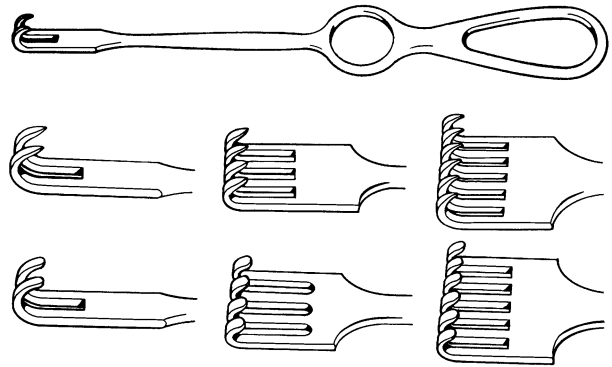

# General

## Retractors

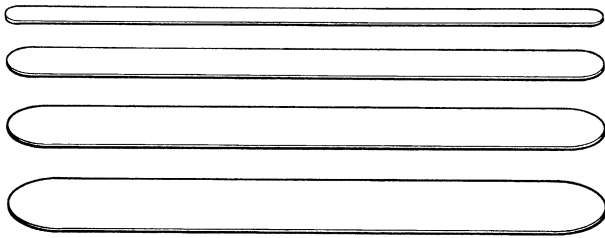

<b>16430-06</b>	Walton Retractor, copper, malleable, 180mm x 6mm
<b>16430-08</b>	Walton Retractor, copper, malleable, 180mm x 8mm
<b>16430-11</b>	Walton Retractor, copper, malleable, 180mm x 11mm
<b>16430-12</b>	Walton Retractor, copper, malleable, 180mm x 12mm
<b>16430-13</b>	Walton Retractor, copper, malleable, 180mm x 13mm
<b>16430-16</b>	Walton Retractor, copper, malleable, 180mm x 16mm
<b>16430-19</b>	Walton Retractor, copper, malleable, 180mm x 19mm
<b>16430-25</b>	Walton Retractor, copper, malleable, 180mm x 25mm
<b>16430-32</b>	Walton Retractor, copper, malleable, 180mm x 32mm
<b>16430-38</b>	Walton Retractor, copper, malleable, 180mm x 38mm
<b>16430-50</b>	Walton Retractor, copper, malleable, 180mm x 50mm
<b>16430-63</b>	Walton Retractor, copper, malleable, 180mm x 63mm
<b>16435-08</b>	Walton Retractor, copper, malleable, 200mm x 8mm
<b>16435-13</b>	Walton Retractor, copper, malleable, 200mm x 13mm
<b>16435-16</b>	Walton Retractor, copper, malleable, 200mm x 16mm
<b>16435-19</b>	Walton Retractor, copper, malleable, 200mm x 19mm
<b>16435-25</b>	Walton Retractor, copper, malleable, 200mm x 25mm
<b>16440-13</b>	Walton Retractor, copper, malleable, 255mm x 13mm
<b>16440-19</b>	Walton Retractor, copper, malleable, 255mm x 19mm
<b>16440-25</b>	Walton Retractor, copper, malleable, 255mm x 25mm
<b>16440-32</b>	Walton Retractor, copper, malleable, 255mm x 32mm
<b>16440-38</b>	Walton Retractor, copper, malleable, 255mm x 38mm
<b>16440-50</b>	Walton Retractor, copper, malleable, 255mm x 50mm
<b>16440-63</b>	Walton Retractor, copper, malleable, 255mm x 63mm
<b>16450-13</b>	Walton Retractor, copper, malleable, 300mm x 13mm
<b>16450-19</b>	Walton Retractor, copper, malleable, 300mm x 19mm
<b>16450-25</b>	Walton Retractor, copper, malleable, 300mm x 25mm
<b>16450-32</b>	Walton Retractor, copper, malleable, 300mm x 32mm
<b>16450-38</b>	Walton Retractor, copper, malleable, 300mm x 38mm
<b>16450-45</b>	Walton Retractor, copper, malleable, 300mm x 45mm
<b>16450-50</b>	Walton Retractor, copper, malleable, 300mm x 50mm
<b>16450-63</b>	Walton Retractor, copper, malleable, 300mm x 63mm

**Retractors**

**16460-50** Walton Retractor, tapered, copper, malleable.  
300mm x 50mm tapering to 25mm

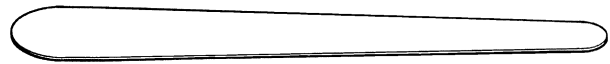

**Retractors - Self Retaining**

**16500-09** Balfour Self Retaining Retractor, fenestrated end blades, baby, 90mm

**16500-10** Balfour Self Retaining Retractor, fenestrated end blades, child, 100mm

**16500-18** Balfour Self Retaining Retractor, fenestrated end blades, adult, 180mm

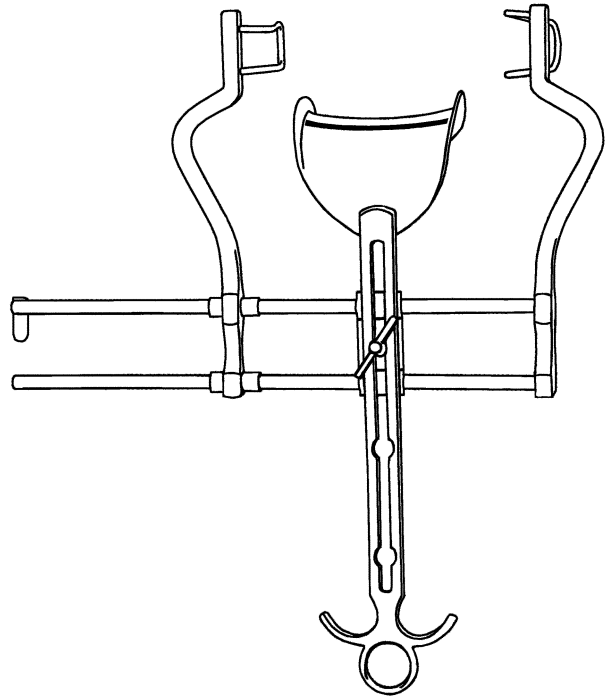

**16505-19** Balfour Self Retaining Retractor, with trigger ratchet, 2 pairs detachable end blades 45mm wide x 65mm & 85mm deep, centre blade 65mm x 65mm, 195mm

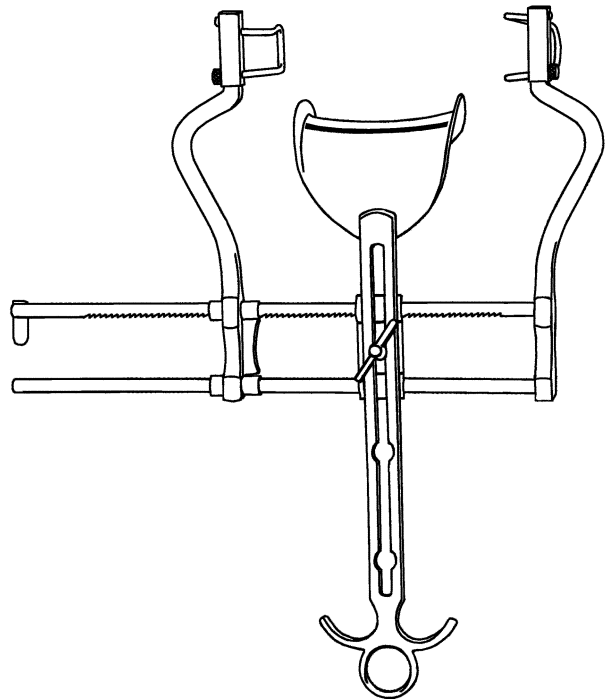

## General

### Retractors - Self Retaining

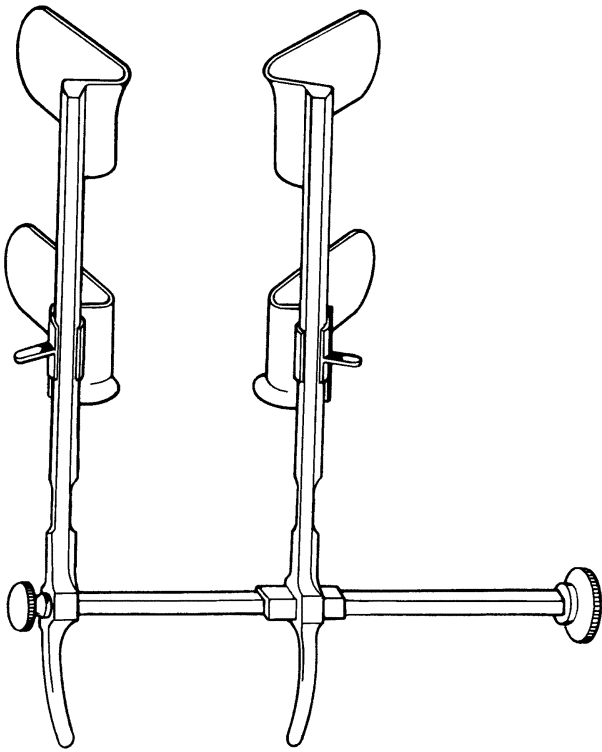

**16510-60** Berkeley Abdominal Self Retaining Retractor, parallel action, 35mm, 60mm blades

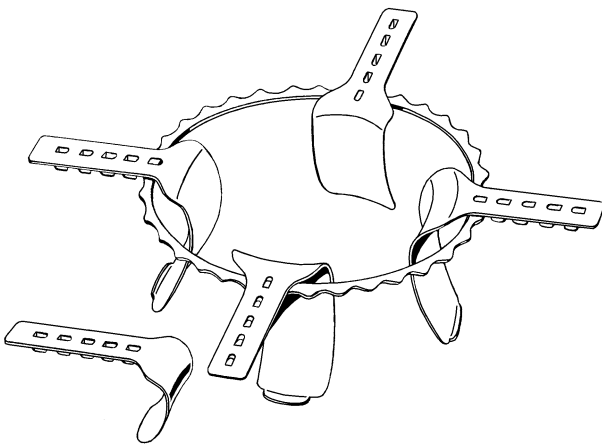

**16520-10** Cleland Self Retaining Retractor, deep angled blade only, 115mm x 65mm

**16520-20** Cleland Self Retaining Retractor, frame only, 250mm ID

**16520-30** Cleland Self Retaining Retractor, shallow curved blade only, 50mm x 40mm

**16520-90** Cleland Self Retaining Retractor, complete set, 1 x frame, 4 x shallow curved blades, 4 x deep angled blades



Retractors - Self Retaining

- 16530-90 Collin Self Retaining Retractor, complete with centre blade, 38mm, 60mm blades
- 16540-90 Collin Self Retaining Retractor, without centre blade, 38mm, 60mm blades

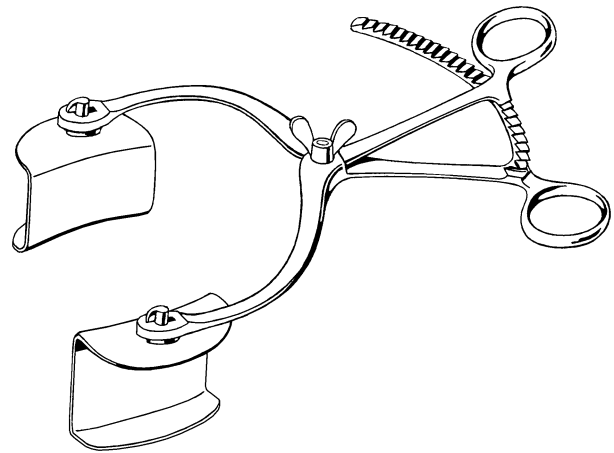

- 16545-85 DeBakey-Balfour Self Retaining Retractor, with trigger ratchet, blades 45mm wide x 85mm deep, centre blade 85mm wide x 70mm deep

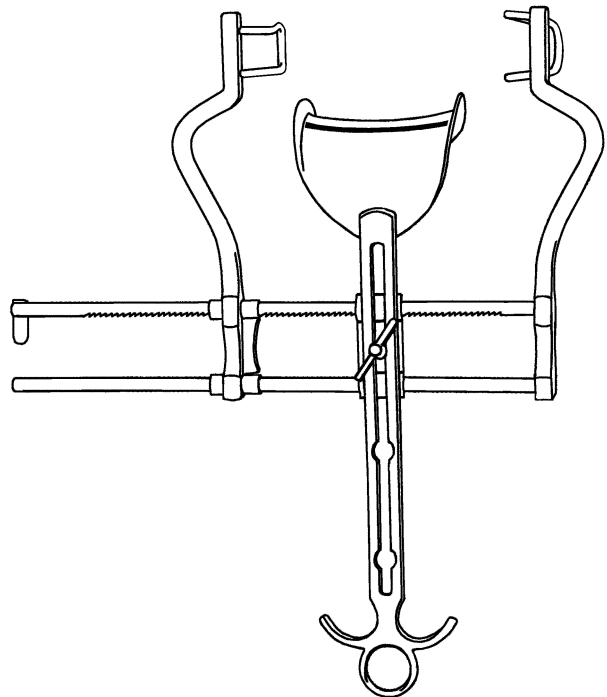

- 16550-50 Denis Browne Self Retaining Retractor, oval frame only, 180mm x 140mm
- 16550-90 Denis Browne Self Retaining Retractor, set, 1 x frame, 4 x blades A B C, 2 x blade D, 1 x blades E F G H J

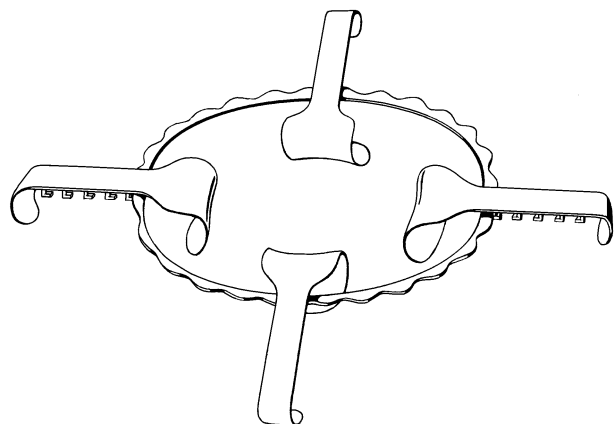

# General

## Retractors - Self Retaining

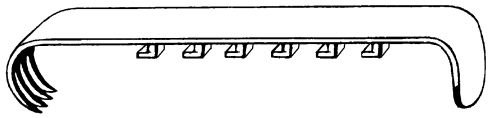

**16550-05** Denis Browne Self Retaining Retractor, blade 'A' only, curved claw blade, 13mm x 13mm

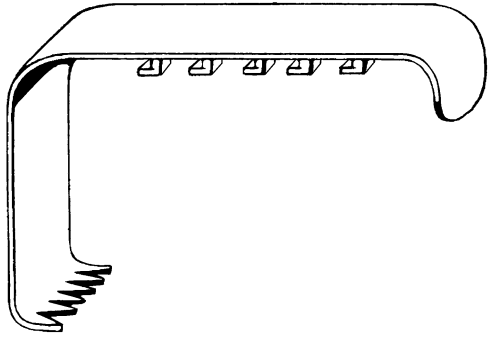

**16550-10** Denis Browne Self Retaining Retractor, blade 'B' only, angled claw blade, 60mm x 20mm

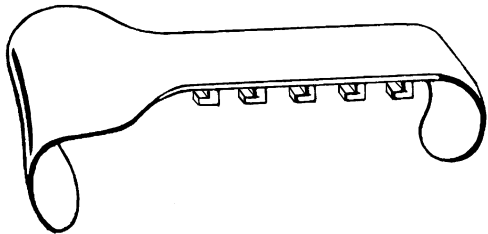

**16550-15** Denis Browne Self Retaining Retractor, blade 'C' only, curved blade, 40mm x 35mm

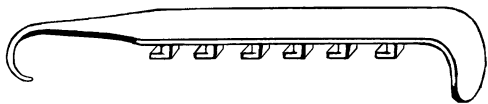

**16550-20** Denis Browne Self Retaining Retractor, blade 'D' only, curved hook blade, sharp

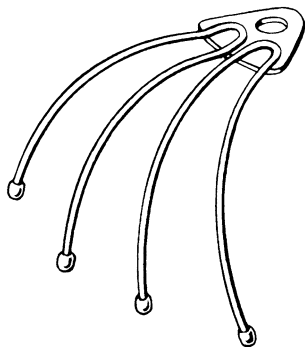

**16550-25** Denis Browne Self Retaining Retractor, blade 'E' only, lung retractor end to fit shaft 'H'

**Retractors - Self Retaining**

**16550-30** Denis Browne Self Retaining Retractor, blade 'F' only, curved blade end to fit shaft 'H'

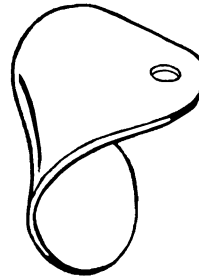

**16550-35** Denis Browne Self Retaining Retractor, blade 'G' only, regressive curved blade end to fit shaft 'H'

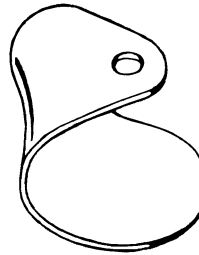

**16550-40** Denis Browne Self Retaining Retractor, shaft 'H' only, with threaded retaining action

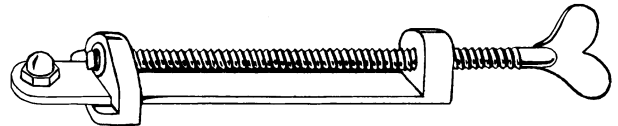

**16550-45** Denis Browne Self Retaining Retractor, spanner 'J' only, to fit shaft 'H'

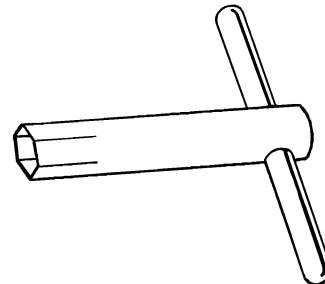

# General

## Retractors - Self Retaining

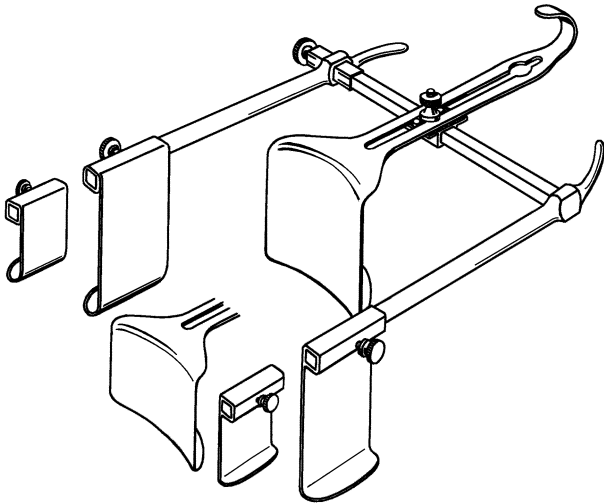

- 16560-10** Goligher Self Retaining Retractor, wing nut only
- 16560-20** Goligher Self Retaining Retractor, knurled end nut only
- 16560-50** Goligher Self Retaining Retractor, deep lateral blade only, 50mm wide x 90mm deep
- 16560-55** Goligher Self Retaining Retractor, shallow lateral blade only, 50mm
- 16560-60** Goligher Self Retaining Retractor, deep centre blade only, 90mm wide x 90mm deep
- 16560-65** Goligher Self Retaining Retractor, shallow centre blade only, 90mm wide x 55mm deep
- 16560-70** Goligher Self Retaining Retractor, wingnut and mount for centre blade only
- 16560-80** Goligher Self Retaining Retractor, frame only
- 16560-90** Goligher Self Retaining Retractor, complete with 2 centre blades, 2 pairs lateral blades

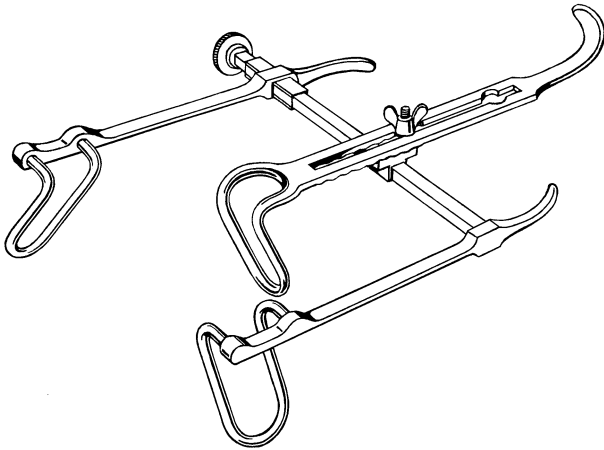

- 16570-90** Gossett Panting Self Retaining Retractor, large, complete with centre blade
- 16580-90** Gossett Panting Self Retaining Retractor, small, complete with centre blade

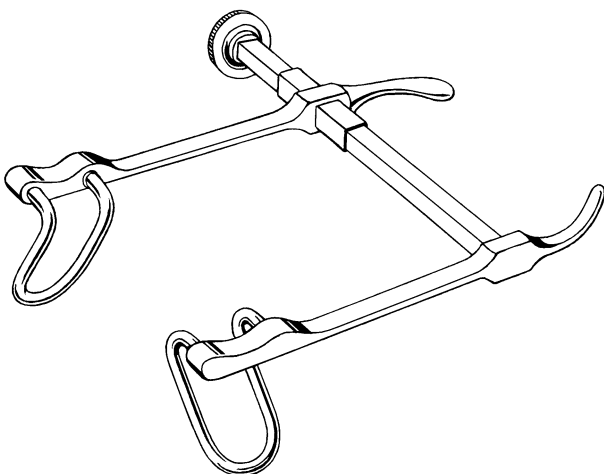

- 16590-90** Gossett Self Retaining Retractor, large
- 16600-90** Gossett Self Retaining Retractor, small

Retractors - Self Retaining

16605-18 Irwin Self Retaining Retractor, cam rack, 4/4 teeth, 180mm

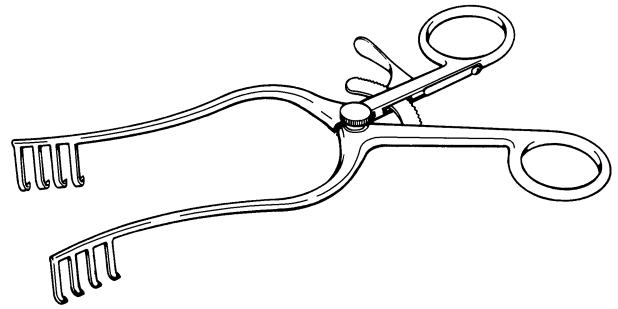

16610-15 Jolls Thyroid Self Retaining Retractor, 150mm

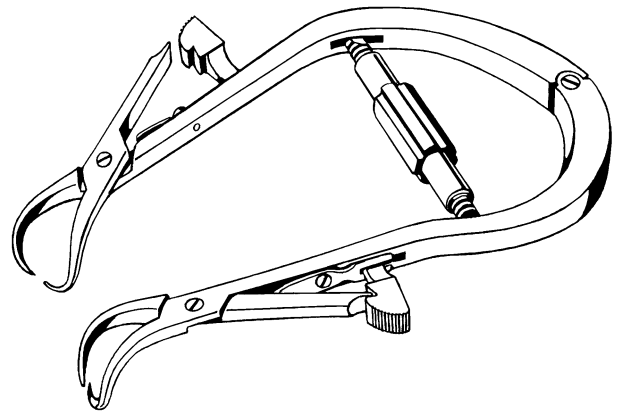

16620-90 Lace Self Retaining Retractor, with 1 pair side blades

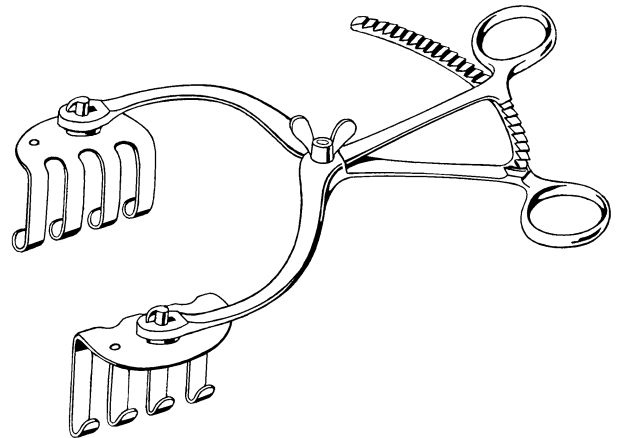

16625-90 McKeown Self Retaining Retractor, 60mm deep x 45mm wide blades

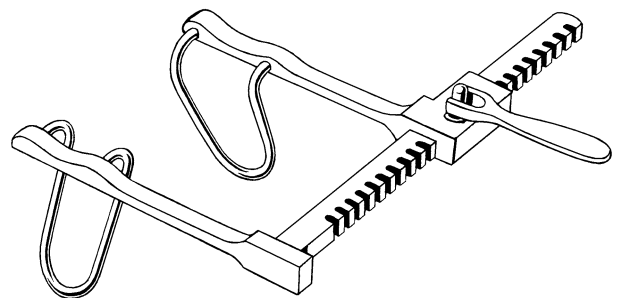

# General

## Retractors - Self Retaining

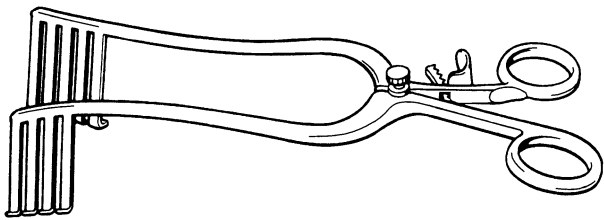

**16630-21** Norfolk And Norwich Self Retaining Retractor, cam rack, 4/5 teeth, 215mm, 50mm blades

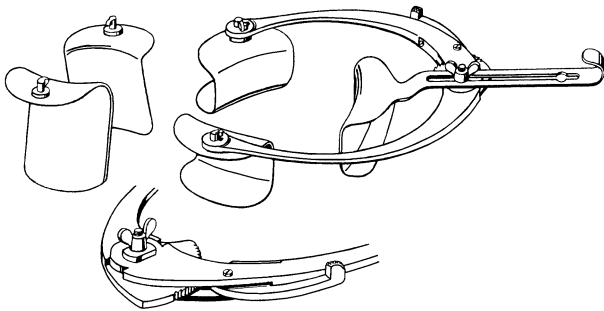

**16640-20** Ricard Begouin Self Retaining Retractor, 200mm spread, 35mm deep x 65mm wide and 65mm deep x 65mm wide blades

**16645-28** Ricard Begouin Griffiths Self Retaining Retractor, 280mm spread, 60mm deep x 80mm wide and 100mm deep x 80mm wide blades

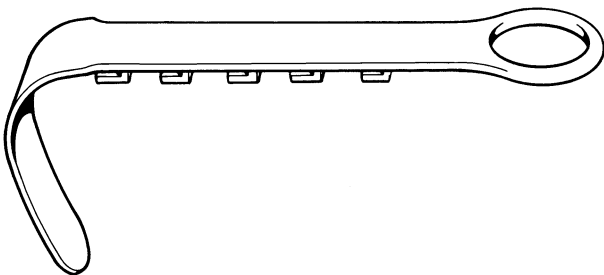

**16650-05** Swift Joly Self Retaining Retractor, blade 'A' only, 50mm deep x 25mm wide

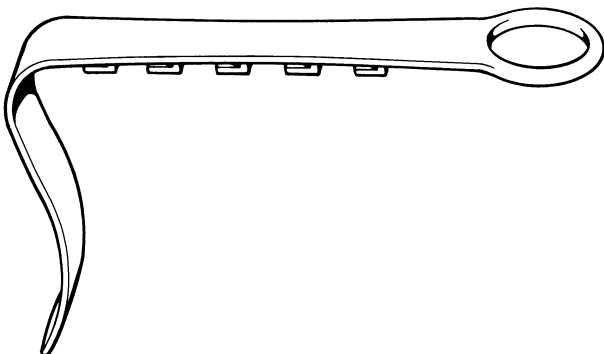

**16650-10** Swift Joly Self Retaining Retractor, blade 'B' only, 70mm deep x 25mm wide

**Retractors - Self Retaining**

**16650-15** Swift Joly Self Retaining Retractor, blade 'C' only,  
90mm deep x 25mm wide

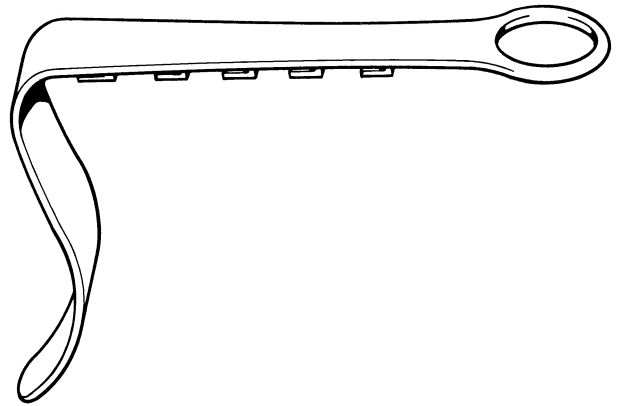

**16650-20** Swift Joly Self Retaining Retractor, blade 'D' only,  
65mm deep x 65mm wide

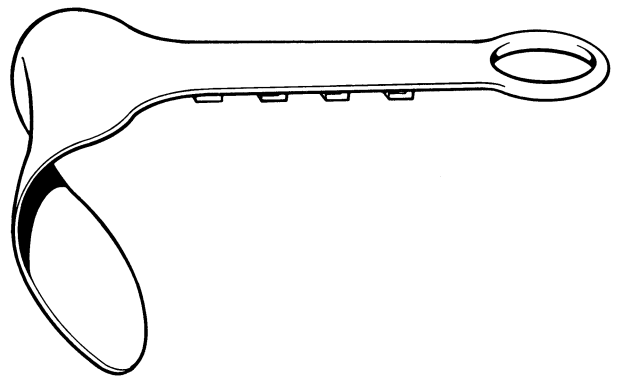

**16650-50** Swift Joly Self Retaining Retractor, oval frame  
only, 180mm x 140mm

**16650-90** Swift Joly Self Retaining Retractor, complete, 1 x  
frame, 1 x blades A B, 2 x blades C D

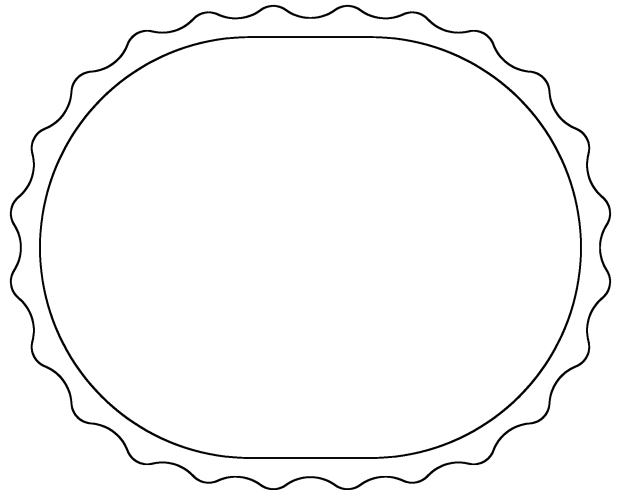

# General

## Retractors - Self Retaining

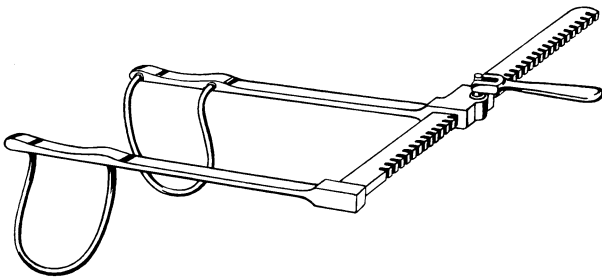

**16655-90** Stevens Abdominal Self Retaining Retractor, lightweight, 60mm deep x 45mm wide blades, 190g (7oz)

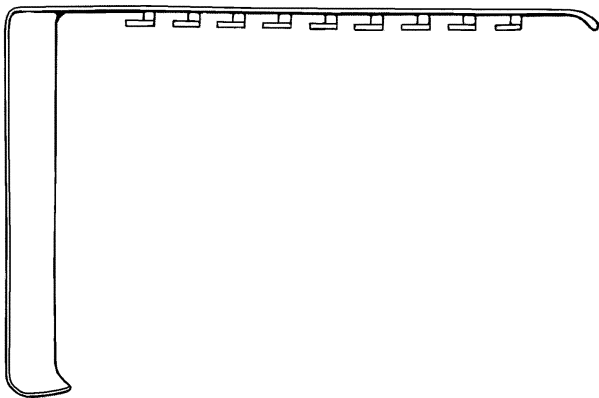

**16658-05** St. Thomas Hospital Self Retaining Retractor, blade 'A' only, right angled, 230mm long with 9 pegs, 145mm deep x 50mm wide

**16658-10** St. Thomas Hospital Self Retaining Retractor, blade 'B' only, right angled, 215mm long with 9 pegs, 125mm deep x 38mm wide

**16658-15** St. Thomas Hospital Self Retaining Retractor, blade 'C' only, right angled, 180mm long with 6 pegs, 120mm deep x 38mm wide

**16658-20** St. Thomas Hospital Self Retaining Retractor, blade 'D' only, right angled, 180mm long with 6 pegs, 95mm deep x 38mm wide

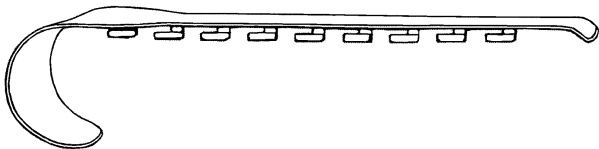

**16658-25** St. Thomas Hospital Self Retaining Retractor, blade 'E' only, curved, 215mm long with 9 pegs, 45mm deep x 38mm wide

**16658-30** St. Thomas Hospital Self Retaining Retractor, blade 'F' only, curved, 180mm long with 7 pegs, 45mm deep x 38mm wide

**16658-35** St. Thomas Hospital Self Retaining Retractor, blade 'G' only, curved, 125mm long with 4 pegs, 45mm deep x 38mm wide

**16658-50** St. Thomas Hospital Self Retaining Retractor, blade 'K' only, curved, 215mm long with 9 pegs, 65mm deep x 38mm wide

**16658-52** St. Thomas Hospital Self Retaining Retractor, blade 'L' only, curved, 180mm long with 7 pegs, 65mm deep x 38mm wide

**16658-54** St. Thomas Hospital Self Retaining Retractor, blade 'M' only, curved, 125mm long with 4 pegs, 65mm deep x 38mm wide

**16658-56** St. Thomas Hospital Self Retaining Retractor, blade 'N' only, curved, 215mm long with 9 pegs, 85mm deep x 38mm wide



**Retractors - Self Retaining**

- 16658-40** St.Thomas Hospital Self Retaining Retractor, blade 'H' only, deaver type, guttered, 230mm long with 6 pegs, 115mm deep x 70mm tapering to 64mm
- 16658-45** St.Thomas Hospital Self Retaining Retractor, blade 'J' only, deaver type, guttered, 255mm long with 6 pegs, 150mm deep x 70mm tapering to 64mm

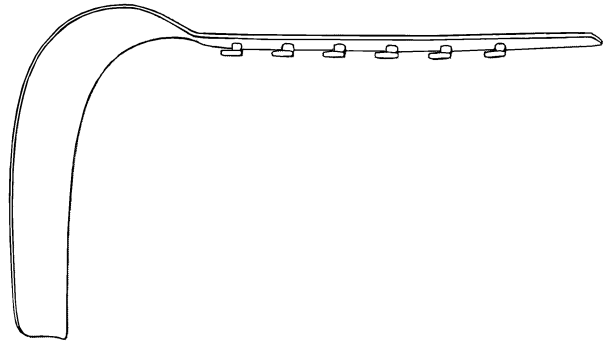

- 16658-60** St.Thomas Hospital Self Retaining Retractor, frame 'A' only, 255mm x 345mm
- 16658-70** St.Thomas Hospital Self Retaining Retractor, frame 'B' only, 330mm x 445mm
- 16658-90** St.Thomas Hospital Self Retaining Retractor, complete, 1 x frame A, 1 x blades A B C D E F G H J

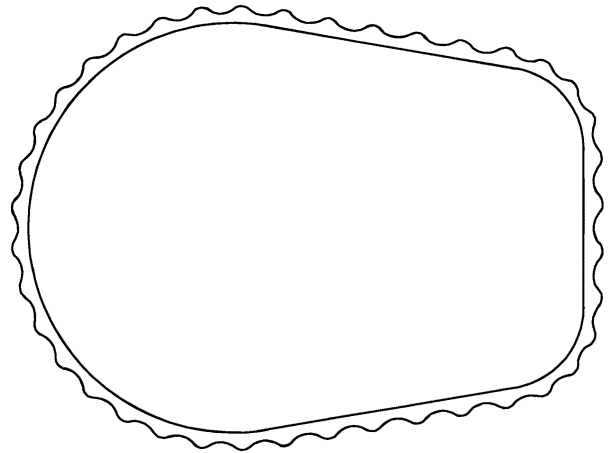

- 16660-20** Travers Self Retaining Retractor, 200mm

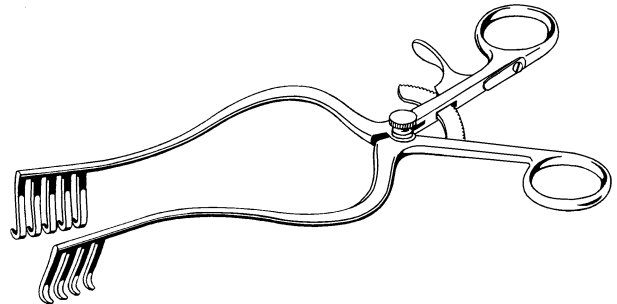

- 16670-05** Turner Warwick Universal Self Retaining Retractor, blade 'A' only, copper blade, 19mm x 76mm

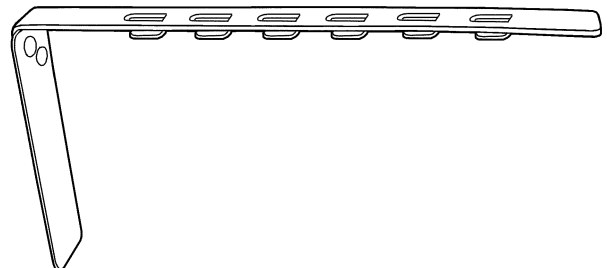

# General

## Retractors - Self Retaining

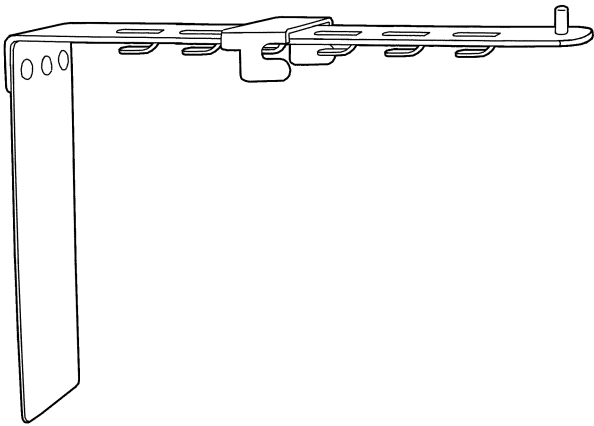

**16670-10** Turner Warwick Universal Self Retaining Retractor, blade 'B' only, copper blade, with clip, 38mm x 102mm

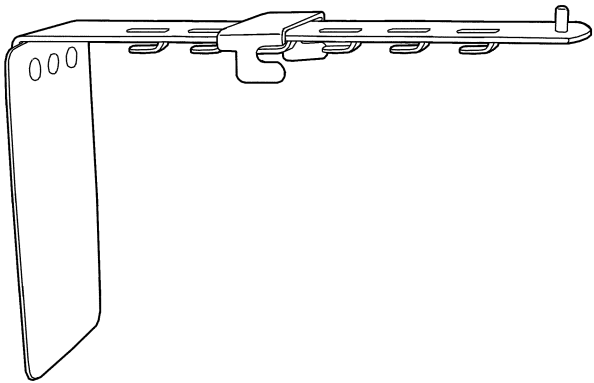

**16670-15** Turner Warwick Universal Self Retaining Retractor, blade 'C' only, copper blade, with clip, 57mm x 89mm

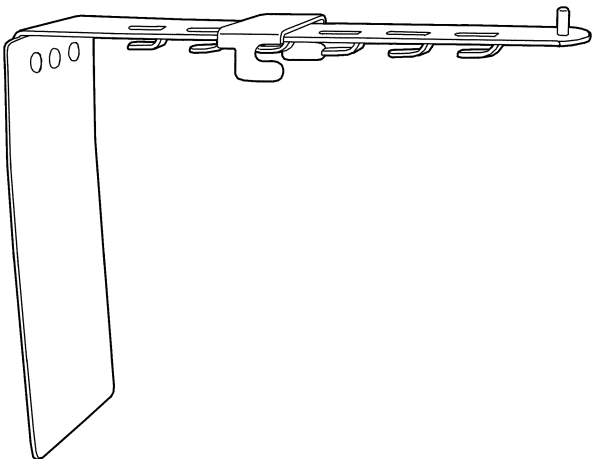

**16670-20** Turner Warwick Universal Self Retaining Retractor, blade 'D' only, copper blade, with clip, 57mm x 114mm

**Retractors - Self Retaining**

**16670-25** Turner Warwick Universal Self Retaining Retractor, blade 'E' only, curved, 51mm dia. x 38mm

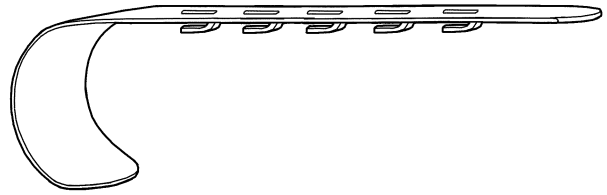

**16670-30** Turner Warwick Universal Self Retaining Retractor, blade 'F' only, curved, with clip, 76mm dia. x 60mm

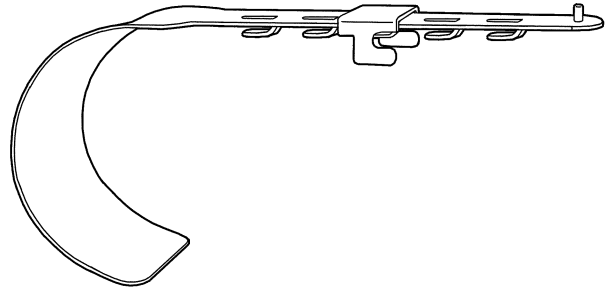

**16670-35** Turner Warwick Universal Self Retaining Retractor, blade 'G' only, flat, with clip, 89mm x 60mm

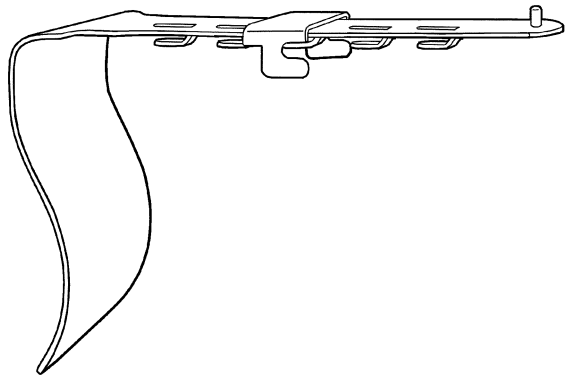

**16670-40** Turner Warwick Universal Self Retaining Retractor, blade 'H' only, flat, with clip, 114mm x 60mm

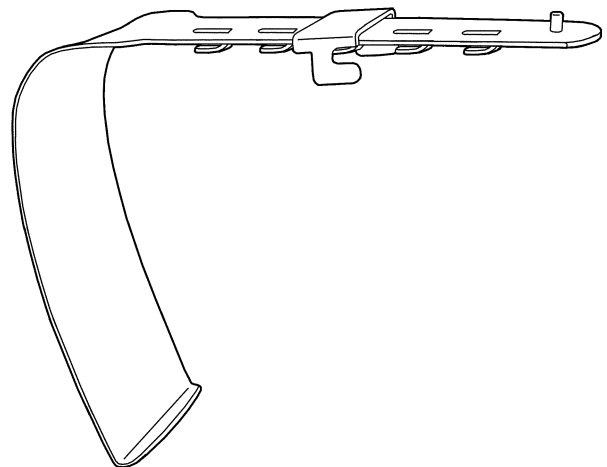

# General

## Retractors - Self Retaining

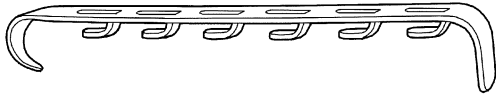

**16670-45** Turner Warwick Universal Self Retaining Retractor, blade 'J' only, single hook, 13mm deep

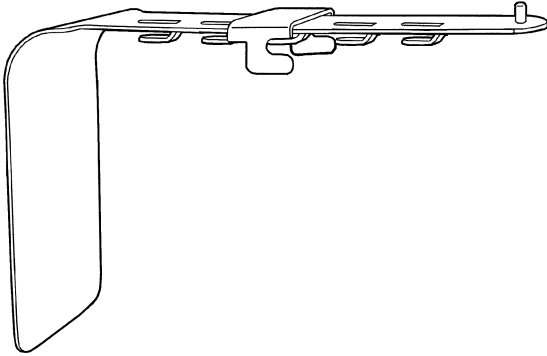

**16670-50** Turner Warwick Universal Self Retaining Retractor, blade 'K' only, flat, with clip, 55mm x 90mm

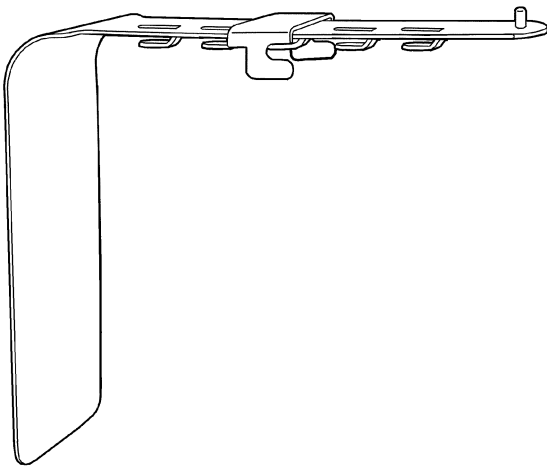

**16670-52** Turner Warwick Universal Self Retaining Retractor, blade 'L' only, flat, with clip, 55mm x 120mm

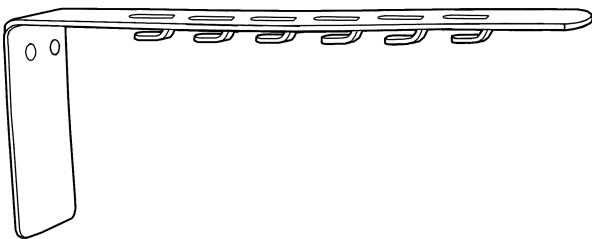

**16670-54** Turner Warwick Universal Self Retaining Retractor, blade 'M' only, copper blade, 31mm x 55mm

Retractors - Self Retaining

**16670-56** Turner Warwick Universal Self Retaining Retractor, blade 'N' only, deep curved, 60mm x 55mm

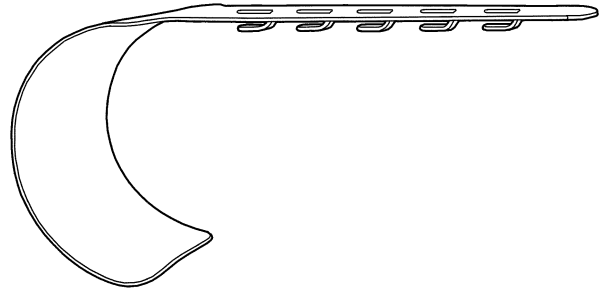

**16670-58** Turner Warwick Universal Self Retaining Retractor, blade 'P' only, shallow curved, 28mm x 30mm

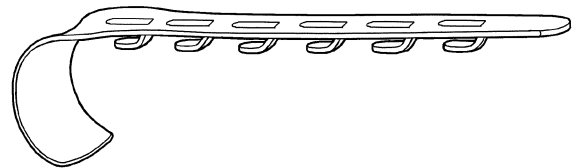

**16670-60** Turner Warwick Universal Self Retaining Retractor, circular frame 'A' only, 178mm ID

**16670-65** Turner Warwick Universal Self Retaining Retractor, circular frame 'B' only, 229mm ID

**16670-70** Turner Warwick Universal Self Retaining Retractor, circular frame 'C' only, 305mm ID

**16670-75** Turner Warwick Universal Self Retaining Retractor, oval frame 'D' only, 457mm x 330mm ID

**16670-80** Turner Warwick Universal Self Retaining Retractor, oval frame 'E' only, 370mm x 300mm ID

**16670-90** Turner Warwick Universal Self Retaining Retractor, complete, 1 x frames A B C D, 2 x blades A B C D E F G H J

**16670-95** Turner Warwick Universal Self Retaining Retractor, complete, 1 x frames B C, 4 x blade E, 2 x blade N, 1 x blades C K L

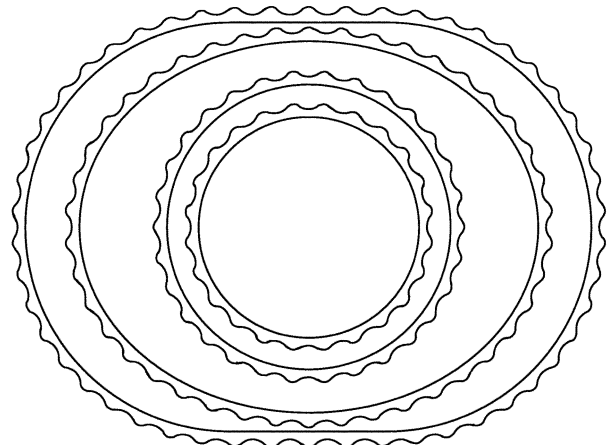

**16680-14** Weislander Self Retaining Retractor, 3/4 teeth, blunt, 140mm

**16690-14** Weislander Self Retaining Retractor, 3/4 teeth, sharp, 140mm

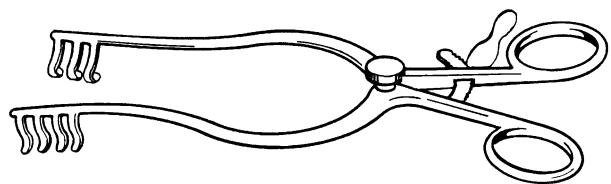

# General

## Retractors - Self Retaining

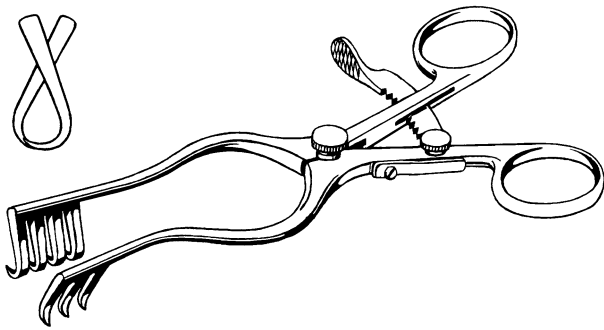

16700-14 West Self Retaining Retractor, sharp, 140mm

## Saws

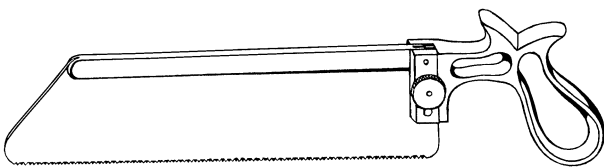

16900-20 Amputation Saw, 200mm

16900-22 Amputation Saw, 225mm

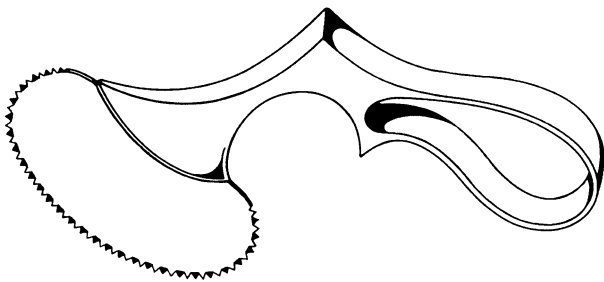

16920-10 Engels Plaster Saw

## Scalpel Handles

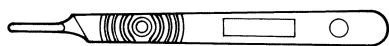

17020-30 Scalpel Handle, No.3

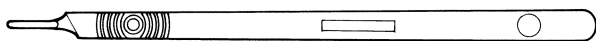

17020-35 Scalpel Handle, No.3L

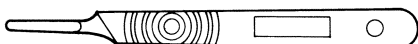

17020-40 Scalpel Handle, No.4

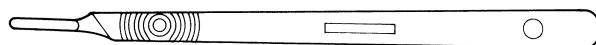

17020-45 Scalpel Handle, No.4L

Scalpel Handles

17020-70 Scalpel Handle, No.7

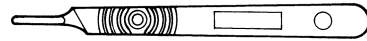

Scissors

17100-15 Aufricht Dissecting Scissor, curved, light pattern, 150mm

17120-15 Aufricht Dissecting Scissor, straight, light pattern, 150mm



17110-14 Aufricht Dissecting Scissor, curved, triangular blade, 140mm

17130-14 Aufricht Dissecting Scissor, straight, triangular blade, 140mm

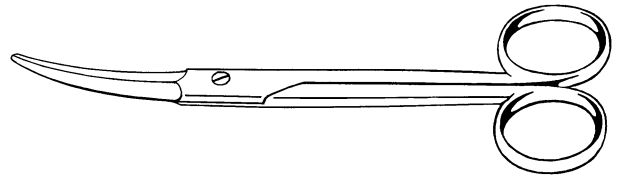

17140-16 Carless Scissor, straight, lightweight, blunt point, 165mm

17140-20 Carless Scissor, straight, lightweight, blunt point, 200mm

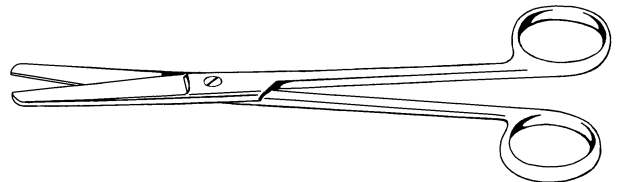

17160-18 Doyen Scissor, straight, blunt point, 180mm

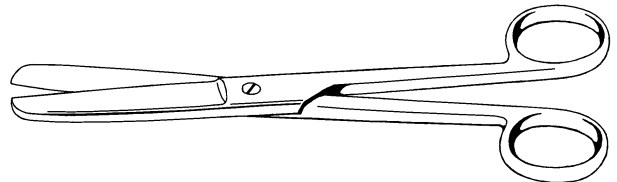

17170-10 Dressing Scissor, curved, blunt / blunt, 100mm

17170-12 Dressing Scissor, curved, blunt / blunt, 125mm

17170-14 Dressing Scissor, curved, blunt / blunt, 140mm

17170-15 Dressing Scissor, curved, blunt / blunt, 150mm

17170-18 Dressing Scissor, curved, blunt / blunt, 180mm

17170-20 Dressing Scissor, curved, blunt / blunt, 200mm

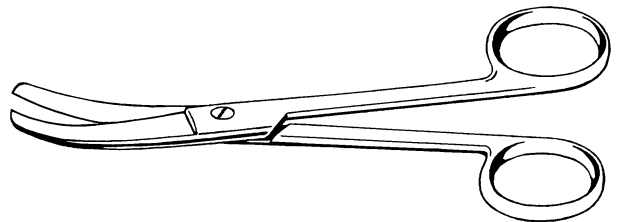

# General

## Scissors

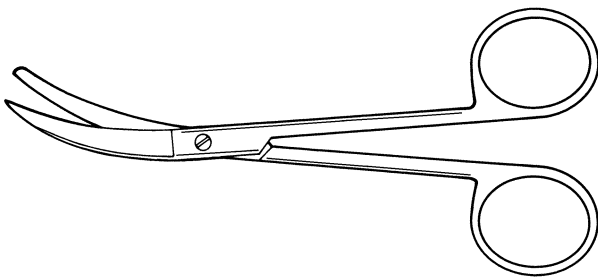

- 17180-10** Dressing Scissor, curved, blunt / sharp, 100mm
- 17180-12** Dressing Scissor, curved, blunt / sharp, 125mm
- 17180-14** Dressing Scissor, curved, blunt / sharp, 140mm
- 17180-15** Dressing Scissor, curved, blunt / sharp, 150mm
- 17180-18** Dressing Scissor, curved, blunt / sharp, 180mm
- 17180-20** Dressing Scissor, curved, blunt / sharp, 200mm

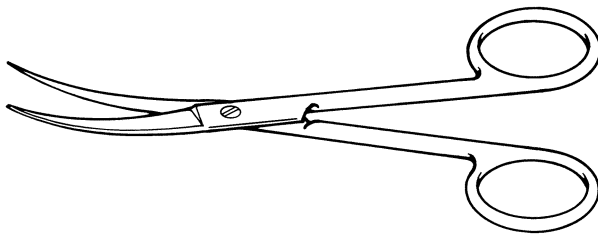

- 17190-10** Dressing Scissor, curved, sharp / sharp, 100mm
- 17190-12** Dressing Scissor, curved, sharp / sharp, 125mm
- 17190-14** Dressing Scissor, curved, sharp / sharp, 140mm
- 17190-15** Dressing Scissor, curved, sharp / sharp, 150mm
- 17190-18** Dressing Scissor, curved, sharp / sharp, 180mm
- 17190-20** Dressing Scissor, curved, sharp / sharp, 200mm

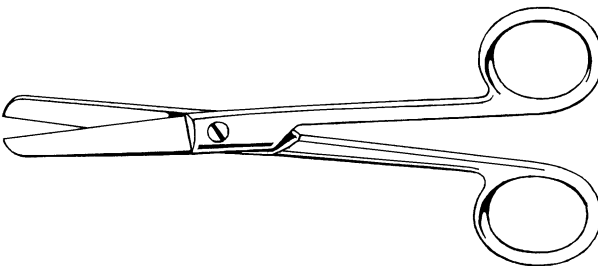

- 17200-10** Dressing Scissor, straight, blunt / blunt, 100mm
- 17200-12** Dressing Scissor, straight, blunt / blunt, 125mm
- 17200-14** Dressing Scissor, straight, blunt / blunt, 140mm
- 17200-15** Dressing Scissor, straight, blunt / blunt, 150mm
- 17200-18** Dressing Scissor, straight, blunt / blunt, 180mm
- 17200-20** Dressing Scissor, straight, blunt / blunt, 200mm

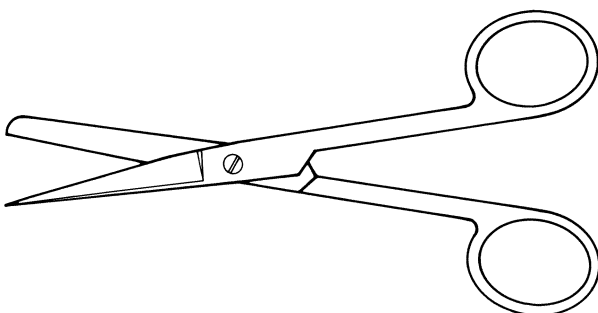

- 17210-10** Dressing Scissor, straight, blunt / sharp, 100mm
- 17210-12** Dressing Scissor, straight, blunt / sharp, 125mm
- 17210-14** Dressing Scissor, straight, blunt / sharp, 140mm
- 17210-15** Dressing Scissor, straight, blunt / sharp, 150mm
- 17210-18** Dressing Scissor, straight, blunt / sharp, 180mm
- 17210-20** Dressing Scissor, straight, blunt / sharp, 200mm

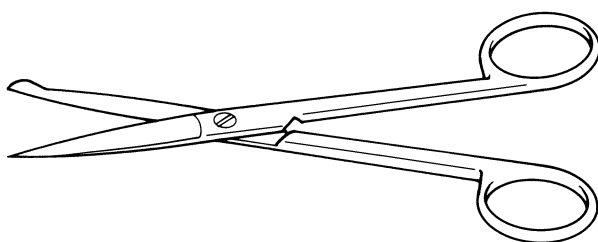

- 17220-12** Dressing Scissor, straight, probe / sharp, 125mm
- 17220-14** Dressing Scissor, straight, probe / sharp, 145mm



- 17230-10 Dressing Scissor, straight, sharp / sharp, 100mm
- 17230-12 Dressing Scissor, straight, sharp / sharp, 125mm
- 17230-14 Dressing Scissor, straight, sharp / sharp, 140mm
- 17230-15 Dressing Scissor, straight, sharp / sharp, 150mm
- 17230-18 Dressing Scissor, straight, sharp / sharp, 180mm
- 17230-20 Dressing Scissor, straight, sharp / sharp, 200mm

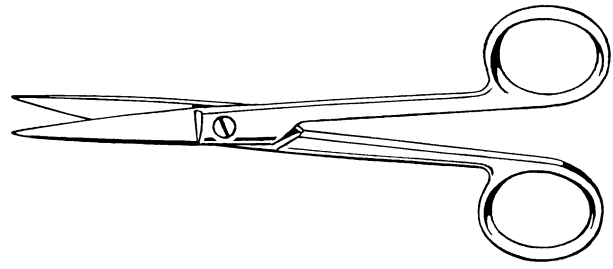

- 17235-08 Elliot Iris Scissor, sharp points, 85mm

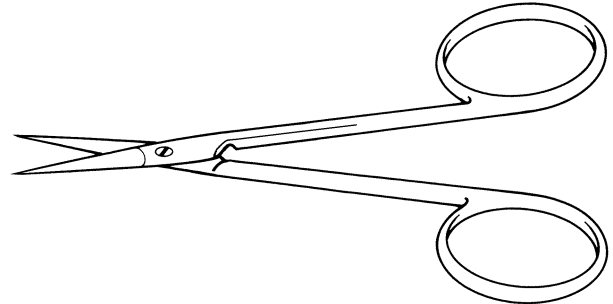

- 17240-14 Fergusson Scissor, 145mm
- 17240-15 Fergusson Scissor, 150mm
- 17240-18 Fergusson Scissor, 180mm

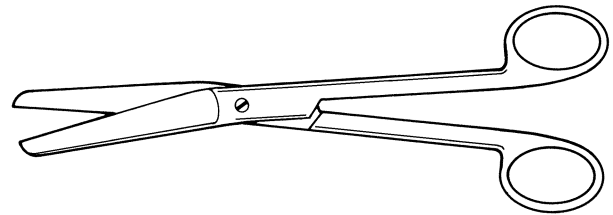

- 17245-10 Glasgow Scissor, straight, fine points, 100mm

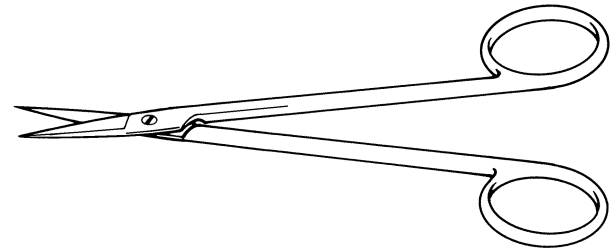

- 17260-15 Heaths Stitch Scissor, 150mm

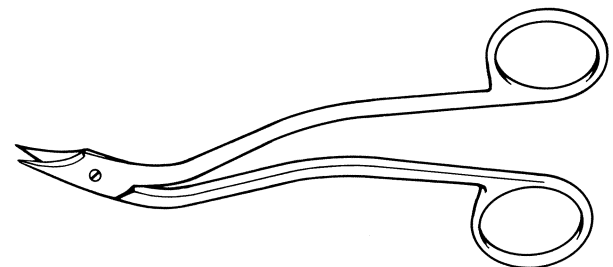

# General

## Scissors

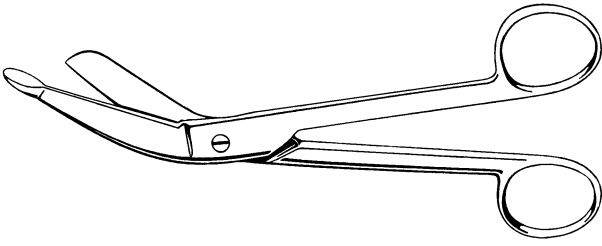

- 17270-14** Listers Bandage Scissor, 140mm
- 17270-18** Listers Bandage Scissor, 180mm
- 17270-20** Listers Bandage Scissor, 200mm
- 17270-23** Listers Bandage Scissor, 235mm

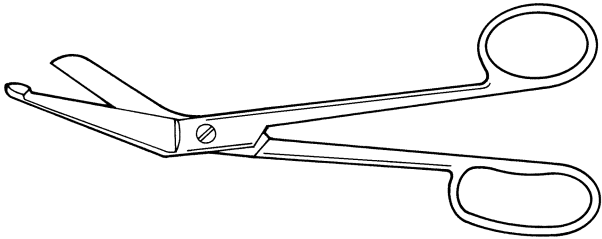

- 17280-18** Listers Bandage Scissor, with double finger bow, 185mm
- 17280-21** Listers Bandage Scissor, with double finger bow, 210mm

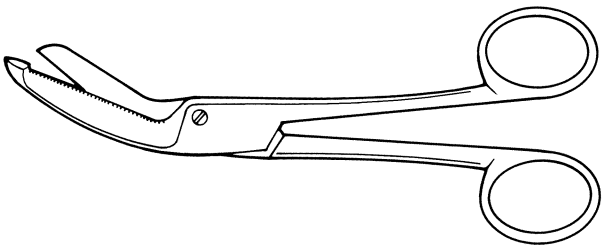

- 17290-16** Listers Eccentric Scissor, 160mm
- 17290-19** Listers Eccentric Scissor, 190mm

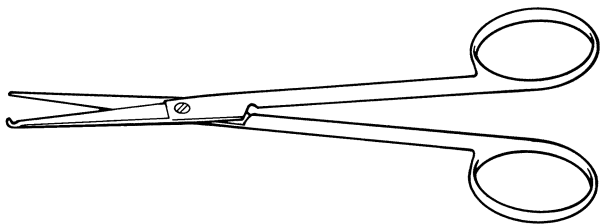

- 17300-12** Littauer Scissor, miniature, straight with hook end, 120mm

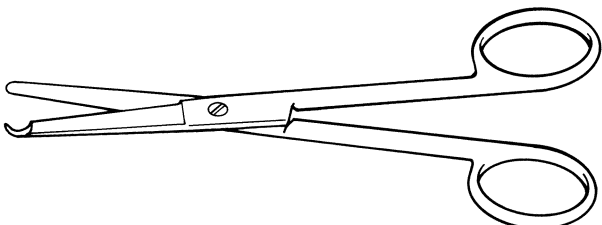

- 17310-12** Littauer Scissor, straight with hook end, 125mm
- 17310-14** Littauer Scissor, straight with hook end, 140mm
- 17310-18** Littauer Scissor, straight with hook end, 180mm
- 17380-14** Metzenbaum Scissor, fine, curved, blunt / blunt, 145mm
- 17380-18** Metzenbaum Scissor, fine, curved, blunt / blunt, 180mm
- 17380-20** Metzenbaum Scissor, fine, curved, blunt / blunt, 200mm
- 17380-23** Metzenbaum Scissor, fine, curved, blunt / blunt, 230mm

- 17330-14 Mayo Scissor, curved, bevelled blades, 140mm
- 17330-16 Mayo Scissor, curved, bevelled blades, 165mm
- 17330-19 Mayo Scissor, curved, bevelled blades, 190mm
- 17330-21 Mayo Scissor, curved, bevelled blades, 215mm

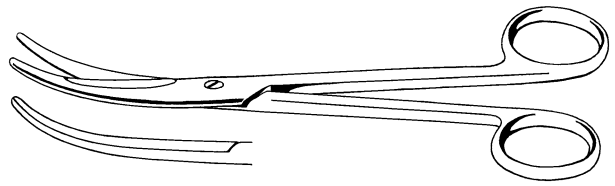

- 17340-14 Mayo Scissor, curved, round blades, 140mm
- 17340-17 Mayo Scissor, curved, round blades, 170mm

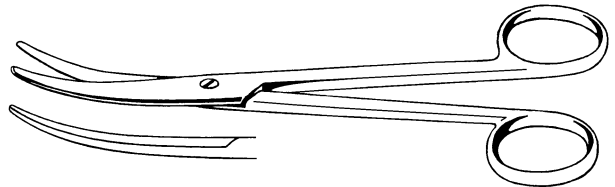

- 17350-14 Mayo Scissor, straight, bevelled blades, 140mm
- 17350-16 Mayo Scissor, straight, bevelled blades, 165mm
- 17350-19 Mayo Scissor, straight, bevelled blades, 190mm
- 17350-21 Mayo Scissor, straight, bevelled blades, 215mm

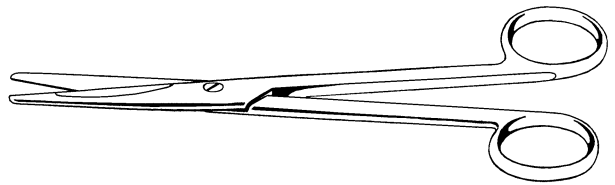

- 17360-14 Mayo Scissor, straight, round blades, 140mm
- 17360-17 Mayo Scissor, straight, round blades, 170mm

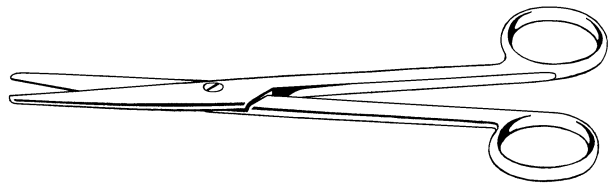

- 17370-14 Metzenbaum Scissor, curved, blunt / blunt, 145mm
- 17370-18 Metzenbaum Scissor, curved, blunt / blunt, 180mm
- 17370-20 Metzenbaum Scissor, curved, blunt / blunt, 200mm
- 17370-23 Metzenbaum Scissor, curved, blunt / blunt, 230mm
- 17370-25 Metzenbaum Scissor, curved, blunt / blunt, 250mm
- 17370-28 Metzenbaum Scissor, curved, blunt / blunt, 280mm
- 17370-30 Metzenbaum Scissor, curved, blunt / blunt, 300mm

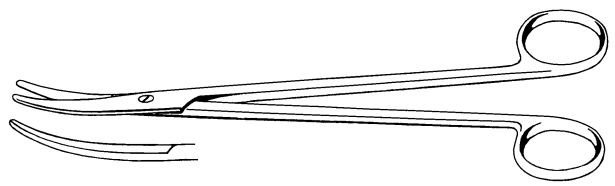

- 17390-14 Metzenbaum Scissor, fine, curved, sharp / sharp, 145mm

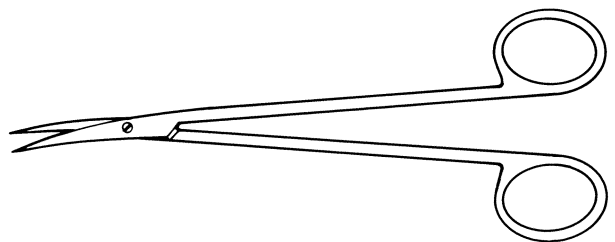

# General

## Scissors

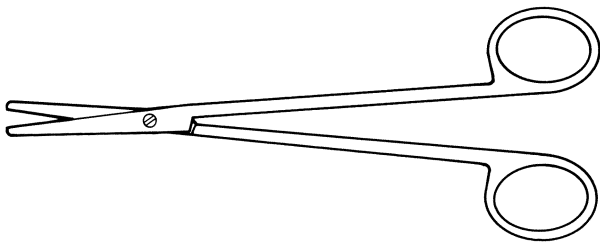

- 17400-14** Metzenbaum Scissor, fine, straight, blunt / blunt, 145mm
- 17400-18** Metzenbaum Scissor, fine, straight, blunt / blunt, 180mm
- 17400-20** Metzenbaum Scissor, fine, straight, blunt / blunt, 200mm
- 17400-23** Metzenbaum Scissor, fine, straight, blunt / blunt, 230mm

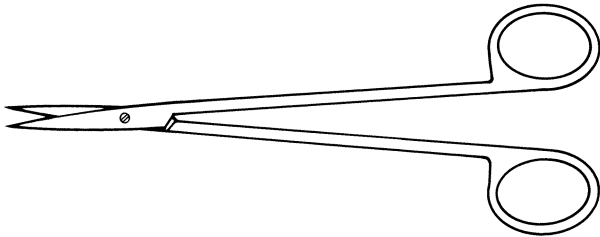

- 17410-14** Metzenbaum Scissor, fine, straight, sharp / sharp, 145mm

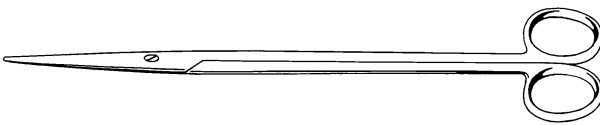

- 17420-14** Metzenbaum Scissor, straight, blunt / blunt, 145mm
- 17420-18** Metzenbaum Scissor, straight, blunt / blunt, 180mm
- 17420-20** Metzenbaum Scissor, straight, blunt / blunt, 200mm
- 17420-23** Metzenbaum Scissor, straight, blunt / blunt, 230mm
- 17420-25** Metzenbaum Scissor, straight, blunt / blunt, 250mm
- 17420-28** Metzenbaum Scissor, straight, blunt / blunt, 280mm
- 17420-30** Metzenbaum Scissor, straight, blunt / blunt, 300mm

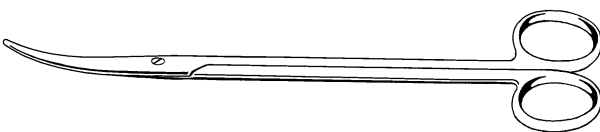

- 17430-23** Nelson Lobectomy Scissor, curved, 230mm

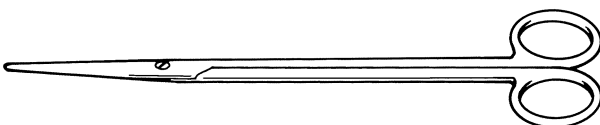

- 17440-23** Nelson Lobectomy Scissor, straight, 230mm

17450-14 Post Mortem Scissor, ball end, open shank, 140mm

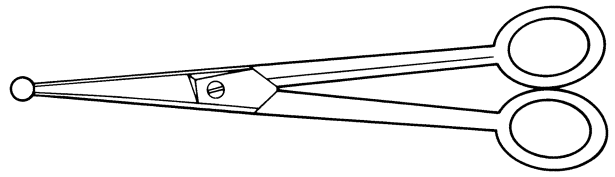

17460-10 Post Mortem Scissor, probe / sharp, open shank, 100mm

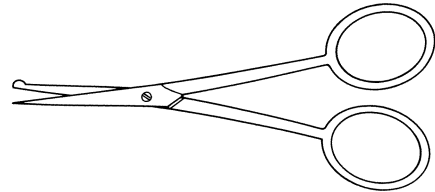

17490-10 Spencer Scissor, hook end, 105mm

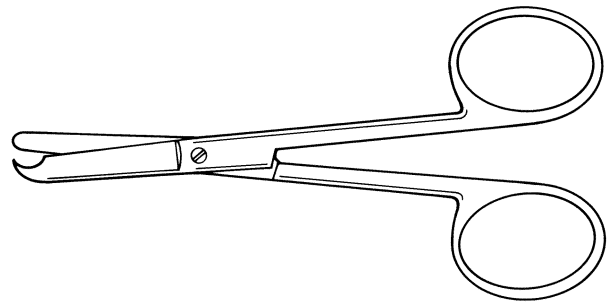

17493-11 Stevens Scissor, curved, blunt, 115mm

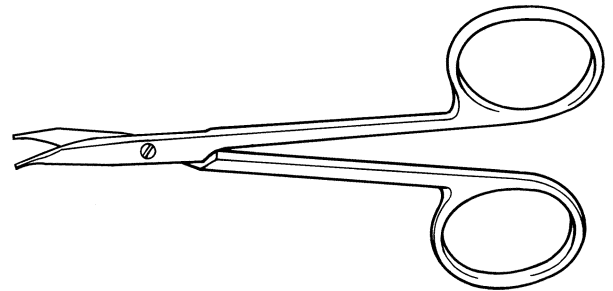

17494-11 Stevens Scissor, curved, sharp, 115mm

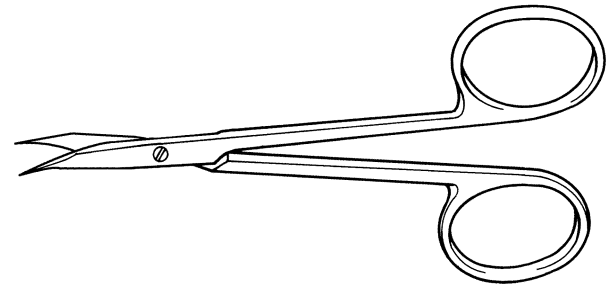

# General

## Scissors

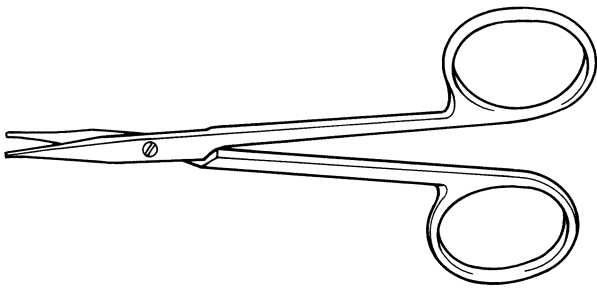

17495-11 Stevens Scissor, straight, blunt, 115mm

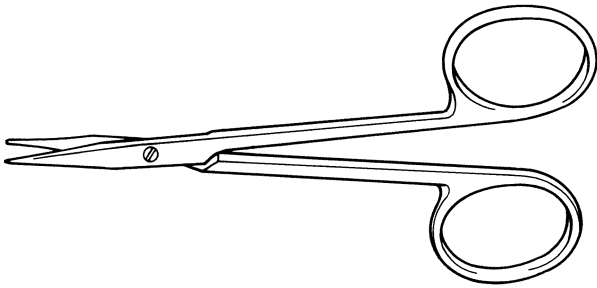

17496-11 Stevens Scissor, straight, sharp, 115mm

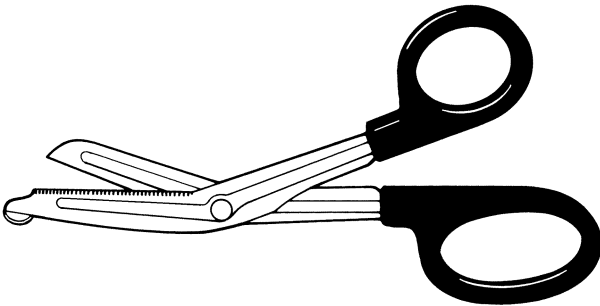

17500-17 Universal Bandage Scissor, saw edge, autoclavable handles, 175mm

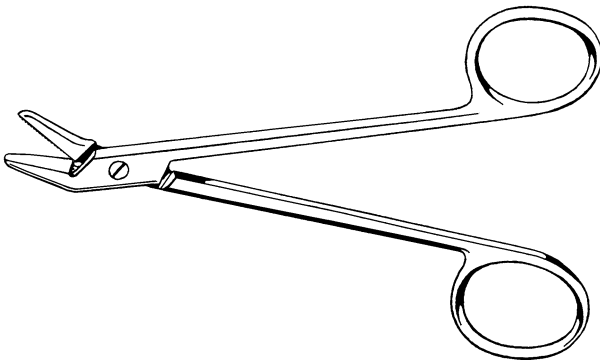

17510-12 Universal Wire Cutting Scissor, saw edge, 120mm

**Scissors - Tungsten Carbide**

- 17700-14** Dressing Scissor, tungsten carbide, curved, blunt / blunt, 145mm
- 17710-14** Dressing Scissor, tungsten carbide, curved, blunt / sharp, 145mm
- 17720-14** Dressing Scissor, tungsten carbide, curved, sharp / sharp, 145mm

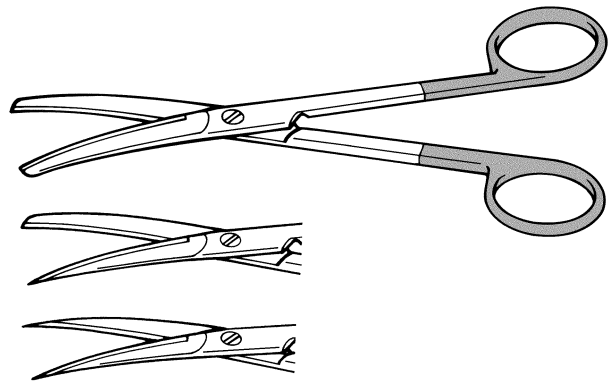

- 17730-14** Dressing Scissor, tungsten carbide, straight, blunt / blunt, 145mm
- 17740-14** Dressing Scissor, tungsten carbide, straight, blunt / sharp, 145mm
- 17750-14** Dressing Scissor, tungsten carbide, straight, sharp / sharp, 145mm

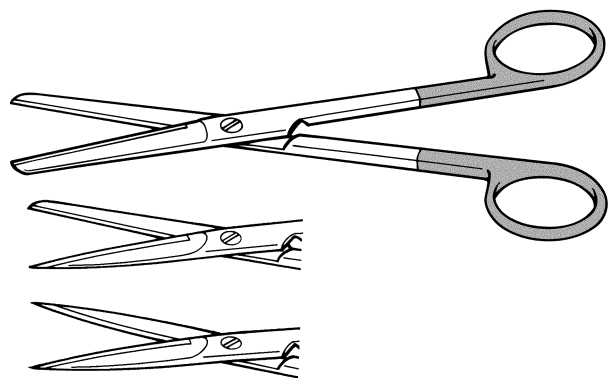

- 17755-11** Iris Scissor, tungsten carbide, curved, sharp, 115mm
- 17756-11** Iris Scissor, tungsten carbide, straight, sharp, 115mm

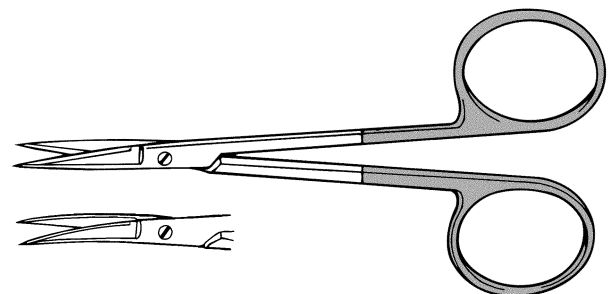

- 17760-14** Mayo Scissor, tungsten carbide, curved, 145mm
- 17760-17** Mayo Scissor, tungsten carbide, curved, 170mm
- 17760-19** Mayo Scissor, tungsten carbide, curved, 190mm
- 17770-14** Mayo Scissor, tungsten carbide, straight, 145mm
- 17770-17** Mayo Scissor, tungsten carbide, straight, 170mm
- 17770-19** Mayo Scissor, tungsten carbide, straight, 190mm

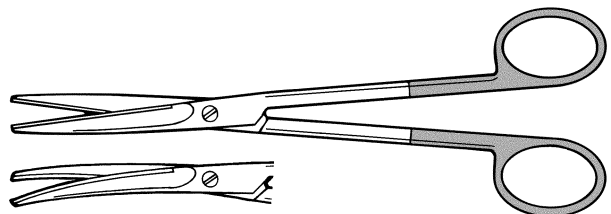

## General

### Scissors - Tungsten Carbide

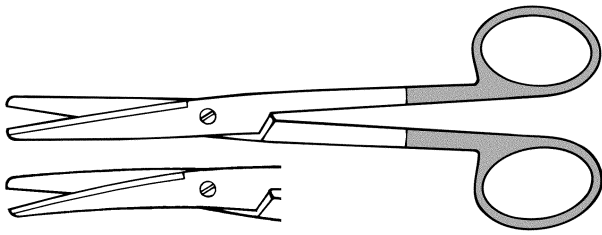

- 17780-15** Mayo-Stille Scissor , tungsten carbide, curved, 150mm
- 17780-17** Mayo-Stille Scissor , tungsten carbide, curved, 170mm
- 17790-15** Mayo-Stille Scissor , tungsten carbide, straight, 150mm
- 17790-17** Mayo-Stille Scissor , tungsten carbide, straight, 170mm

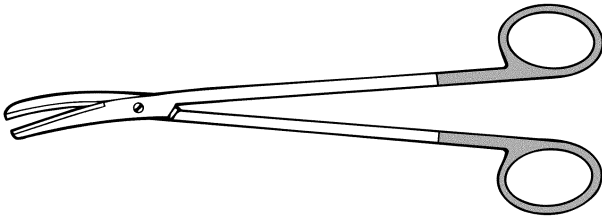

- 17800-14** Metzenbaum Scissor, tungsten carbide, curved, blunt / blunt, 145mm
- 17800-17** Metzenbaum Scissor, tungsten carbide, curved, blunt / blunt, 180mm
- 17800-20** Metzenbaum Scissor, tungsten carbide, curved, blunt / blunt, 200mm
- 17800-23** Metzenbaum Scissor, tungsten carbide, curved, blunt / blunt, 230mm

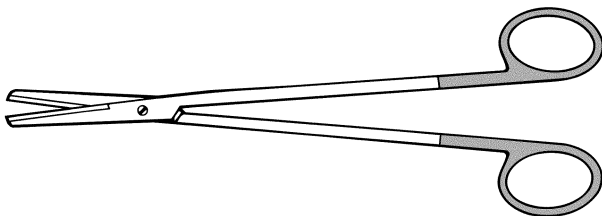

- 17810-14** Metzenbaum Scissor, tungsten carbide, straight, blunt / blunt, 145mm
- 17810-17** Metzenbaum Scissor, tungsten carbide, straight, blunt / blunt, 180mm
- 17810-20** Metzenbaum Scissor, tungsten carbide, straight, blunt / blunt, 200mm
- 17810-23** Metzenbaum Scissor, tungsten carbide, straight, blunt / blunt, 230mm

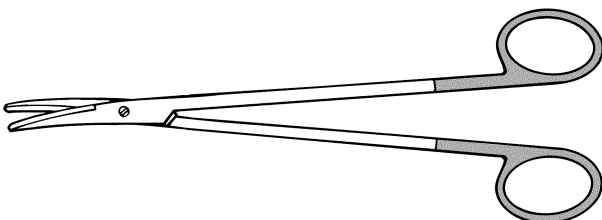

- 17815-23** Nelson Lobectomy Scissor, tungsten carbide, curved, 230mm

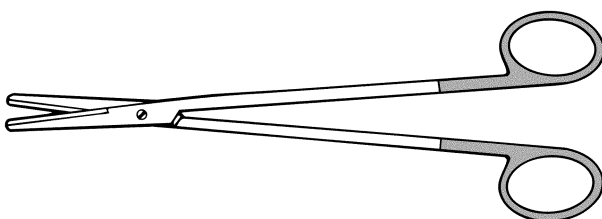

- 17816-23** Nelson Lobectomy Scissor, tungsten carbide, straight, 230mm



**Scissors - Tungsten Carbide**

**17820-12** Universal Wire Cutting Scissor, tungsten carbide, 120mm

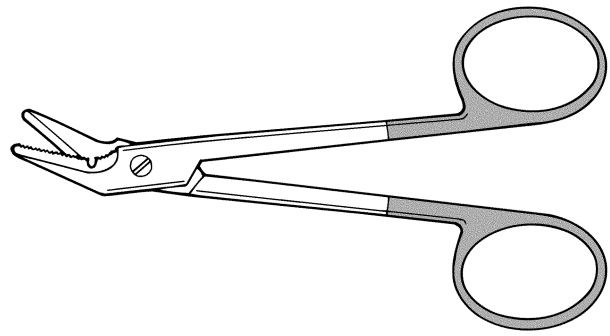

**Scissors - Ultra Cutting**

**17600-14** Dressing Scissor, ultra cutting, curved, blunt / sharp, 145mm

**17610-14** Dressing Scissor, ultra cutting, straight, blunt / sharp, 145mm

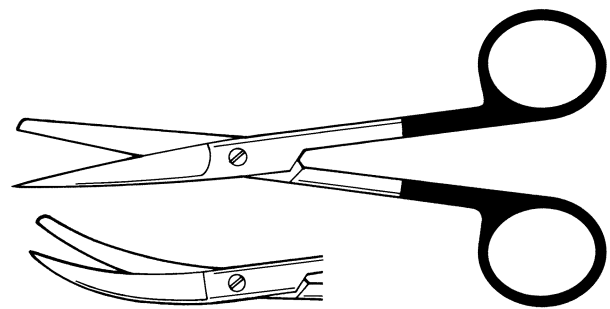

**17620-11** Iris Scissor, ultra cutting, curved, 115mm

**17630-11** Iris Scissor, ultra cutting, straight, 115mm

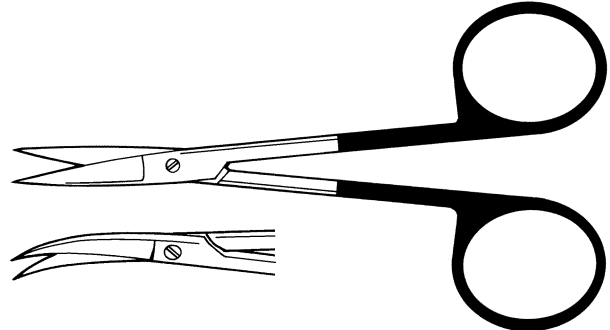

**17635-11** Kilner Scissor, ultra cutting, curved, blunt, 110mm

**17636-11** Kilner Scissor, ultra cutting, straight, sharp, 110mm

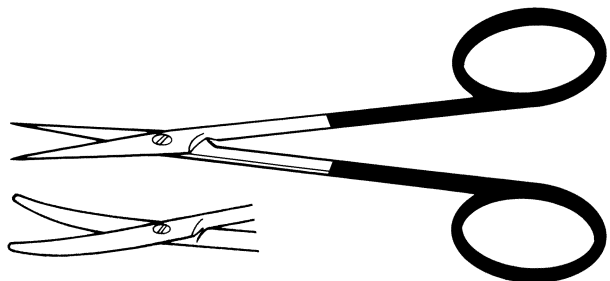

# General

## Scissors - Ultra Cutting

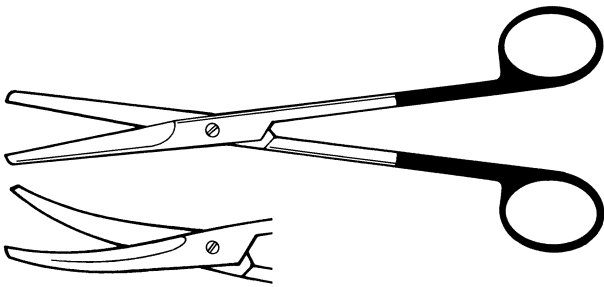

- 17640-14 Mayo Scissor, ultra cutting, curved, 145mm
- 17640-17 Mayo Scissor, ultra cutting, curved, 170mm
- 17640-20 Mayo Scissor, ultra cutting, curved, 200mm
- 17640-21 Mayo Scissor, ultra cutting, curved, 215mm
- 17650-14 Mayo Scissor, ultra cutting, straight, 145mm
- 17650-17 Mayo Scissor, ultra cutting, straight, 170mm
- 17650-20 Mayo Scissor, ultra cutting, straight, 200mm
- 17650-21 Mayo Scissor, ultra cutting, straight, 215mm

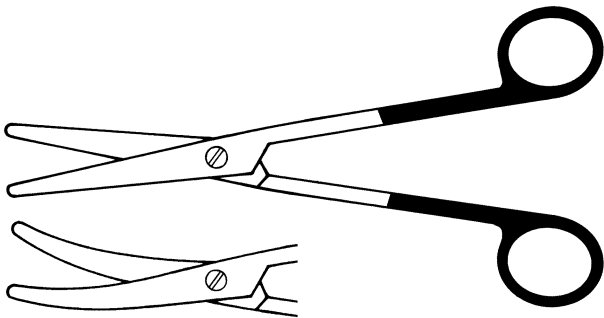

- 17655-15 Mayo-Stille Scissor, ultra cutting, curved, 150mm
- 17655-17 Mayo-Stille Scissor, ultra cutting, curved, 170mm
- 17655-19 Mayo-Stille Scissor, ultra cutting, curved, 190mm
- 17656-15 Mayo-Stille Scissor, ultra cutting, straight, 150mm
- 17656-17 Mayo-Stille Scissor, ultra cutting, straight, 170mm
- 17656-19 Mayo-Stille Scissor, ultra cutting, straight, 190mm

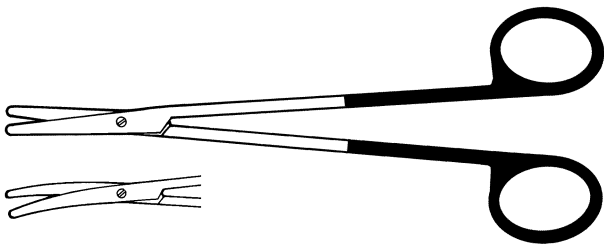

- 17660-14 Metzenbaum Scissor, ultra cutting, curved, 145mm
- 17660-18 Metzenbaum Scissor, ultra cutting, curved, 180mm
- 17660-20 Metzenbaum Scissor, ultra cutting, curved, 200mm
- 17660-23 Metzenbaum Scissor, ultra cutting, curved, 230mm
- 17660-26 Metzenbaum Scissor, ultra cutting, curved, 260mm
- 17670-14 Metzenbaum Scissor, ultra cutting, straight, 145mm

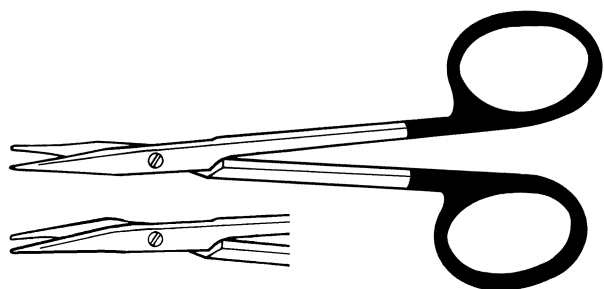

- 17680-11 Stevens Scissor, ultra cutting, curved, 110mm
- 17681-11 Stevens Scissor, ultra cutting, straight, 110mm

**Scissors - Ultra Cutting**

- 17690-11 Strabismus Scissor, ultra cutting, curved, 110mm
- 17691-11 Strabismus Scissor, ultra cutting, straight, 110mm

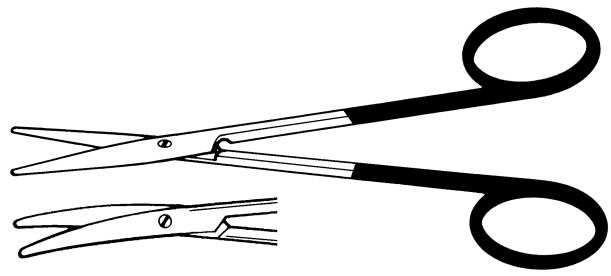

**Sinus Forceps**

- 18000-12 Lister Sinus Forcep, serrated tip, 125mm
- 18000-15 Lister Sinus Forcep, serrated tip, 150mm
- 18000-18 Lister Sinus Forcep, serrated tip, 180mm
- 18000-20 Lister Sinus Forcep, serrated tip, 200mm

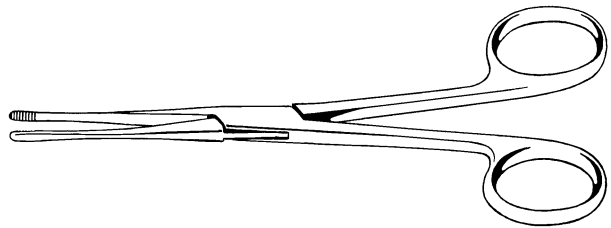

**Splinter Forceps**

- 18200-12 Arthur Splinter Forcep, pointed, serrated jaws, 125mm

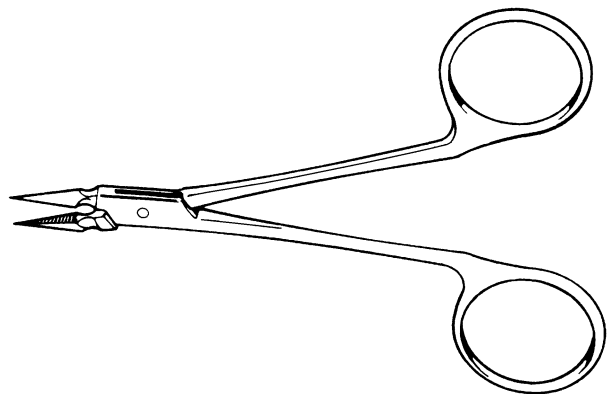

- 18210-10 Hunter Splinter Forcep, straight, 105mm

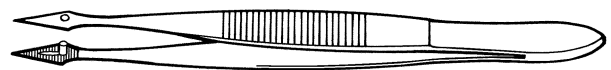

- 18220-07 Martin Splinter Forcep, 75mm
- 18220-09 Martin Splinter Forcep, 90mm
- 18220-11 Martin Splinter Forcep, 115mm



## General

### Sponge Holding Forceps

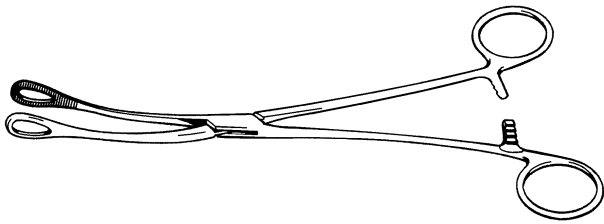

- 18300-18** Foerster Sponge Holding Forcep, curved, serrated jaws, 180mm
- 18300-24** Foerster Sponge Holding Forcep, curved, serrated jaws, 240mm

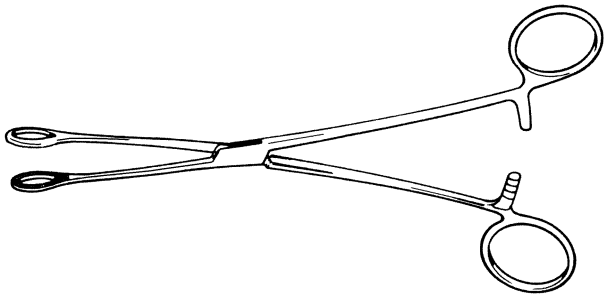

- 18310-18** Foerster Sponge Holding Forcep, straight, serrated jaws, 180mm
- 18310-24** Foerster Sponge Holding Forcep, straight, serrated jaws, 240mm

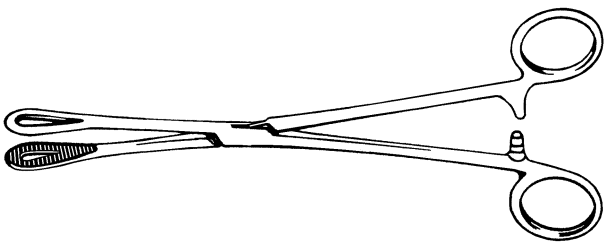

- 18320-18** Rampley Sponge Holding Forcep, straight, serrated jaws, 180mm
- 18320-24** Rampley Sponge Holding Forcep, straight, serrated jaws, 240mm

### Steriliser Forceps

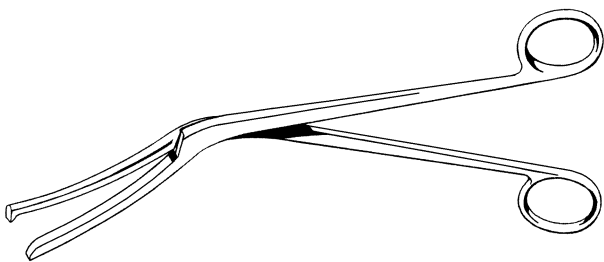

- 18410-26** Cheattle Steriliser Forcep, light, box joint, 265mm

### Suction Tubes

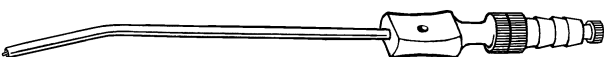

- 18600-10** American Pattern Suction Tube, s/s, with stillette, 165mm



- 18601-10** American Pattern Suction Tube, s/s, insulated, with stillette, 165mm

Suction Tubes

18610-17 Lawrie Extension, s/s, 175mm

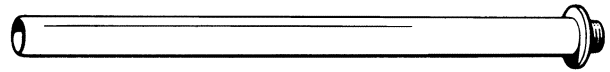

18620-10 Millin Suction Tube

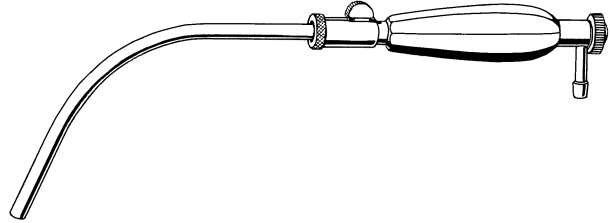

18650-24 Poole Suction Tube, s/s, curved mount, 240mm, 10mm dia.

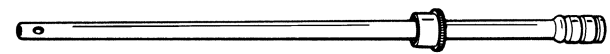

18660-24 Poole Suction Tube, s/s, straight mount, 240mm, 10mm dia.

18664-15 Poole Suction Tube, s/s, paediatric, straight mount, 155mm, 6mm dia.



18665-31 Simpson Smith Suction Tube, thumb button control, detachable inner suction tube and perforated sheath

18665-50 Simpson Smith Suction Tube, spare spring only

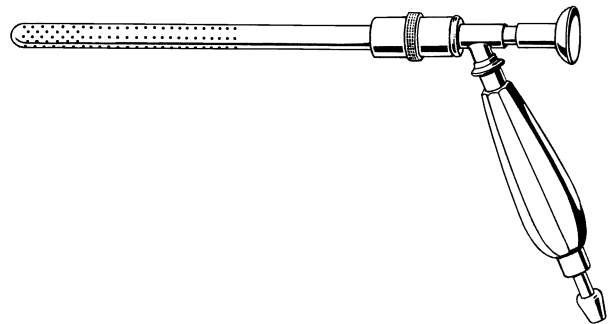

18670-25 Tinckler (Simpson Smith) Suction Tube, with on / off valve, 150mm, 255mm

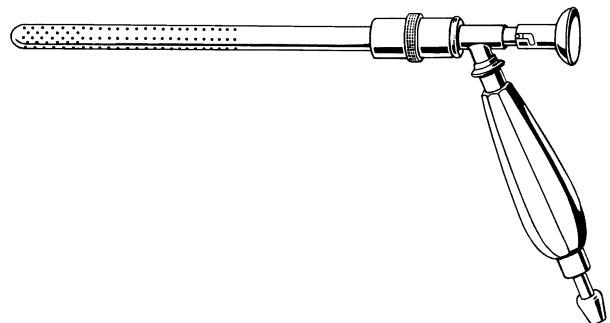

# General

## Suction Tubes

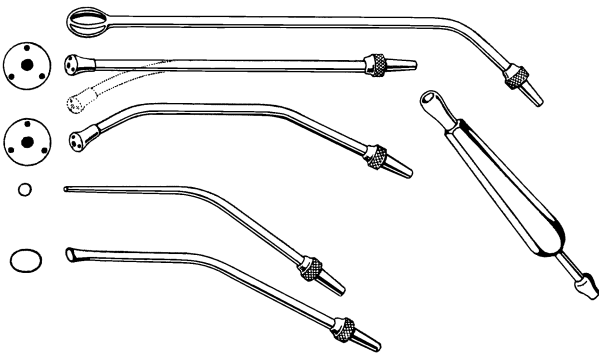

- 18680-10** Universal Suction Tube, handle only
- 18680-20** Universal Suction Tube, abdominal tube, fenestrated tip
- 18680-30** Universal Suction Tube, bent tube, oval open tip
- 18680-40** Universal Suction Tube, bent tube, round open tip
- 18680-50** Universal Suction Tube, malleable tube, perforated tip
- 18680-60** Universal Suction Tube, yankauer tube, perforated tip
- 18680-90** Universal Suction Tube, complete set, handle and 5 interchangeable ends

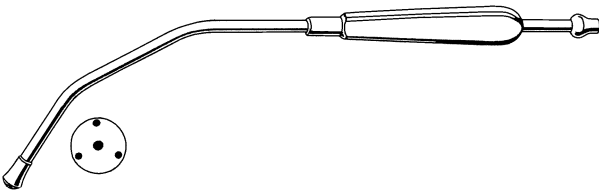

- 18700-30** Yankauer Suction Tube, s/s, 305mm
- 18700-50** Yankauer Suction Tube, s/s, spare tip only

## Suture Forceps

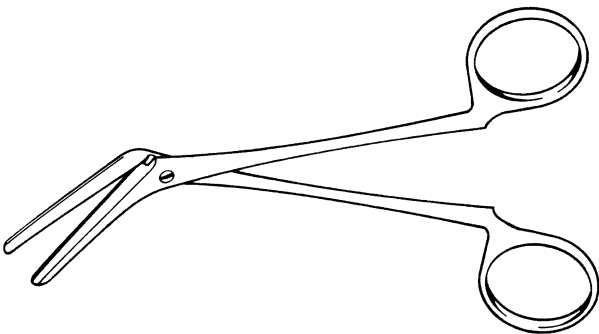

- 18800-15** Guy's Suture Forcep, angled flat blades, screw joint, 150mm

## Tissue Forceps

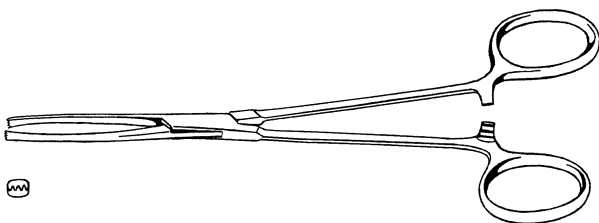

- 18900-30** Allis (American Pattern) Tissue Forcep, 160mm, 3/4 teeth

Tissue Forceps

- 18910-20 Allis Tissue Forcep, 150mm, 2/3 teeth
- 18910-30 Allis Tissue Forcep, 150mm, 3/4 teeth
- 18910-40 Allis Tissue Forcep, 150mm, 4/5 teeth
- 18910-50 Allis Tissue Forcep, 150mm, 5/6 teeth
- 18910-60 Allis Tissue Forcep, 150mm, 6/7 teeth

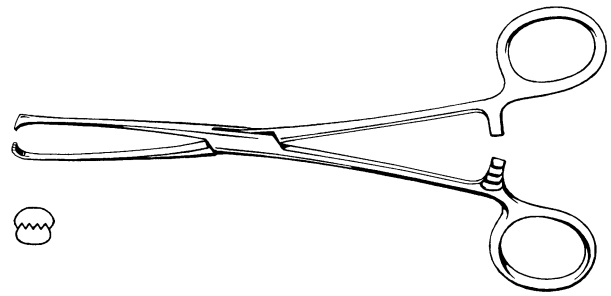

- 18920-16 Babcock Tissue Forcep, serrated jaws, 165mm
- 18920-20 Babcock Tissue Forcep, serrated jaws, 200mm
- 18920-23 Babcock Tissue Forcep, serrated jaws, 230mm

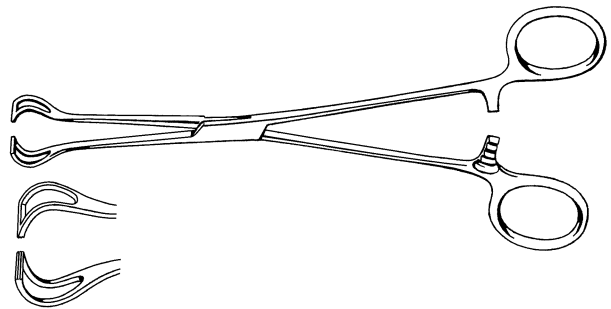

- 18930-13 Duval Tissue Forcep, serrated, 190mm, 13mm jaws

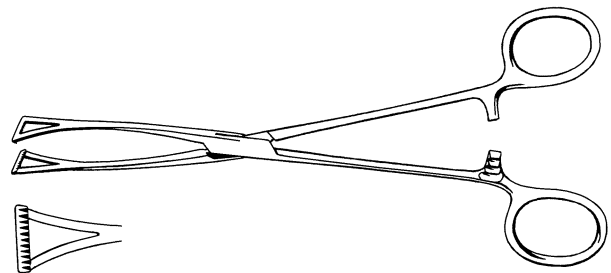

- 18940-19 Judd-Allis Tissue Forcep, 195mm, 3/4 teeth

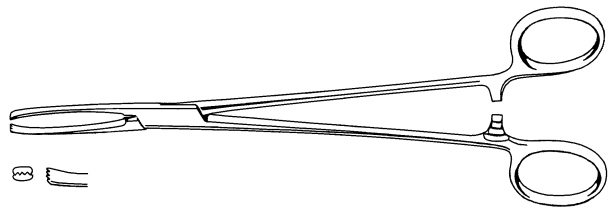

# General

## Tissue Forceps

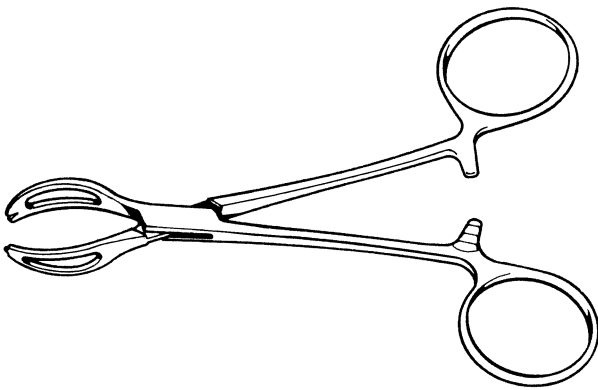

- 18950-12** Lanes Tissue Forcep, 1/2 teeth, fenestrated, 125mm
- 18950-15** Lanes Tissue Forcep, 1/2 teeth, fenestrated, 150mm
- 18950-19** Lanes Tissue Forcep, 1/2 teeth, fenestrated, 195mm

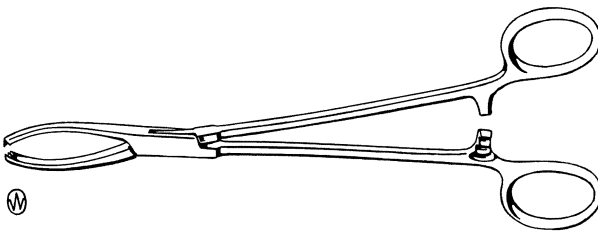

- 18960-18** Littlewood Tissue Forcep, 2/3 teeth, 190mm

## Tongue Forceps

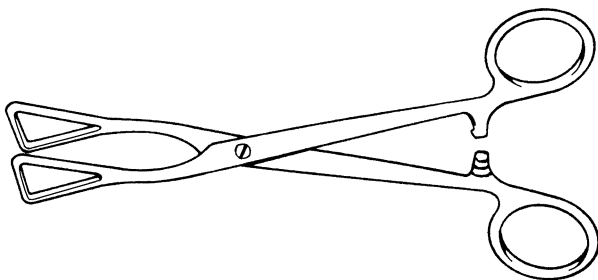

- 19000-13** Guys Tongue Forcep, screw joint, child, 130mm
- 19000-17** Guys Tongue Forcep, screw joint, adult, 175mm

## Towel Clips

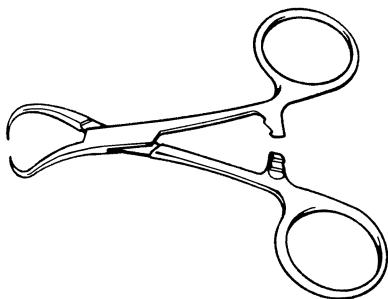

- 19100-09** Backhaus Towel Clip, 90mm



**Towel Clips**

19100-12 Backhaus Towel Clip, 125mm

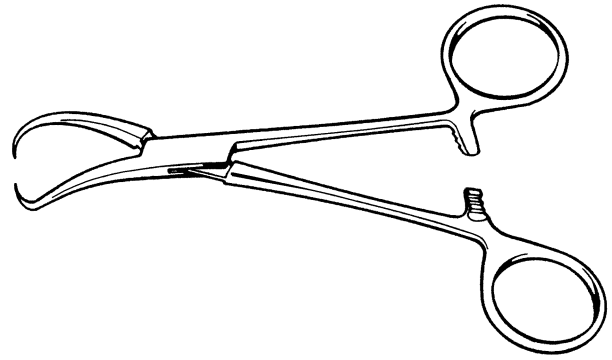

19130-09 Frenchay Towel Clip, cross action, non-penetrating, 90mm

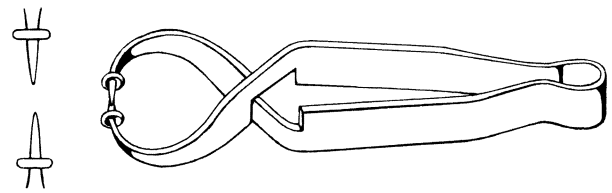

19150-09 Shardle Towel Clip, cross action, 90mm

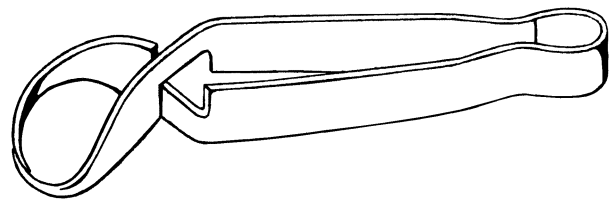

**Trocars**

19170-16 Ascites Trocar, 16FG  
19170-21 Ascites Trocar, 21FG

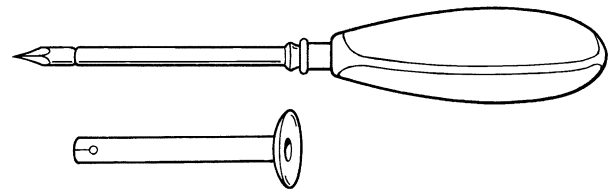

19200-08 Hydrocele Trocar, 8FG  
19200-09 Hydrocele Trocar, 9FG  
19200-10 Hydrocele Trocar, 10FG

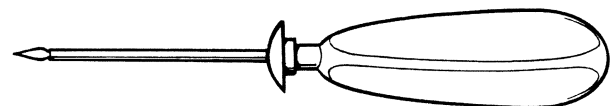

19210-22 Nelson Trocar, 22FG  
19210-27 Nelson Trocar, 27FG  
19210-33 Nelson Trocar, 33FG

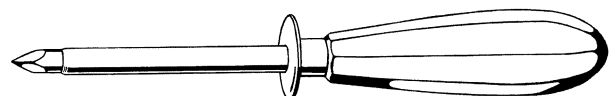

# General

## Vein Strippers

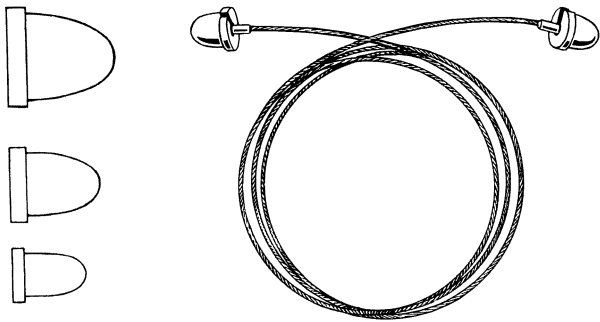

- 19280-06** Graves Myers Vein Stripper, acorn only, 6mm
- 19280-10** Graves Myers Vein Stripper, acorn only, 10mm
- 19280-13** Graves Myers Vein Stripper, acorn only, 13mm
- 19280-50** Graves Myers Vein Stripper, cable only, 900mm
- 19280-60** Graves Myers Vein Stripper, 'T' handle only
- 19280-90** Graves Myers Vein Stripper, complete, 3 acorns, cable, 'T' handle

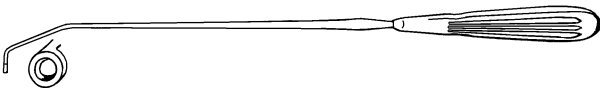
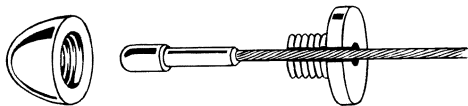

- 19289-05** Mayo External Vein Stripper, 330mm, 5mm bore, 8mm o.d., Codman pattern
- 19289-07** Mayo External Vein Stripper, 330mm, 7mm bore, 10mm o.d., Codman pattern
- 19289-09** Mayo External Vein Stripper, 330mm, 9mm bore, 12mm o.d., Codman pattern



- 19290-05** Mayo External Vein Stripper, 385mm, 5mm bore, 8mm o.d., Pilling pattern
- 19290-07** Mayo External Vein Stripper, 385mm, 7mm bore, 10mm o.d., Pilling pattern
- 19290-09** Mayo External Vein Stripper, 385mm, 9mm bore, 12mm o.d., Pilling pattern

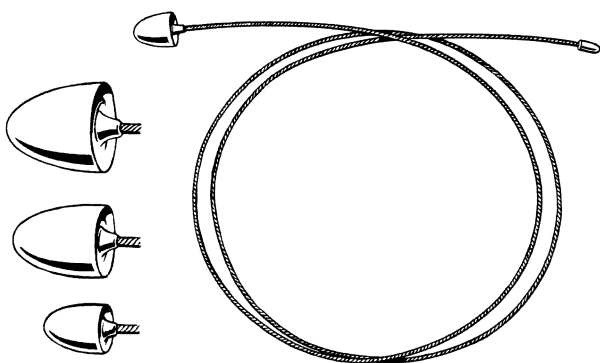

- 19300-06** Myer Vein Stripper, length 890mm, 6mm
- 19300-10** Myer Vein Stripper, length 890mm, 10mm
- 19300-13** Myer Vein Stripper, length 890mm, 13mm
- 19300-50** Myer Vein Stripper, handle only

- 19310-06** Nabatoff Vein Stripper, acorn only, 6mm, 7BA
- 19310-09** Nabatoff Vein Stripper, acorn only, 9mm, 7BA
- 19310-12** Nabatoff Vein Stripper, acorn only, 12mm, 7BA
- 19310-15** Nabatoff Vein Stripper, acorn only, 15mm, 7BA
- 19310-20** Nabatoff Vein Stripper, cylindrical probe tip only, 10swg, 7BA
- 19310-50** Nabatoff Vein Stripper, cable only, 16 swg, 900mm, 7BA
- 19310-55** Nabatoff Vein Stripper, rack only, 7BA
- 19310-60** Nabatoff Vein Stripper, 'T' handle only, 7BA
- 19310-65** Nabatoff Vein Stripper, case only
- 19310-90** Nabatoff Vein Stripper, complete in case, 4 acorns, 2 cylindrical probe tips, cable, 'T' handle, rack, 7BA
- 19320-06** Nabatoff Vein Stripper, acorn only, 6mm, 6BA
- 19320-09** Nabatoff Vein Stripper, acorn only, 9mm, 6BA
- 19320-12** Nabatoff Vein Stripper, acorn only, 12mm, 6BA
- 19320-15** Nabatoff Vein Stripper, acorn only, 15mm, 6BA
- 19320-20** Nabatoff Vein Stripper, cylindrical probe tip only, 10swg, 6BA
- 19320-50** Nabatoff Vein Stripper, cable only, 16 swg, 900mm, 6BA
- 19320-55** Nabatoff Vein Stripper, rack only, 6BA
- 19320-60** Nabatoff Vein Stripper, 'T' handle only, 6BA

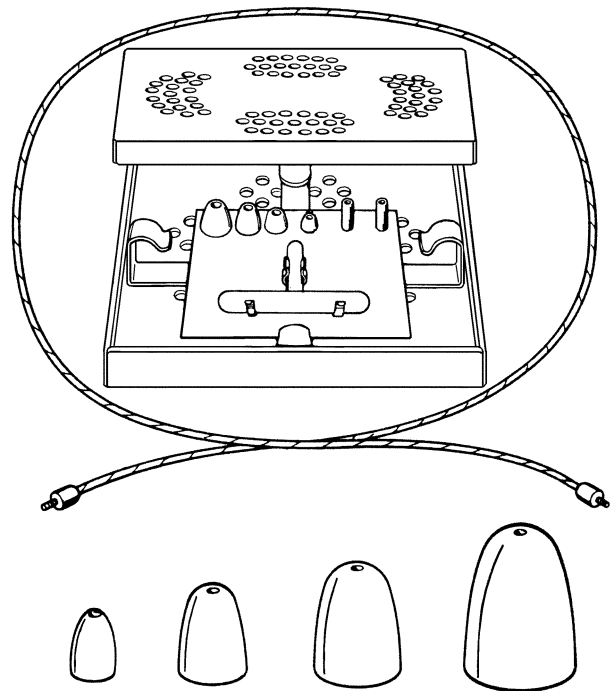

# Plastic and Maxillo Facial

## Awls



**21000-22** Obwegeser Alveolar-Pernasal Wiring Awl, 225mm



**21010-10** Kelsey Fry Bone Awl, curved, standard pattern

**21015-10** Kelsey Fry Bone Awl, curved, lightweight pattern



**21020-14** Kelsey Fry Bone Awl, straight, standard pattern, 145mm

**21025-14** Kelsey Fry Bone Awl, straight, lightweight pattern, 145mm

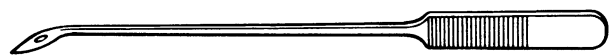

**21030-14** Obwegeser Mandibular Awl, 140mm



**21040-18** Obwegeser Zygomatic Suspension Awl, 180mm

## Chisels

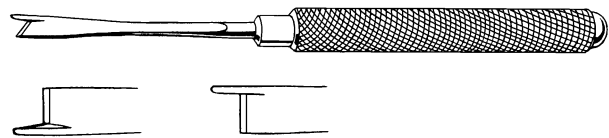

**21200-05** Braithwaite Chisel, guard on left, 5mm

**21210-05** Braithwaite Chisel, guard on right, 5mm

**21220-05** Braithwaite Chisel, unguarded, 5mm



**21230-10** Cottle Nasal Chisel, No.1, 5mm, 185mm



**21230-20** Cottle Nasal Chisel, No.2, 6mm, 185mm



**21230-30** Cottle Nasal Chisel, No.3, 7mm, 185mm



**21230-40** Cottle Nasal Chisel, No.4, 9mm, 185mm



**21230-50** Cottle Nasal Chisel, No.5, 11mm, 185mm

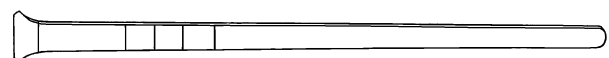

**21230-60** Cottle Nasal Chisel, No.6, 16mm, 185mm, fish tail

- 21235-03** Eastman Dental Chisel, length 190mm, 3mm  
**21235-05** Eastman Dental Chisel, length 190mm, 5mm

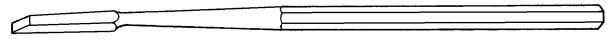

- 21238-04** Fomon Chisel, with guard, 165mm, 4mm  
**21238-05** Fomon Chisel, with guard, 165mm, 5mm  
**21238-06** Fomon Chisel, with guard, 165mm, 6mm  
**21238-07** Fomon Chisel, with guard, 165mm, 7mm



- 21240-18** Frenchay Chisel, curved to left, length 180mm

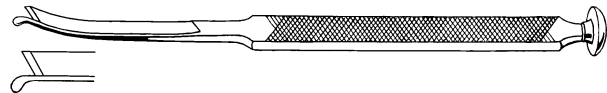

- 21250-18** Frenchay Chisel, curved to right, length 180mm

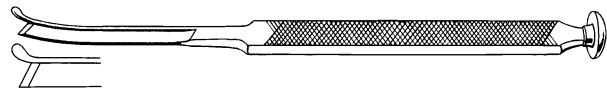

- 21260-18** Frenchay Chisel, straight, length 180mm

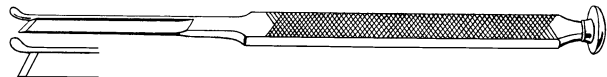

- 21270-02** Jenkins Chisel, length 145mm, 2mm  
**21270-04** Jenkins Chisel, length 145mm, 4mm  
**21270-06** Jenkins Chisel, length 145mm, 6mm  
**21270-08** Jenkins Chisel, length 145mm, 8mm  
**21270-10** Jenkins Chisel, length 145mm, 10mm  
**21270-12** Jenkins Chisel, length 145mm, 12mm  
**21270-14** Jenkins Chisel, length 145mm, 14mm

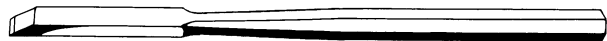

- 21280-10** MacEwen Chisel, hard edge, 10mm  
**21280-13** MacEwen Chisel, hard edge, 13mm  
**21280-20** MacEwen Chisel, hard edge, 20mm  
**21280-25** MacEwen Chisel, hard edge, 25mm  
**21280-30** MacEwen Chisel, hard edge, 30mm

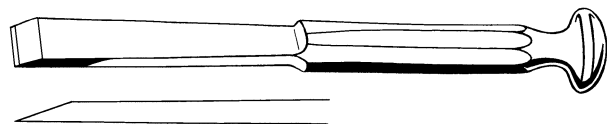

- 21290-09** McIndoe Chisel, length 150mm, 9mm  
**21290-11** McIndoe Chisel, length 150mm, 11mm  
**21290-13** McIndoe Chisel, length 150mm, 13mm  
**21290-15** McIndoe Chisel, length 150mm, 15mm



# Plastic and Maxillo Facial

## Chisels



- 21300-09** McIndoe Chisel, mushroom head, length 150mm, 9mm
- 21300-11** McIndoe Chisel, mushroom head, length 150mm, 11mm
- 21300-13** McIndoe Chisel, mushroom head, length 150mm, 13mm
- 21300-15** McIndoe Chisel, mushroom head, length 150mm, 15mm

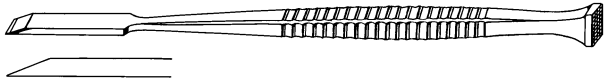

- 21310-02** Read Chisel, length 180mm, 2mm
- 21310-03** Read Chisel, length 180mm, 3mm
- 21310-04** Read Chisel, length 180mm, 4mm
- 21310-05** Read Chisel, length 180mm, 5mm
- 21310-06** Read Chisel, length 180mm, 6mm
- 21310-07** Read Chisel, length 180mm, 7mm
- 21310-08** Read Chisel, length 180mm, 8mm



- 21320-03** Ward Chisel, length 180mm, 3mm
- 21320-04** Ward Chisel, length 180mm, 4mm
- 21320-05** Ward Chisel, length 180mm, 5mm

## Collar Crushing Forceps

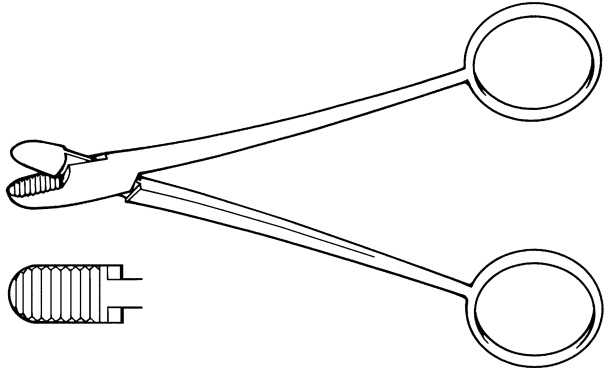

- 21400-14** Denis Browne Collar Crushing Forcep, 140mm

## Curettes



- 21500-17** Exner Curette, double ended, angled oval ends, 175mm

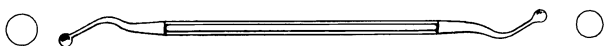

- 21510-17** Exner Curette, double ended, angled round ends, 175mm



- 21520-17** Exner Curette, double ended, oval/round ends, 175mm

## Curettes

**21530-18** McEwen Curette, double ended, 180mm, oval

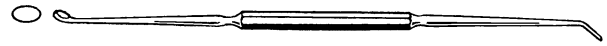

**21540-18** McEwen Curette, double ended, 180mm, round

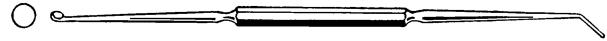

## Dermabrasion Cylinders

**21600-15** Bodenham Dermabrasion Cylinder, coated with silicon carbide granules, small, 15mm x 18mm dia.

**21600-28** Bodenham Dermabrasion Cylinder, coated with silicon carbide granules, large, 28mm x 18mm dia.

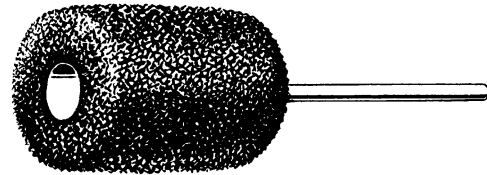

## Dissecting Forceps

**21700-10** Mount Vernon Dissecting Forcep, serrated, 100mm



**21705-14** Lanes Dissecting Forcep, rough handle, 1/2 teeth, 140mm

**21705-18** Lanes Dissecting Forcep, rough handle, 1/2 teeth, 180mm

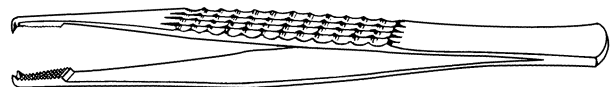

## Elevators

**21800-23** Bristow Malar Elevator, 230mm

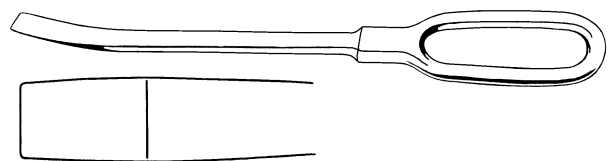

**21810-10** Cryer Exolever, left

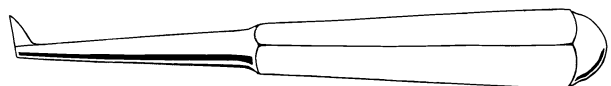

**21820-10** Cryer Exolever, right

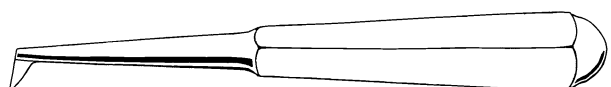

# Plastic and Maxillo Facial

## Elevators

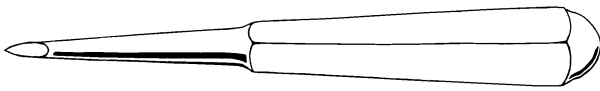

**21830-10** Cryer Exolever, straight

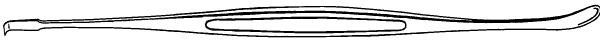

**21840-22** Howarth Elevator, double ended, 220mm

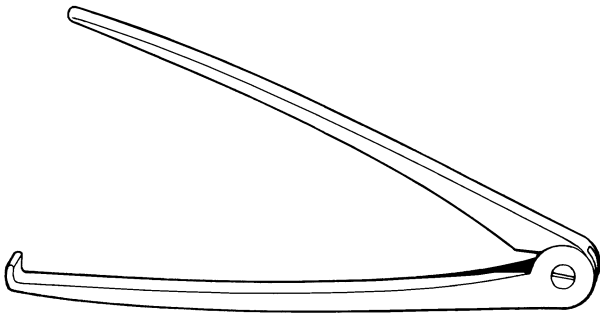

**21850-18** Kilner Malar Elevator, 180mm



**21853-21** Malar Elevator, for elevating the zygomatic arch and malar bone by intra-oral approach, 210mm

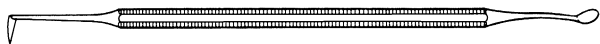

**21855-16** Mitchell Trimmer, double ended, 160mm

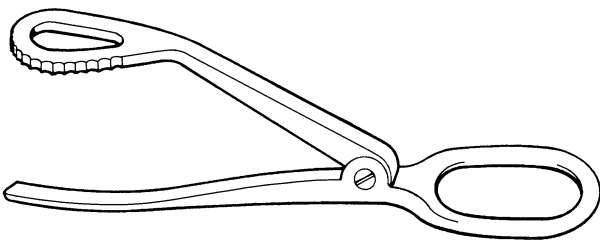

**21860-21** Rowe Zygomatic Elevator

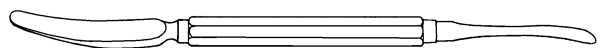

**21863-17** Roberts Periosteal Elevator, 170mm



**21865-15** Read Periosteal Elevator, single ended, blunt, 150mm



## Elevators

**21866-21** Read Periosteal Elevator, double ended, blunt, 215mm

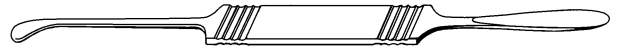

**21870-17** Syme Periosteal Elevator, double ended, 170mm

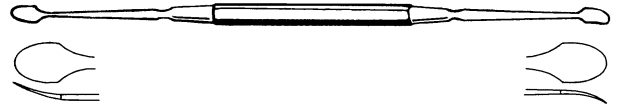

**21880-17** Ward Periosteal Elevator, fan shape, 170mm

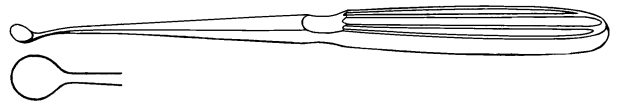

**21890-10** Warwick James Elevator, left



**21900-10** Warwick James Elevator, right



**21910-10** Warwick James Elevator, straight



## Files

**22000-17** Alveolectomy File, double ended, 170mm

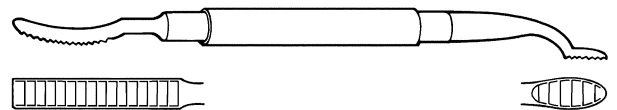

## Gouges

**22170-03** Coupland Gouge, 3mm

**22170-04** Coupland Gouge, 4mm

**22170-05** Coupland Gouge, 5mm

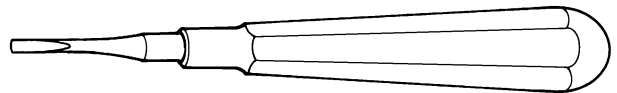

**22195-10** Parkes Hump Gouge, double guarded

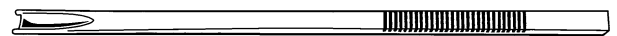

# Plastic and Maxillo Facial

## Gouges

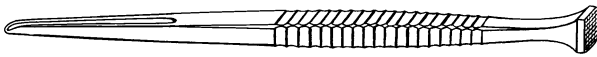

- 22200-02** Read Gouge, length 180mm, 2mm
- 22200-03** Read Gouge, length 180mm, 3mm
- 22200-04** Read Gouge, length 180mm, 4mm
- 22200-05** Read Gouge, length 180mm, 5mm
- 22200-06** Read Gouge, length 180mm, 6mm

## Hand Drills

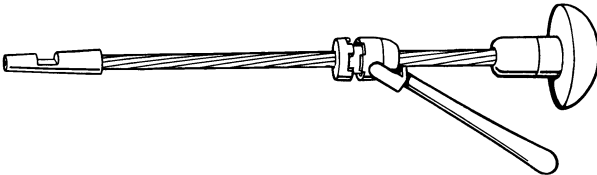

- 22300-19** Archimedean Hand Drill, 3mm fitting, 190mm

## Hooks



- 22380-15** Harrison Tendon Hook, 150mm

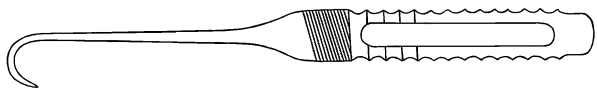

- 22400-21** Poswillo Malar Hook, 215mm

## Mallets

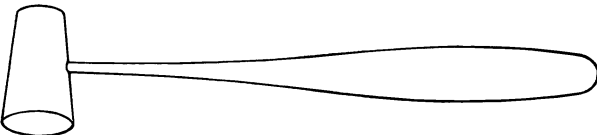

- 22500-06** Fickling Dental Mallet, s/s, 190mm, 25mm diameter, 190g (6.3/4oz)

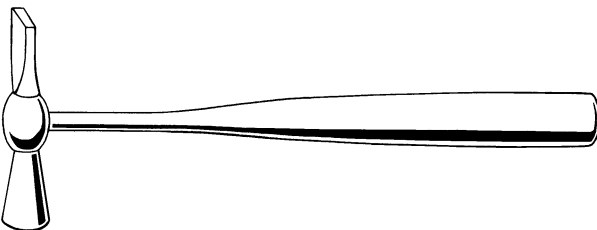

- 22505-11** Hammer For Hand Surgery, s/s, 195mm, 320g (11.1/4oz)

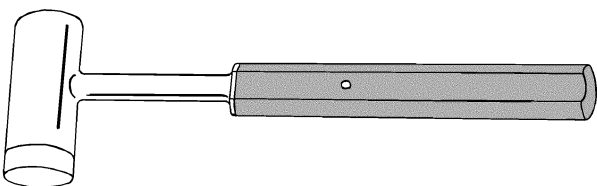

- 22508-17** Mallet For Ultra Fine Osteotome, s/s, nylon face insert, tufnol handle, 170mm, 20mm diameter, 145g (5oz)

## Mallets

**22510-12** Toffee Hammer, s/s, 340g (12oz)

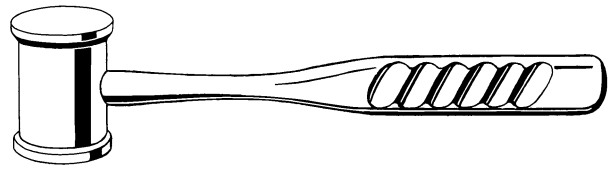

## Mapping Pens

**22600-14** Eckhoff Mapping Pen, complete, 145mm

**22600-50** Eckhoff Mapping Pen, spare nib

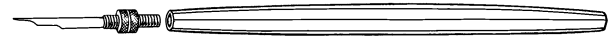

**22605-10** Galvao Nipple Marker, standard, 40mm diameter

**22605-50** Galvao Nipple Marker, large, 50mm diameter

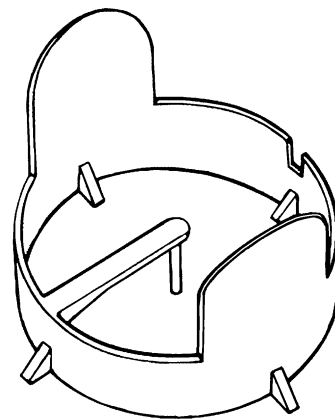

**22610-15** Sommerlad Pen, s/s, complete with adjustable tip, 150mm

**22610-50** Sommerlad Pen, s/s, nut only

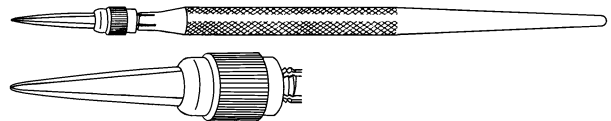

## Mouth Props

**22700-10** Rubber Mouth Prop, large

**22700-20** Rubber Mouth Prop, medium

**22700-30** Rubber Mouth Prop, small

**22700-90** Rubber Mouth Prop, complete set on chain

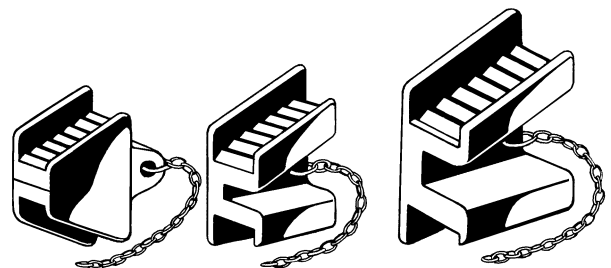

# Plastic and Maxillo Facial

## Nasal Saws

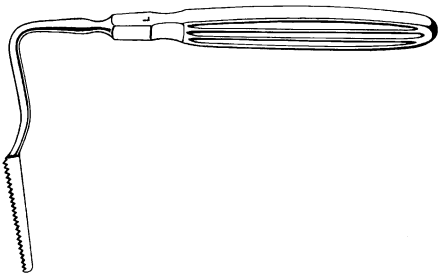

- 22800-12** Joseph Nasal Saw, horizontal shaft, 125mm x 85mm, cranked to the left
- 22810-12** Joseph Nasal Saw, horizontal shaft, 125mm x 85mm, cranked to the right



- 22820-18** Joseph Nasal Saw, straight, 180mm



- 22830-18** Joseph Nasal Saw, vertical shaft, 185mm, cranked to the left
- 22840-18** Joseph Nasal Saw, vertical shaft, 185mm, cranked to the right

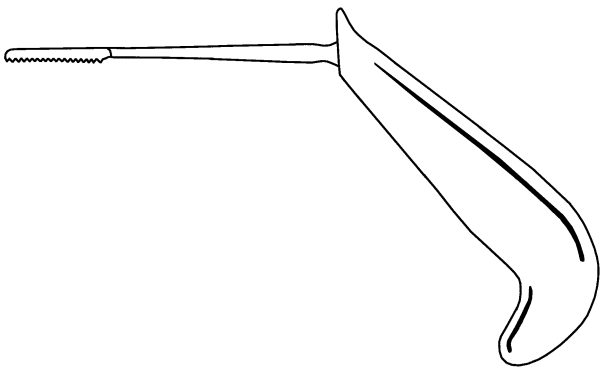

- 22860-20** Mowlem Nasal Saw, 200mm

## Needleholders

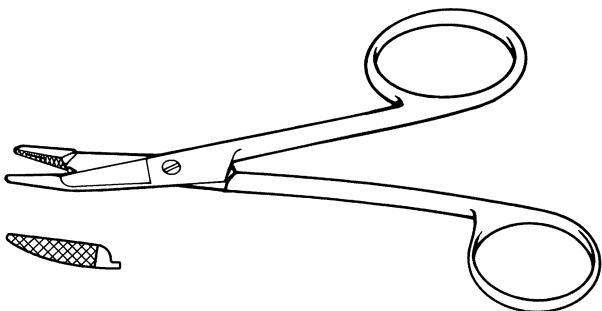

- 22900-12** Foster Gillies Needleholder, left hand, 130mm
- 22910-12** Foster Gillies Needleholder, right hand, 130mm

## Needleholders

- 22920-16** Gillies Needleholder, left hand, 165mm
- 22930-16** Gillies Needleholder, right hand, 165mm

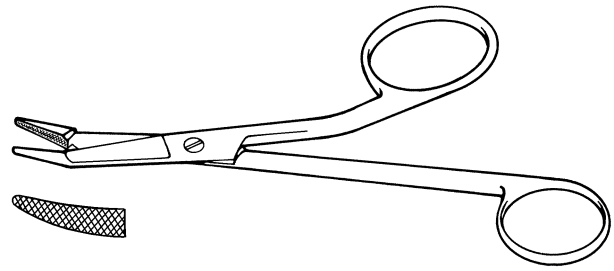

## Needleholders - Tungsten Carbide

- 23000-13** Foster Gillies Needleholder, tungsten carbide, left hand, 130mm
- 23010-13** Foster Gillies Needleholder, tungsten carbide, right hand, 130mm

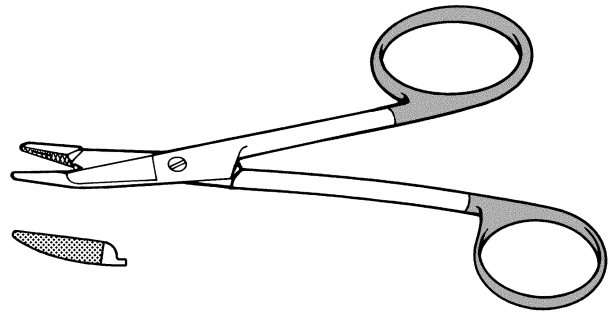

- 23020-16** Gillies Needleholder, tungsten carbide, left hand, 165mm
- 23030-16** Gillies Needleholder, tungsten carbide, right hand, 165mm

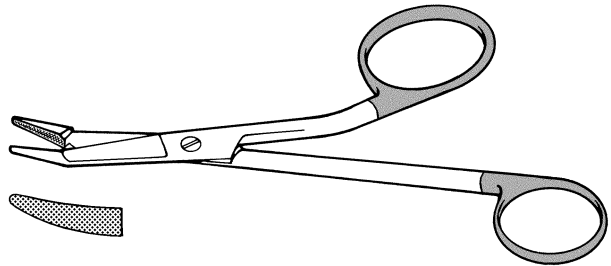

## Oral Forceps

- 23090-18** Fickling Oral Forcep, 1/2 teeth, 180mm
- 23091-18** Fickling Oral Forcep, serrated, 180mm

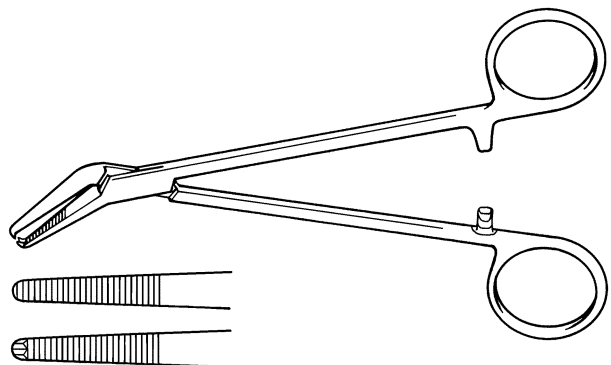

# Plastic and Maxillo Facial

## Oral Forceps

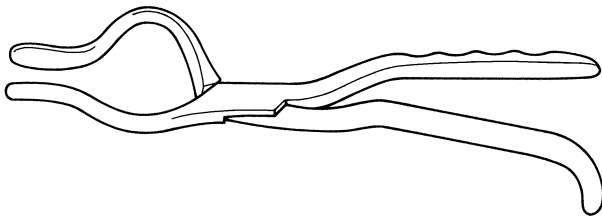

**23110-23** Rowe Disimpaction Oral Forcep, left, screw joint, 230mm

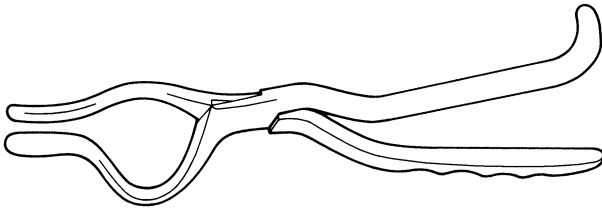

**23120-23** Rowe Disimpaction Oral Forcep, right, screw joint, 230mm

## Osteotomes

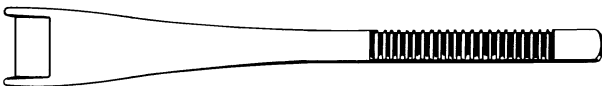

- 23180-10** Cinelli Osteotome, double guarded, 10mm
- 23180-12** Cinelli Osteotome, double guarded, 12mm
- 23180-14** Cinelli Osteotome, double guarded, 14mm
- 23180-16** Cinelli Osteotome, double guarded, 16mm

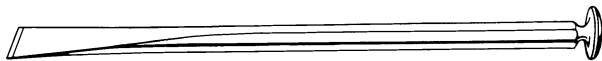

- 23200-02** French (Gillies) Osteotome, length 140mm, 2mm
- 23200-03** French (Gillies) Osteotome, length 140mm, 3mm
- 23200-04** French (Gillies) Osteotome, length 140mm, 4mm
- 23200-05** French (Gillies) Osteotome, length 140mm, 5mm
- 23200-06** French (Gillies) Osteotome, length 140mm, 6mm
- 23200-07** French (Gillies) Osteotome, length 140mm, 7mm
- 23200-08** French (Gillies) Osteotome, length 140mm, 8mm
- 23200-09** French (Gillies) Osteotome, length 140mm, 9mm
- 23200-10** French (Gillies) Osteotome, length 140mm, 10mm
- 23200-11** French (Gillies) Osteotome, length 140mm, 11mm
- 23200-12** French (Gillies) Osteotome, length 140mm, 12mm
- 23200-13** French (Gillies) Osteotome, length 140mm, 13mm

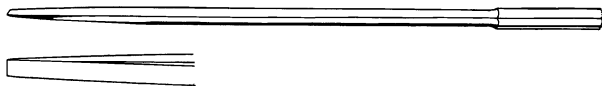

- 23210-02** Jayes Osteotome, 2mm
- 23210-04** Jayes Osteotome, 4mm
- 23210-05** Jayes Osteotome, 5mm
- 23210-07** Jayes Osteotome, 7mm
- 23210-10** Jayes Osteotome, 10mm
- 23210-12** Jayes Osteotome, 12mm
- 23210-15** Jayes Osteotome, 15mm

- 23215-11** MacGregor Nasal Osteotome, bevelled corners, flat handle with mushroom head, 11mm
- 23215-13** MacGregor Nasal Osteotome, bevelled corners, flat handle with mushroom head, 13mm
- 23215-15** MacGregor Nasal Osteotome, bevelled corners, flat handle with mushroom head, 15mm

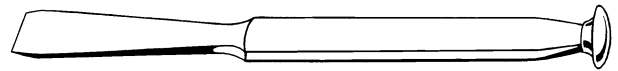

- 23220-11** Matthew Osteotome, bevelled at one corner, 11mm

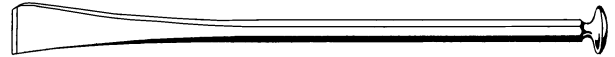

- 23226-10** Neivert Osteotome, single guarded, left, 3.5mm
- 23226-20** Neivert Osteotome, single guarded, right, 3.5mm
- 23226-30** Neivert Osteotome, single guarded, straight, 3.5mm

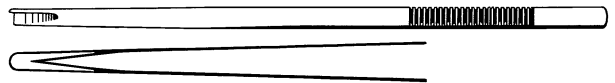

- 23230-02** Read Osteotome, length 180mm, 2mm
- 23230-03** Read Osteotome, length 180mm, 3mm
- 23230-04** Read Osteotome, length 180mm, 4mm
- 23230-05** Read Osteotome, length 180mm, 5mm
- 23230-06** Read Osteotome, length 180mm, 6mm

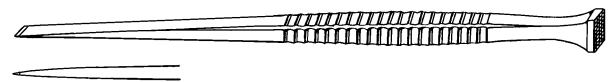

- 23240-10** Rozner Osteotome, probe point on each side of inclined cutting edge

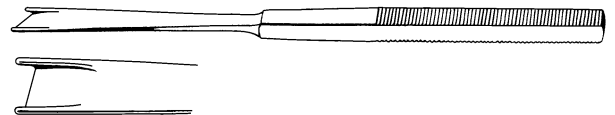

# Plastic and Maxillo Facial

## Osteotomes

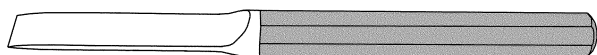

- 23243-10** Ultra Fine Osteotome, case only
- 23243-20** Ultra Fine Osteotome, rack only, to take 1 x mallet and 6 x osteotomes
- 23243-90** Ultra Fine Osteotome, case and rack, complete, to take 1 x mallet and 6 x osteotomes
- 23244-02** Ultra Fine Osteotome, TiN coated blade, tufnol handle, 140mm, 2mm
- 23244-04** Ultra Fine Osteotome, TiN coated blade, tufnol handle, 140mm, 4mm
- 23244-06** Ultra Fine Osteotome, TiN coated blade, tufnol handle, 140mm, 6mm
- 23244-08** Ultra Fine Osteotome, TiN coated blade, tufnol handle, 140mm, 8mm
- 23244-10** Ultra Fine Osteotome, TiN coated blade, tufnol handle, 140mm, 10mm
- 23244-12** Ultra Fine Osteotome, TiN coated blade, tufnol handle, 140mm, 12mm
- 23244-90** Ultra Fine Osteotome, TiN coated blade, tufnol handle, 140mm, set of 6 (2mm to 12mm)
- 23245-02** Ultra Fine Osteotome, TiN coated blade, tufnol handle, 160mm, 2mm
- 23245-04** Ultra Fine Osteotome, TiN coated blade, tufnol handle, 160mm, 4mm
- 23245-06** Ultra Fine Osteotome, TiN coated blade, tufnol handle, 160mm, 6mm
- 23245-08** Ultra Fine Osteotome, TiN coated blade, tufnol handle, 160mm, 8mm
- 23245-10** Ultra Fine Osteotome, TiN coated blade, tufnol handle, 160mm, 10mm
- 23245-12** Ultra Fine Osteotome, TiN coated blade, tufnol handle, 160mm, 12mm
- 23245-90** Ultra Fine Osteotome, TiN coated blade, tufnol handle, 160mm, set of 6 (2mm to 12mm)



- 23250-03** Ward Osteotome, length 180mm, 3mm
- 23250-04** Ward Osteotome, length 180mm, 4mm
- 23250-05** Ward Osteotome, length 180mm, 5mm

## Raspatories



- 23300-10** Cleft Palate Raspatory, curved downwards
- 23310-10** Cleft Palate Raspatory, curved upwards



- 23320-10** Cleft Palate Raspatory, curved upwards, left



- 23330-10** Cleft Palate Raspatory, curved upwards, right



## Raspatories

- 23350-10** Joseph Nasal Raspatory, curved  
**23360-10** Joseph Nasal Raspatory, straight



## Rasps

- 23400-10** Barsky Glabella Rasp, curved, reverse cutting teeth, concave surface

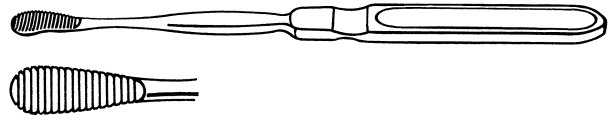

- 23410-10** Barsky Nasal Rasp, straight, reverse cutting teeth, concave surface

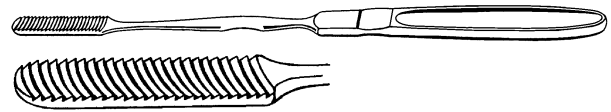

- 23435-17** Maltz Nasal Rasp, straight, with longitudinal serrations, 170mm

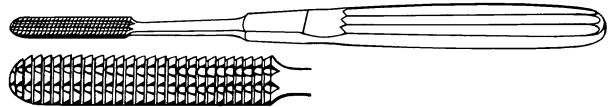

- 23440-19** Maltz Nasal Rasp, curved, deep cut serrations, 190mm  
**23450-17** Maltz Nasal Rasp, straight, deep cut serrations, 175mm

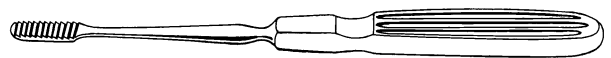

- 23455-17** McIndoe Nasal Rasp, straight, reverse cutting teeth, 170mm

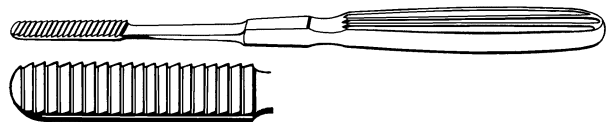

- 23460-19** Reidy Nasal Rasp, curved, cross serrated, 195mm

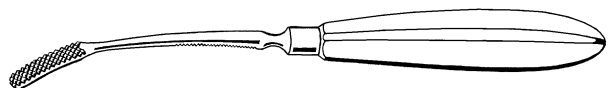

# Plastic and Maxillo Facial

## Reamers



- 23490-02** Harrison Nicholl Reamer, s/s, double ended, malleable, size 1/2
- 23490-04** Harrison Nicholl Reamer, s/s, double ended, malleable, size 3/4
- 23490-06** Harrison Nicholl Reamer, s/s, double ended, malleable, size 5/6
- 23490-08** Harrison Nicholl Reamer, s/s, double ended, malleable, size 7/8
- 23490-10** Harrison Nicholl Reamer, s/s, double ended, malleable, size 9/10
- 23490-12** Harrison Nicholl Reamer, s/s, double ended, malleable, size 11/12
- 23490-14** Harrison Nicholl Reamer, s/s, double ended, malleable, size 13/14
- 23490-90** Harrison Nicholl Reamer, s/s, double ended, malleable, set of 7 sizes (1/2 - 13/14)

## Retractors

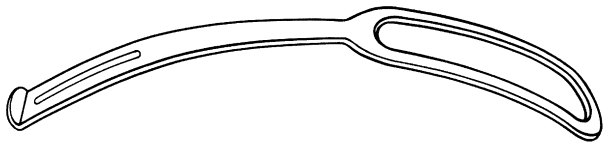

- 23500-12** Awty Osteotomy Retractor, 12mm wide, pair
- 23500-17** Awty Osteotomy Retractor, 17mm wide, pair

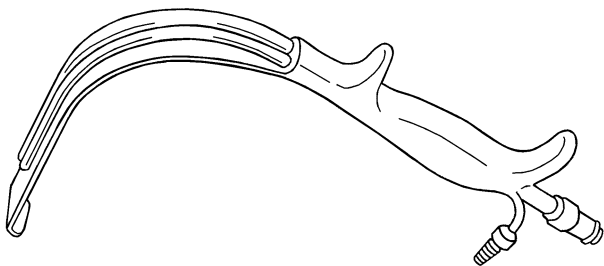

- 23505-25** Attwood Retractor, with through handle fibrelight and suction tube, 2mm thick blade, 110mm deep x 25mm wide
- 23505-40** Attwood Retractor, with through handle fibrelight and suction tube, 2mm thick blade, 150mm deep x 40mm wide
- 23505-50** Attwood Retractor, with through handle fibrelight and suction tube, 2mm thick blade, 190mm deep x 50mm wide

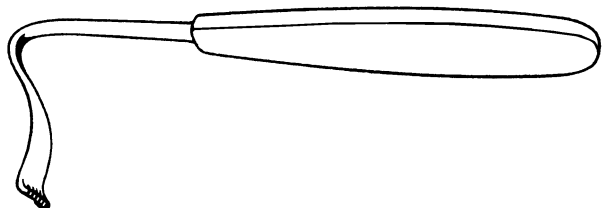

- 23510-19** Bowdler-Henry (Monks Tissue) Rake Retractor, 170mm

**23515-25** Converse Retractor, with fibreight, 25mm deep x 12mm wide

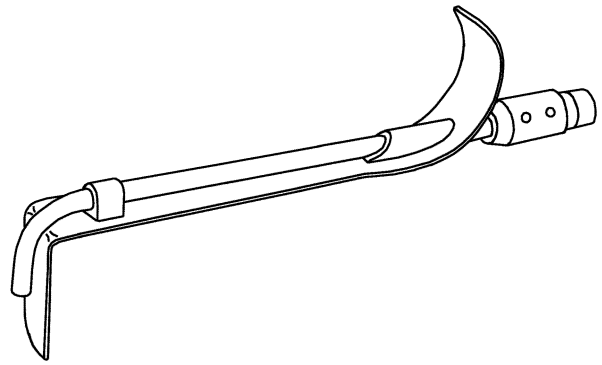

**23520-10** Cottle Upper Lateral Exposing Retractor

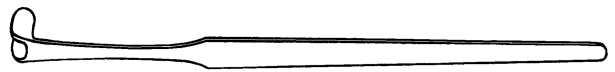

**23530-08** Desmarres Retractor, tight curve, 140mm, 8mm wide

**23530-12** Desmarres Retractor, tight curve, 140mm, 12mm wide

**23530-14** Desmarres Retractor, tight curve, 140mm, 14mm wide

**23530-16** Desmarres Retractor, tight curve, 140mm, 16mm wide

**23530-18** Desmarres Retractor, tight curve, 140mm, 18mm wide

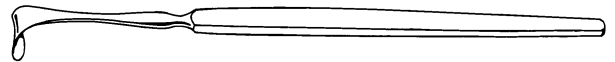

**23532-30** Eddey Parotid Retractor, dished blade, serrated, 30mm deep x 20mm wide blade

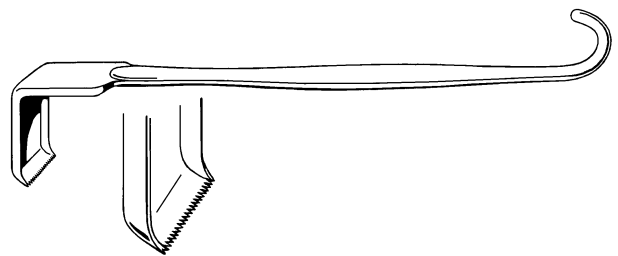

**23534-17** Fitzpatrick Mandibular 'Trowel' Retractor, 170mm

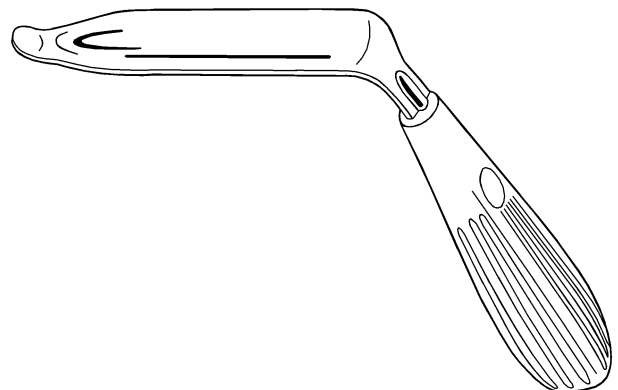

# Plastic and Maxillo Facial

## Retractors

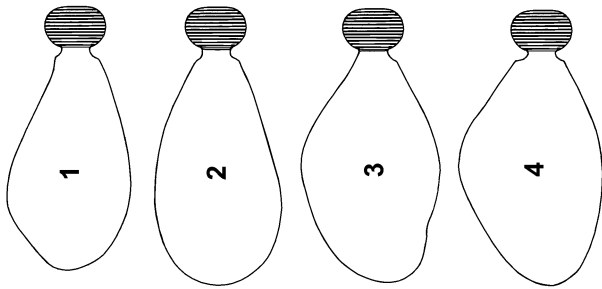

- 23536-10** Fitzpatrick Tongue Guard Retractor, malleable, No.1, 84mm, suitable for small mouth or child
- 23536-20** Fitzpatrick Tongue Guard Retractor, malleable, No.2, 88mm, universal, does not need reshaping for opposite sides of the mouth
- 23536-30** Fitzpatrick Tongue Guard Retractor, malleable, No.3, 86mm, a variation in contour for No.2
- 23536-40** Fitzpatrick Tongue Guard Retractor, malleable, No.4, 88mm, suitable for large or edentulous mouth
- 23536-90** Fitzpatrick Tongue Guard Retractor, malleable, set of 4

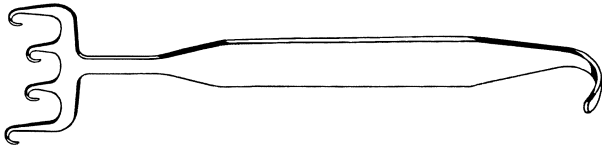

- 23538-18** Freeman Face Lift Retractor, 185mm

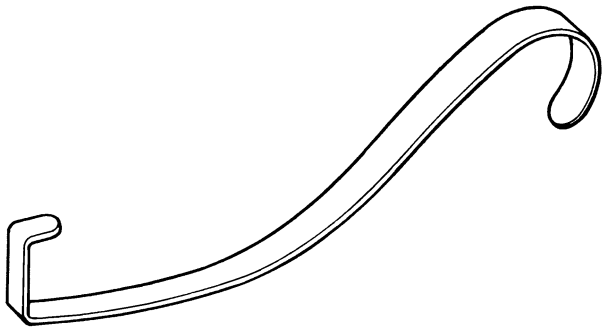

- 23540-16** Hajeck Retractor, for upper lip, 165mm

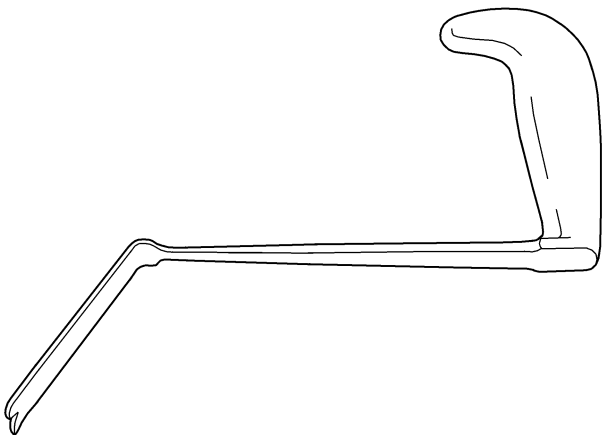

- 23545-15** Henderson Stripping Retractor, for ramus, 150mm

- 23547-16** Intra Oral Vertical Osteotomy Retractor, with through handle fibrelight, 100mm deep x 16mm wide

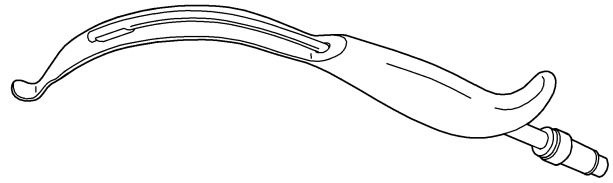

- 23550-14** Kay Austin Retractor, 140mm

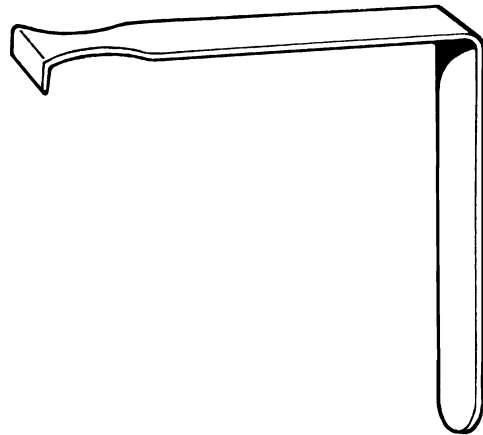

- 23560-15** Kilner 'Cats Paw' Retractor, double ended, 150mm

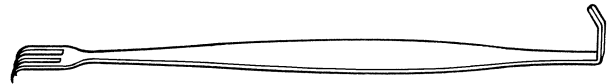

- 23565-25** Hurren Retractor, with through handle fibrelight, 60 deg blade angle, without lip, 150mm deep x 25mm wide

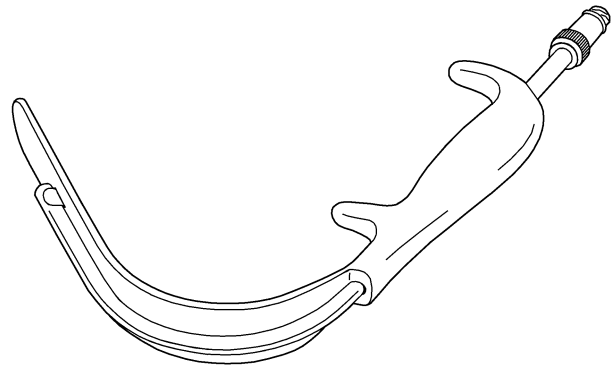

- 23570-10** Kilner Alae Retractor, blunt, 85mm x 10mm  
**23570-13** Kilner Alae Retractor, blunt, 85mm x 13mm  
**23570-15** Kilner Alae Retractor, blunt, 85mm x 15mm  
**23580-10** Kilner Alae Retractor, sharp, 85mm x 10mm  
**23580-13** Kilner Alae Retractor, sharp, 85mm x 13mm  
**23580-15** Kilner Alae Retractor, sharp, 85mm x 15mm

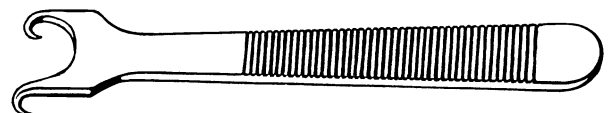

# Plastic and Maxillo Facial

## Retractors

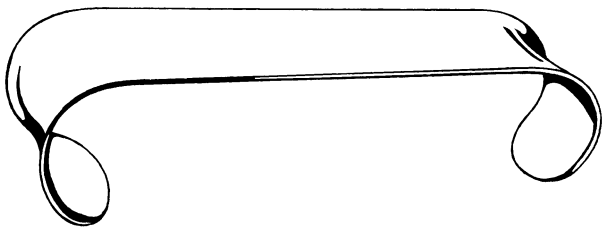

- 23590-18** Kilner Cheek Retractor, double ended, 25mm x 18mm
- 23590-22** Kilner Cheek Retractor, double ended, 25mm x 22mm
- 23590-27** Kilner Cheek Retractor, double ended, 35mm x 27mm
- 23590-28** Kilner Cheek Retractor, double ended, 30mm x 28mm
- 23600-18** Kilner Cheek Retractor, double ended, insulated, 25mm x 18mm
- 23600-22** Kilner Cheek Retractor, double ended, insulated, 25mm x 22mm
- 23600-27** Kilner Cheek Retractor, double ended, insulated, 35mm x 27mm
- 23600-28** Kilner Cheek Retractor, double ended, insulated, 30mm x 28mm

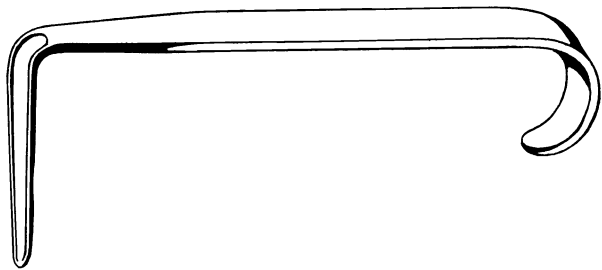

- 23610-15** Kilner Nasal Retractor, 150mm

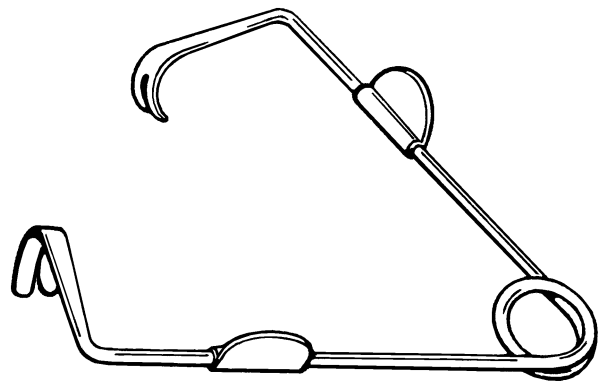

- 23611-05** Kilner Skin Retractor, long teeth, 50mm

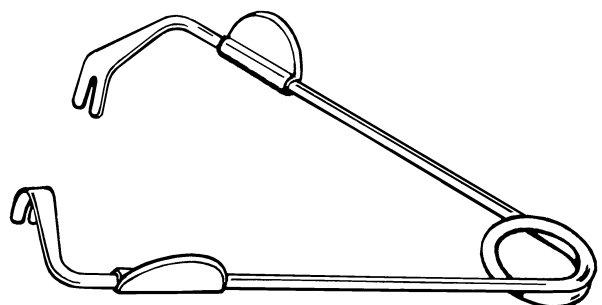

- 23611-06** Kilner Skin Retractor, small teeth, 60mm

- 23612-25** Mammary Retractor, with through handle fibrelight and suction tube, plain lip, 90mm deep x 25mm wide
- 23615-25** Mammary Retractor, with through handle fibrelight and suction tube, toothed lip, 150mm deep x 25mm wide, 5 teeth, semi-sharp
- 23615-32** Mammary Retractor, with through handle fibrelight and suction tube, toothed lip, 150mm deep x 32mm wide, 6 teeth, semi-sharp
- 23615-40** Mammary Retractor, with through handle fibrelight and suction tube, toothed lip, 150mm deep x 40mm wide, 8 teeth, semi-sharp
- 23616-25** Mammary Retractor, with through handle fibrelight and suction tube, plain lip, 150mm deep x 25mm wide
- 23616-40** Mammary Retractor, with through handle fibrelight and suction tube, plain lip, 150mm deep x 40mm wide
- 23617-25** Mammary Retractor, with through handle fibrelight and suction tube, toothed lip, 190mm deep x 25mm wide, 5 teeth, semi-sharp
- 23618-25** Mammary Retractor, with through handle fibrelight and suction tube, plain lip, 190mm deep x 25mm wide
- 23623-25** Mammary Retractor, with through handle fibrelight and suction tube, plain lip, 110mm deep x 25mm wide
- 23623-40** Mammary Retractor, with through handle fibrelight and suction tube, plain lip, 110mm deep x 40mm wide

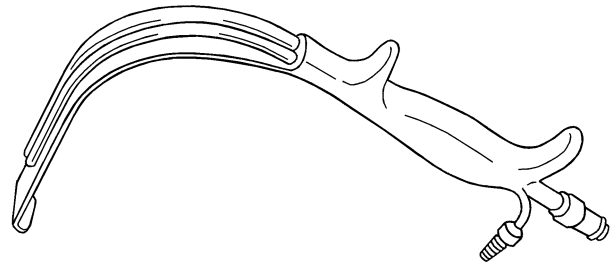

- 
- 23634-25** Mammary Retractor, with through handle fibrelight, without lip, 150mm deep x 25mm wide
  - 23639-40** Mammary Retractor, with through handle fibrelight, without lip, 190mm deep x 40mm wide
  - 23639-50** Mammary Retractor, with through handle fibrelight, without lip, 190mm deep x 50mm wide
  - 23644-25** Mammary Retractor, with through handle fibrelight, without lip, 110mm deep x 25mm wide

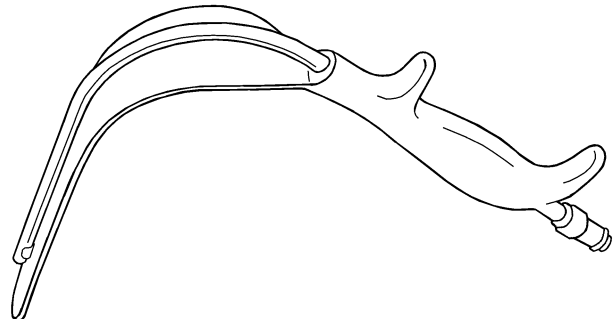

## Retractors

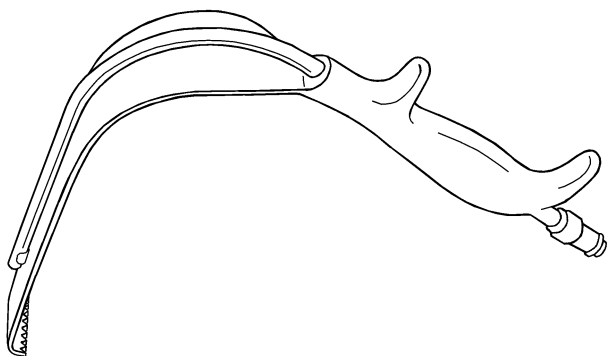

- 23631-25** Mammary Retractor, with through handle fibrelight, toothed lip, 90mm deep x 25mm wide, 5 teeth, semi-sharp
- 23631-40** Mammary Retractor, with through handle fibrelight, toothed lip, 90mm deep x 40mm wide, 8 teeth, semi-sharp
- 23635-25** Mammary Retractor, with through handle fibrelight, toothed lip, 150mm deep x 25mm wide, 5 teeth, semi-sharp
- 23635-40** Mammary Retractor, with through handle fibrelight, toothed lip, 150mm deep x 40mm wide, 8 teeth, semi-sharp
- 23637-25** Mammary Retractor, with through handle fibrelight, toothed lip, 190mm deep x 25mm wide, 5 teeth, semi-sharp
- 23637-40** Mammary Retractor, with through handle fibrelight, toothed lip, 190mm deep x 40mm wide, 8 teeth, semi-sharp
- 23642-25** Mammary Retractor, with through handle fibrelight, toothed lip, 110mm deep x 25mm wide, 5 teeth, semi-sharp
- 23642-40** Mammary Retractor, with through handle fibrelight, toothed lip, 110mm deep x 40mm wide, 8 teeth, semi-sharp
- 23642-44** Mammary Retractor, with through handle fibrelight, toothed lip, 110mm deep x 44mm wide, 9 teeth, semi-sharp

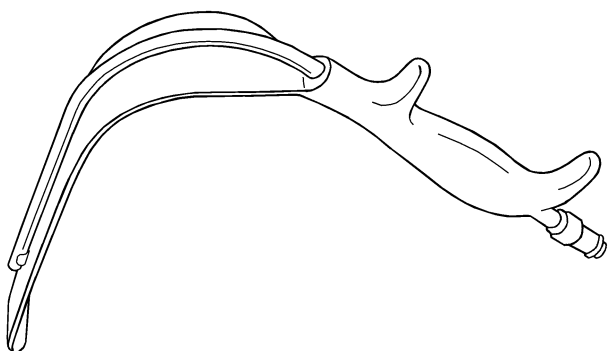

- 23632-25** Mammary Retractor, with through handle fibrelight, plain lip, 90mm deep x 25mm wide
- 23632-40** Mammary Retractor, with through handle fibrelight, plain lip, 90mm deep x 40mm wide
- 23636-25** Mammary Retractor, with through handle fibrelight, plain lip, 150mm deep x 25mm wide
- 23636-40** Mammary Retractor, with through handle fibrelight, plain lip, 150mm deep x 40mm wide
- 23638-25** Mammary Retractor, with through handle fibrelight, plain lip, 190mm deep x 25mm wide
- 23638-40** Mammary Retractor, with through handle fibrelight, plain lip, 190mm deep x 40mm wide
- 23643-25** Mammary Retractor, with through handle fibrelight, plain lip, 110mm deep x 25mm wide
- 23643-40** Mammary Retractor, with through handle fibrelight, plain lip, 110mm deep x 40mm wide
- 23643-44** Mammary Retractor, with through handle fibrelight, plain lip, 110mm deep x 44mm wide

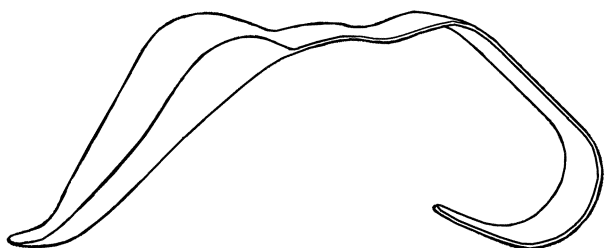

- 23640-10** Laster Cheek Retractor, for third upper molar, enables a chisel to be held, 100mm



**23648-13** McIndoe Retractor, temporo-mandibular, 13mm wide x 25mm deep



**23650-44** Oringer Cheek And Lip Retractor, size 1, 44mm deep

**23650-51** Oringer Cheek And Lip Retractor, size 2, 51mm deep

**23650-57** Oringer Cheek And Lip Retractor, size 3, 57mm deep



**23655-10** Mustarde Offset Orbital Retractor, central, 110mm

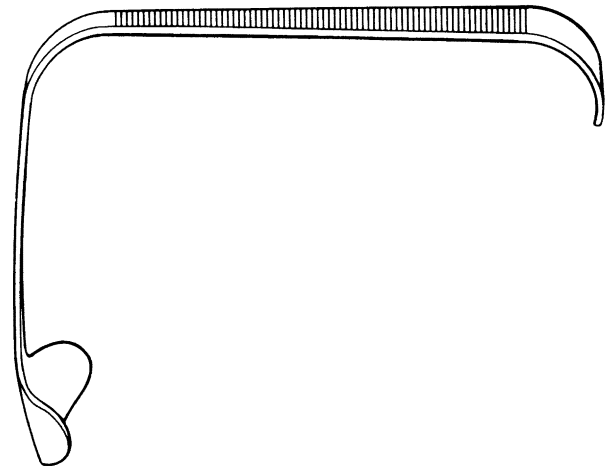

**23655-20** Mustarde Offset Orbital Retractor, deep right, 110mm

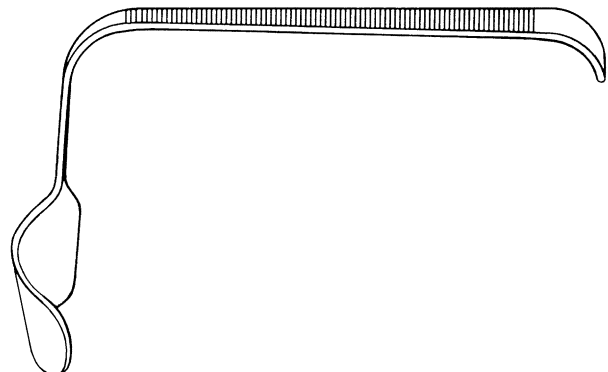

# Plastic and Maxillo Facial

## Retractors

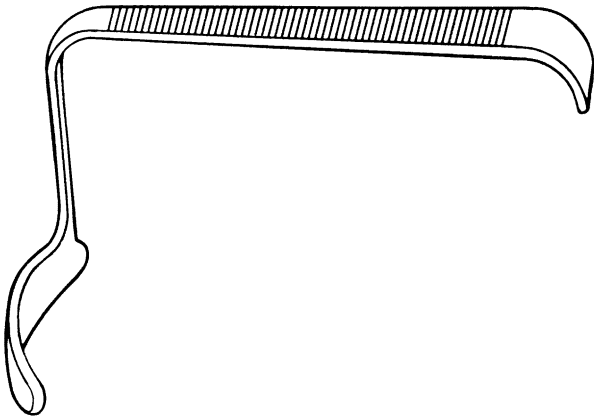

**23655-30** Mustarde Offset Orbital Retractor, shallow right, 110mm

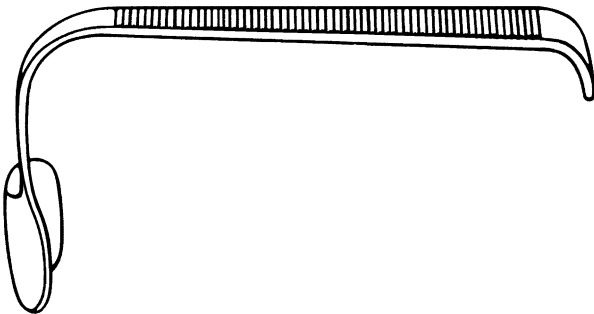

**23655-40** Mustarde Offset Orbital Retractor, deep left, 110mm

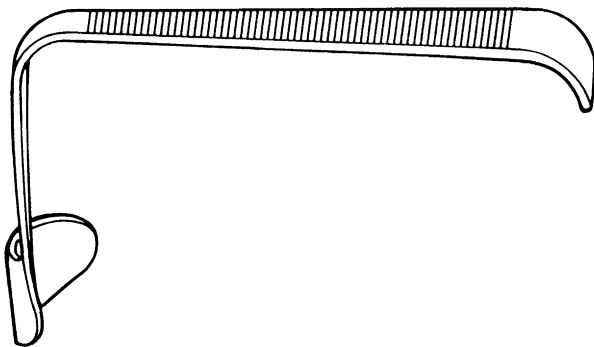

**23655-50** Mustarde Offset Orbital Retractor, shallow left, 110mm

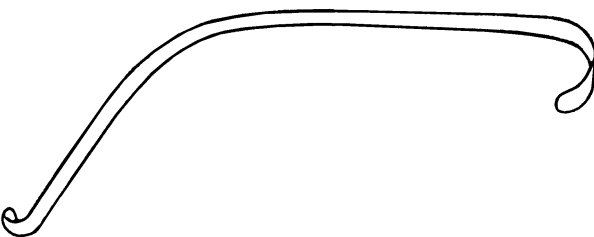

**23660-17** Prognathism Channel Retractor, 170mm

**23670-10** Rayne Mandibular Retractor, hollow handle

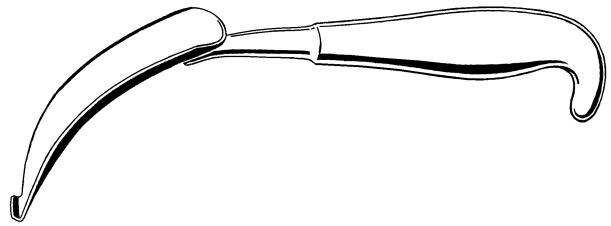

**23680-21** Rowe Buccal Retractor, double ended, curved to the left, 215mm

**23690-21** Rowe Buccal Retractor, double ended, curved to the right, 215mm

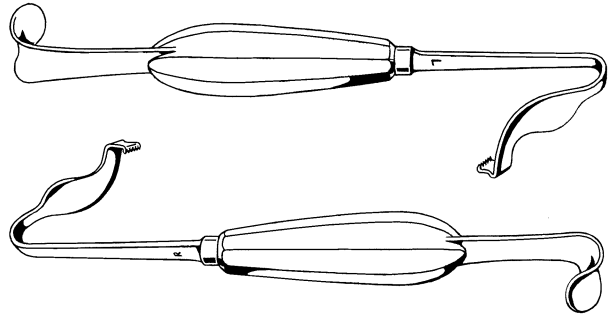

**23700-25** Rowe Lingual Retractor, double ended, curved to the left, 250mm

**23710-25** Rowe Lingual Retractor, double ended, curved to the right, 250mm

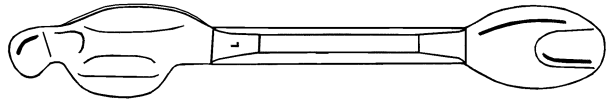

**23720-10** Rowe Maxillary Labial Flap Retractor, double ended, serrated edge blades

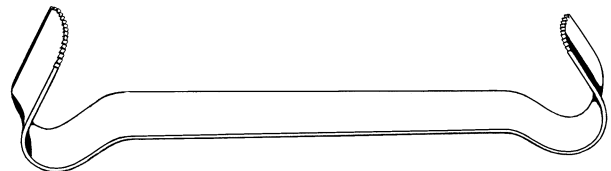

**23725-19** Seward Retractor, double ended, rectangular blades, 19mm x 10mm, 130mm, pair

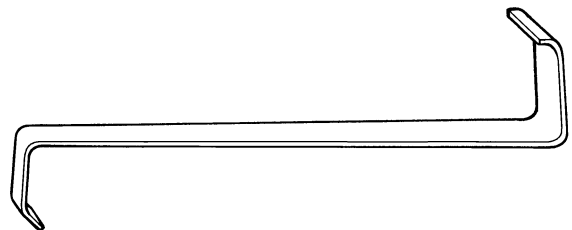

# Plastic and Maxillo Facial

## Retractors

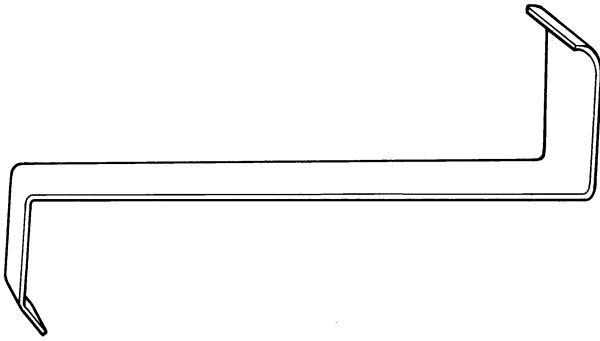

**23725-25** Seward Retractor, double ended, rectangular blades, 25mm x 13mm, 140mm, pair

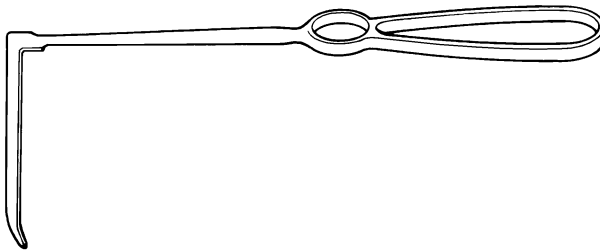

**23730-22** Maxilla Stripping Retractor, 220mm

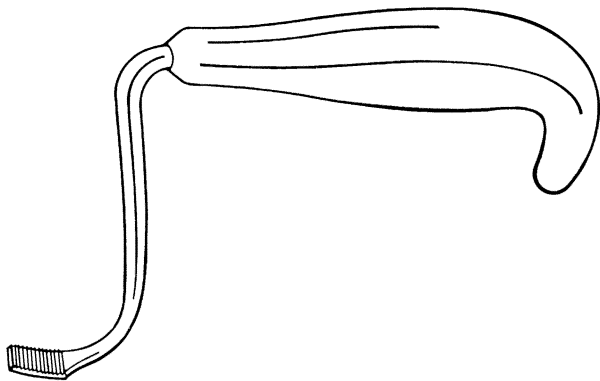

**23732-10** Tessier Maxillary Mobiliser, left, 160mm x 100mm

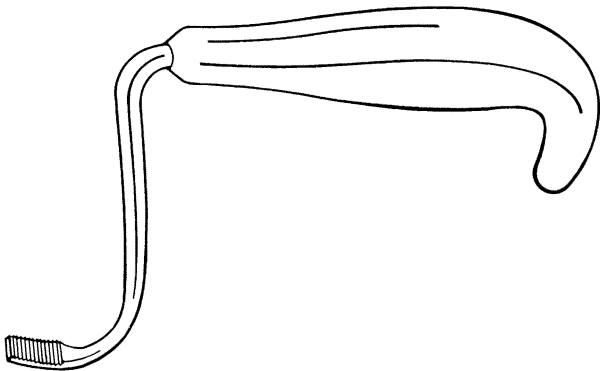

**23732-20** Tessier Maxillary Mobiliser, right, 160mm x 100mm

**23735-18** Thexton Tongue And Flap Retractor, 180mm

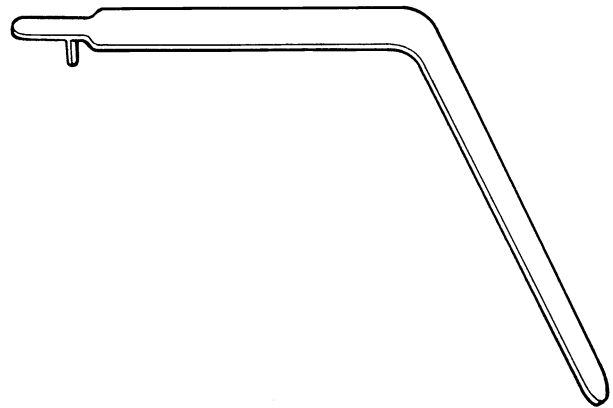

**23740-15** Ward Cheek Retractor, double ended, 150mm

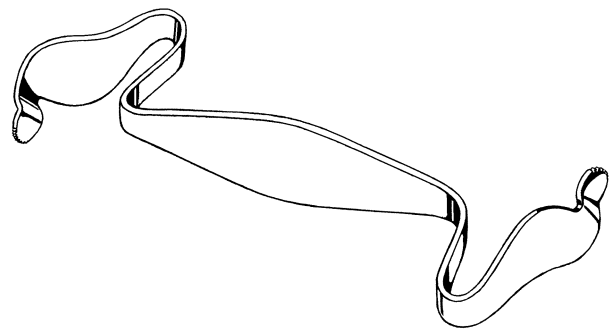

**23750-19** Whitlock Lingual Retractor, 190mm

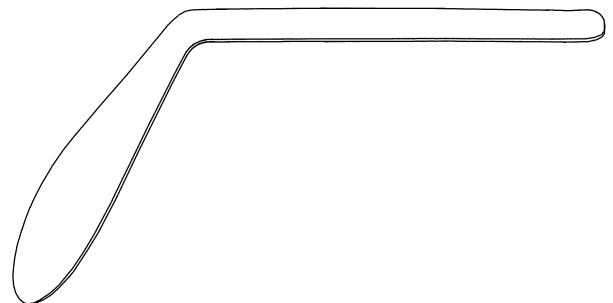

## Scalpel Handles

**23900-03** Barron Scalpel Handle, octagonal, No.3, 130mm

**23900-04** Barron Scalpel Handle, octagonal, No.4, 130mm

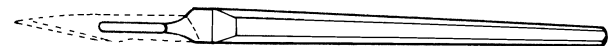

# Plastic and Maxillo Facial

## Scissors

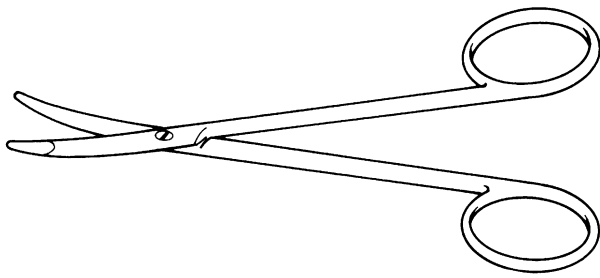

24000-11 Kilner Scissor, curved, blunt points, 110mm

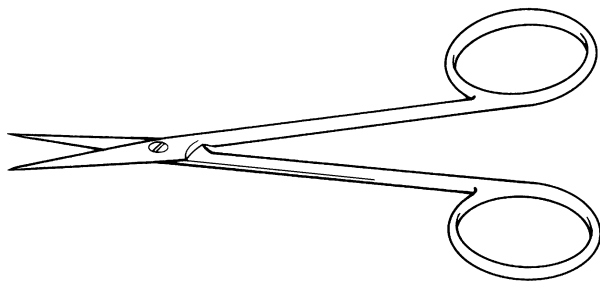

24010-11 Kilner Scissor, straight, sharp points, rounded blades, 110mm

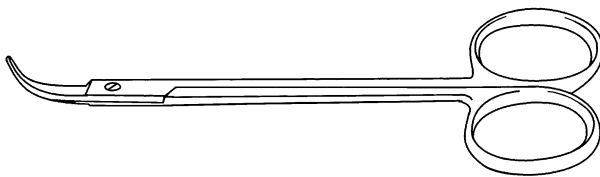

24020-11 Alar Cartilage Scissor, curved on flat, 110mm

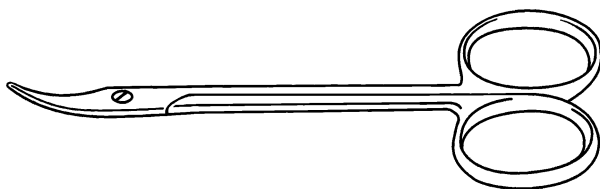

24030-10 Campbell Suture Scissor, curved, needle points, 100mm

## Septum Forceps

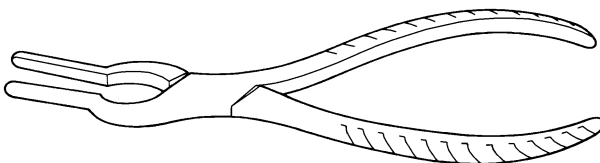

24100-23 Asch Septum Forcep, 235mm

## Septum Forceps

**24105-18** Jansen-Middleton Septum Forcep, double action, 185mm

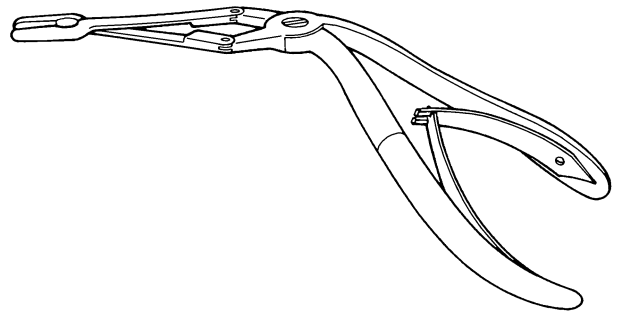

**24110-22** Walsham Septum Forcep, redressing, left, 220mm



**24120-22** Walsham Septum Forcep, redressing, right, 220mm



**24130-19** Walsham Septum Forcep, straight, 190mm

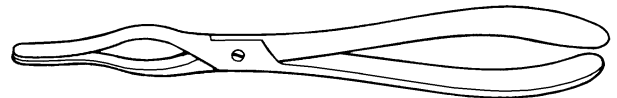

## Skin Graft Boards

**24200-10** Gabarro Skin Graft Measurer

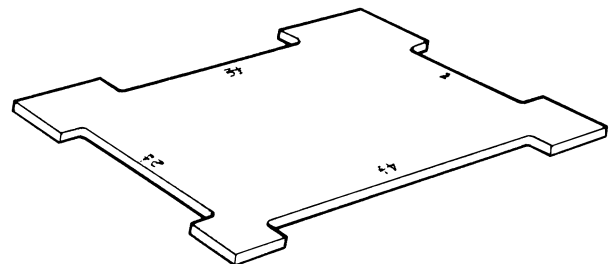

**24205-10** Gibson-Ross Skin Graft Board, 100mm x 100mm

**24205-12** Gibson-Ross Skin Graft Board, 100mm x 125mm

**24205-18** Gibson-Ross Skin Graft Board, 100mm x 180mm

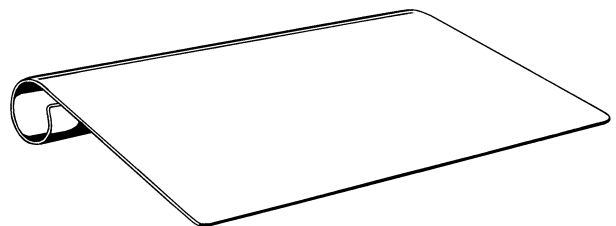

# Plastic and Maxillo Facial

## Skin Graft Boards

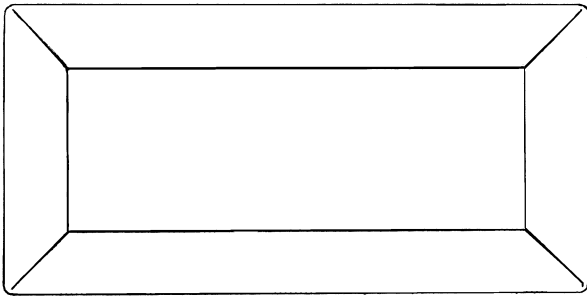

**24210-20** Tufnol Skin Graft Board, bevelled edge, 200mm x 100mm

## Skin Graft Knives

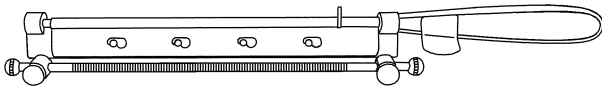

**24295-15** Humby Skin Graft Knife, right handed, 365mm  
**24295-25** Humby Skin Graft Knife, left handed, 365mm

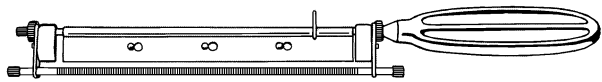

**24300-15** Braithwaite Skin Graft Knife, s/s, right handed, 305mm  
**24300-25** Braithwaite Skin Graft Knife, s/s, left handed, 305mm

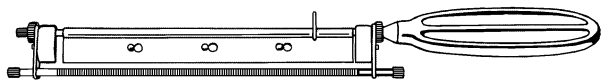

**24310-15** Cobbett Skin Graft Knife, s/s, right handed, 305mm  
**24310-25** Cobbett Skin Graft Knife, s/s, left handed, 305mm

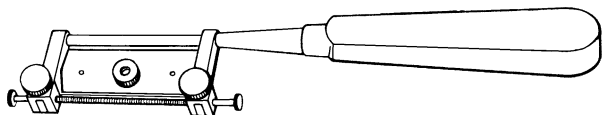

**24320-15** Silver Skin Graft Knife, s/s, right handed, 190mm  
**24320-25** Silver Skin Graft Knife, s/s, left handed, 190mm

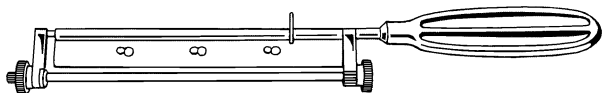

**24330-15** Watson Skin Graft Knife, s/s, right handed, 305mm  
**24330-25** Watson Skin Graft Knife, s/s, left handed, 305mm

## Skin Hooks



**24400-15** Barsky Double Skin Hook, complete, 150mm  
**24400-50** Barsky Double Skin Hook, hook only



- 24405-02** Gillies Skin Hook, knurled handle, 185mm, fine, 2mm
- 24405-03** Gillies Skin Hook, knurled handle, 185mm, standard, 3mm
- 24405-04** Gillies Skin Hook, knurled handle, 185mm, large, 4mm

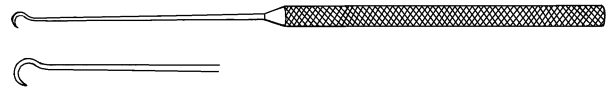

- 24410-18** Gillies Skin Hook, plain handle, 185mm, large, 4mm
- 24420-18** Gillies Skin Hook, plain handle, 185mm, standard, 3mm
- 24422-18** Gillies Skin Hook, plain handle, 185mm, fine, 2mm



- 24425-03** Gordon Skin Hook, complete with chain and 55g (2oz) weight, 120mm



- 24427-11** Humby Double Skin Hook, hinged, 115mm

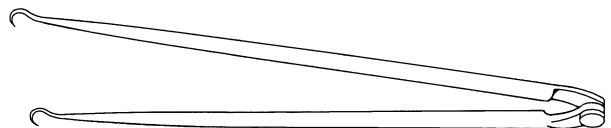

- 24430-50** Kilner Detachable Skin Hook, hook only, extra fine, 2mm
- 24430-90** Kilner Detachable Skin Hook, complete, extra fine, 2mm
- 24440-50** Kilner Detachable Skin Hook, hook only, fine, 3mm
- 24440-90** Kilner Detachable Skin Hook, complete, fine, 3mm
- 24450-50** Kilner Detachable Skin Hook, hook only, standard, 4mm
- 24450-90** Kilner Detachable Skin Hook, complete, standard, 4mm
- 24460-10** Kilner Detachable Skin Hook, handle only

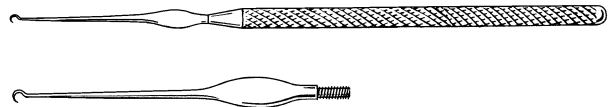

- 24445-50** Kilner Detachable Skin Hook, hook only, fine, straight, 3mm
- 24445-90** Kilner Detachable Skin Hook, complete, fine, straight, 3mm

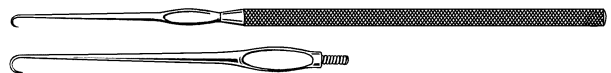

# Plastic and Maxillo Facial

## Skin Hooks



- 24470-09 McIndoe Double Skin Hook, length 150mm, 9mm
- 24470-10 McIndoe Double Skin Hook, length 150mm, 10mm
- 24470-11 McIndoe Double Skin Hook, length 150mm, 11mm



- 24480-19 McIndoe Single Skin Hook, 190mm

## Suction Tubes

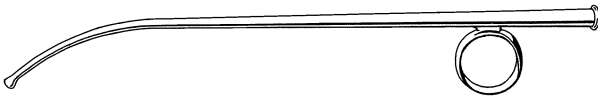

- 24490-19 Kilner Suction Tube, s/s, 190mm

## Suture Pushers



- 24500-24 Bateman Suture Pusher, 240mm

## Syringes

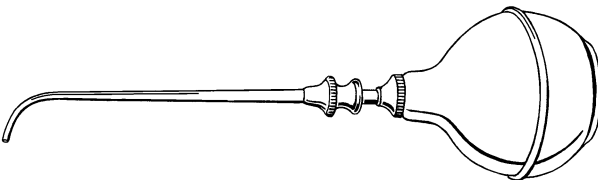

- 24550-50 Dental Chip Syringe, nozzle only
- 24550-60 Dental Chip Syringe, rubber bulb only
- 24550-90 Dental Chip Syringe, complete, nozzle and rubber bulb, 180mm

## Traction Bows

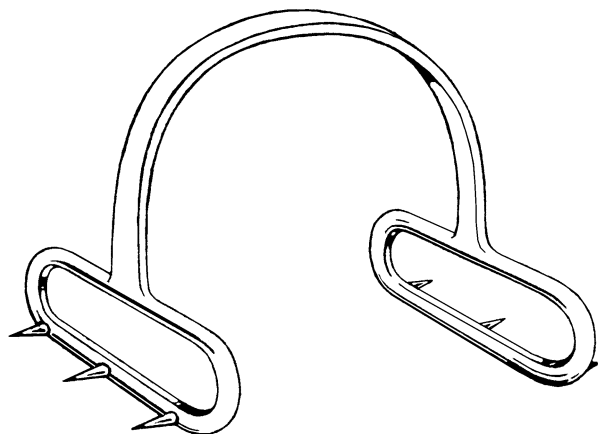

- 24600-13 Logans Traction Bow, 13mm

**24650-10** Anvil For Hand Surgery, base 100mm x 80mm

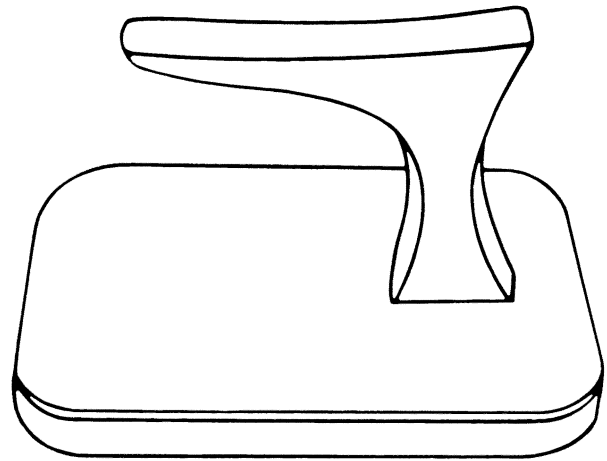

**24670-16** Prendiville Hand Table, 160mm square, 60mm high, with fixing posts for elastic bands

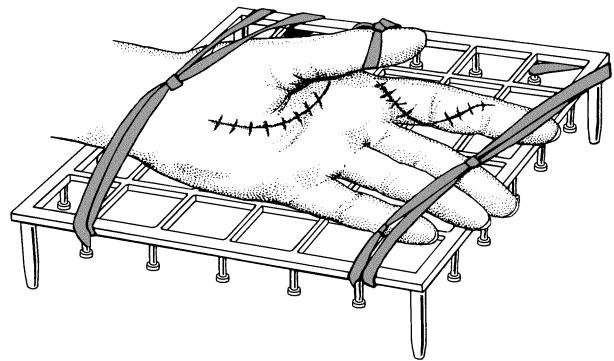

## Wire Forceps

**24700-11** Hayton Williams Wire Forcep, 110mm

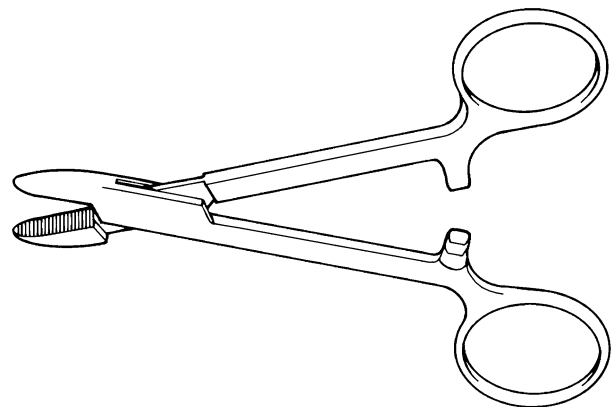

# Ear, Nose and Throat

## Adaptors



**31000-04** House Cut-Out Adaptor, luer, 40mm

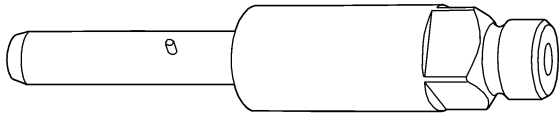

**31003-10** Welch Allyn Male Fitting To Fibrelight Stem Adaptor

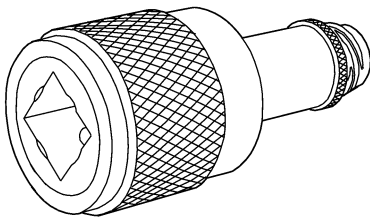

**31005-10** Universal Cable Fitting To Welch Allyn Female Adaptor

## Artery Forceps

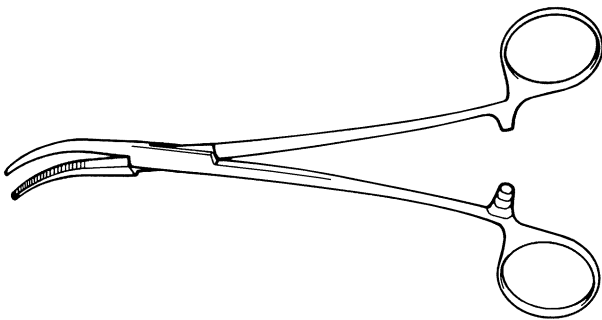

**31010-18** Birkett Artery Forcep, curved on flat, 180mm  
**31020-18** Birkett Artery Forcep, curved to side, 180mm

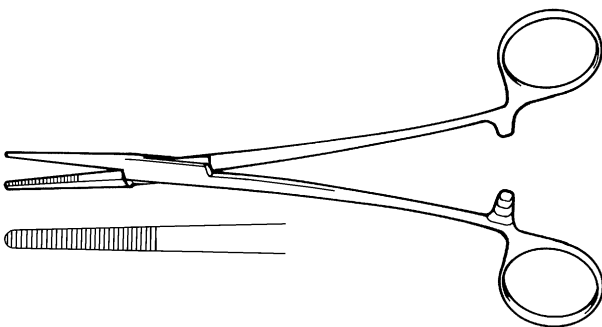

**31030-18** Birkett Artery Forcep, straight, 180mm

## Artery Forceps

**31040-18** Negus Artery Forcep, large curve, 180mm

**31050-18** Negus Artery Forcep, small curve, 180mm

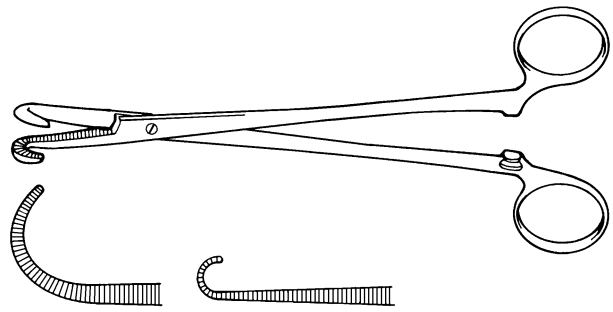

**31060-18** Sawtell Artery Forcep, curved on flat, 180mm

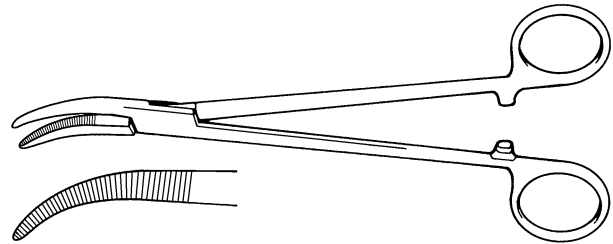

**31070-18** Schnidt Artery Forcep, curved on flat, 180mm

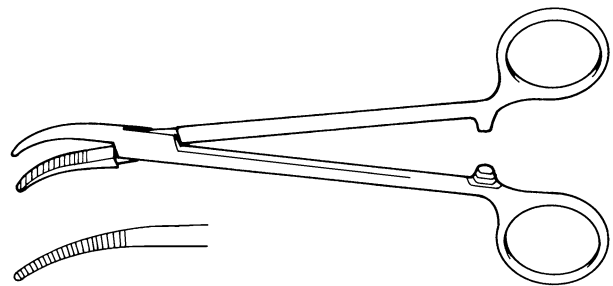

**31080-18** Wilson Artery Forcep, curved on flat, angled shaft, screw joint, 180mm

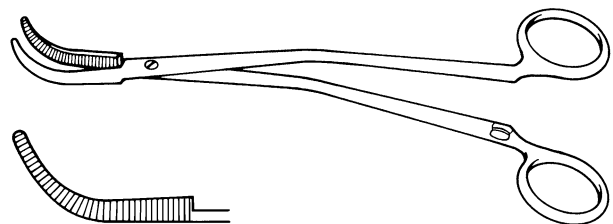

# Ear, Nose and Throat

## Aural Dressing Forceps

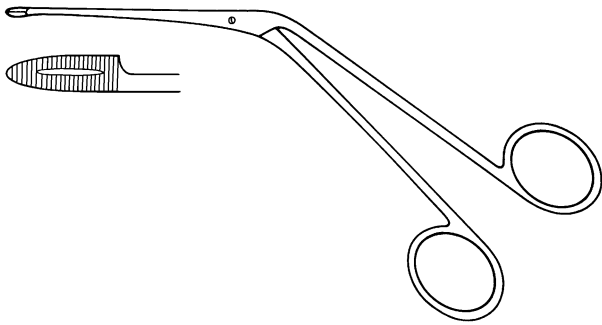

**31100-14** Hartmann Aural Dressing Forcep, serrated, screw joint, 140mm



**31110-15** Lucae Aural Dressing Forcep, serrated ends, 150mm

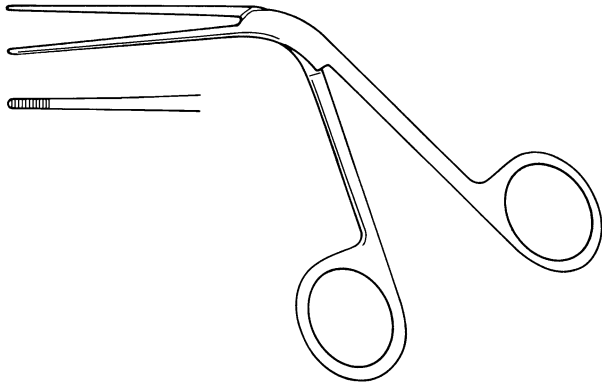

**31130-14** Tilley Aural Dressing Forcep, serrated ends, 145mm

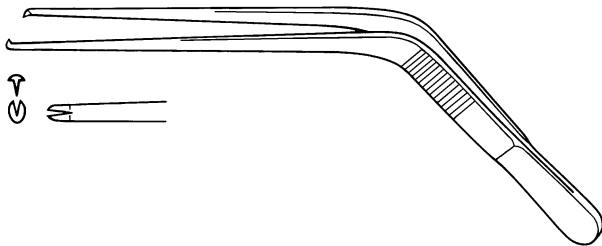

**31140-13** Wilde Aural Dressing Forcep, 1/2 teeth, 135mm

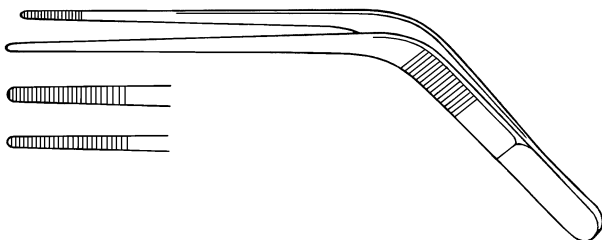

**31150-13** Wilde Aural Dressing Forcep, serrated ends, 135mm

**31160-13** Wilde Aural Dressing Forcep, serrated ends, extra fine, 135mm

**31200-70** Beales Aural Forcep, crocodile, black finish, extra fine, triangular jaws, 70mm effective

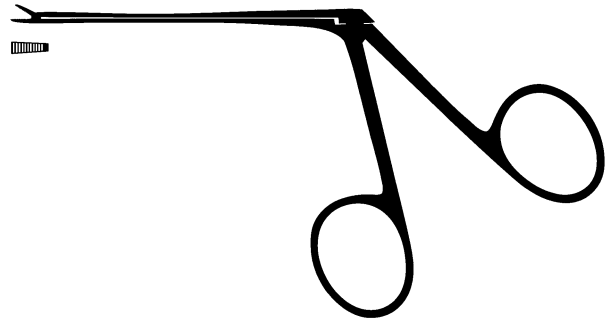

**31210-70** Cawthorne Aural Forcep, crocodile, black finish, extra fine, smooth jaws, 70mm effective

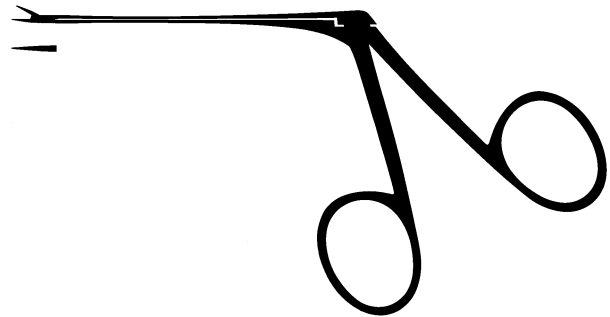

**31220-65** Fuller Aural Forcep, crocodile, black finish, 65mm effective

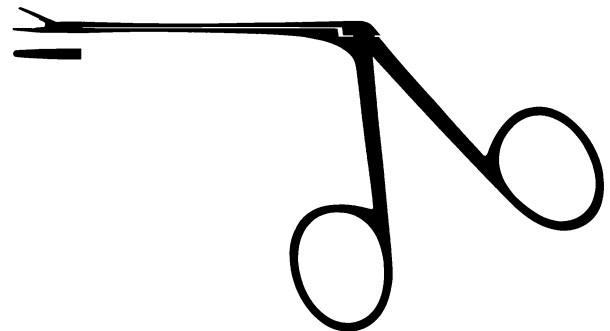

**31230-70** Hartmann Aural Forcep, crocodile, black finish, extra fine, 70mm

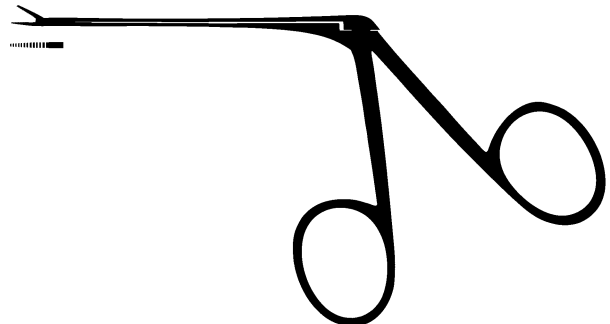

## Aural Forceps

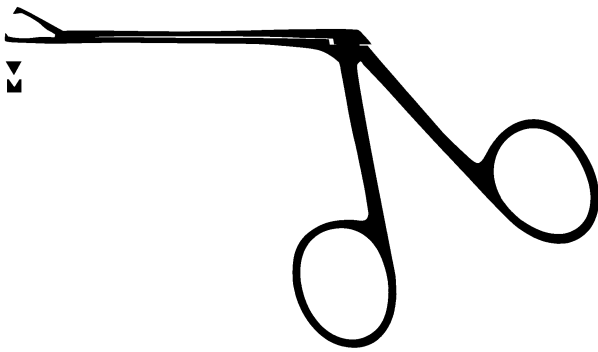

**31240-75** Hartmann Aural Forcep, crocodile, black finish, fine tenaculum jaws, 75mm effective

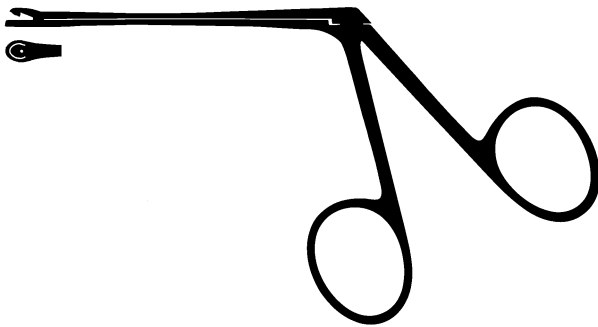

**31250-75** Hartmann Aural Forcep, crocodile, black finish, grunwald punch action jaws, 75mm effective

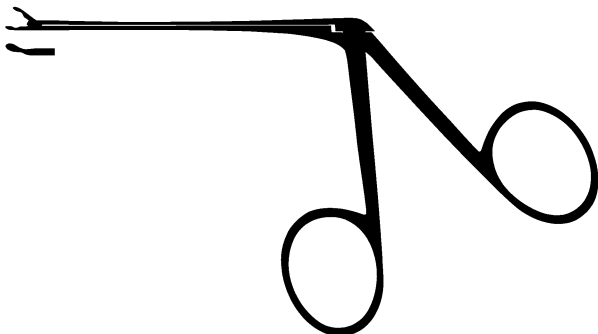

**31260-75** Hartmann Aural Forcep, crocodile, black finish, round cutting jaws, 75mm effective

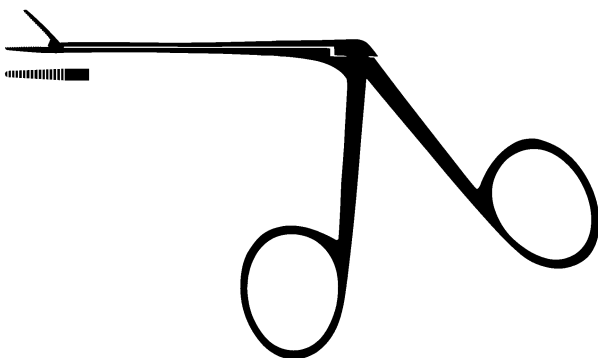

**31270-75** Hartmann Aural Forcep, crocodile, black finish, serrated jaws, 75mm effective



**Aural Forceps**

**31280-75** Henckel Aural Forcep, scoop blades, 75mm effective

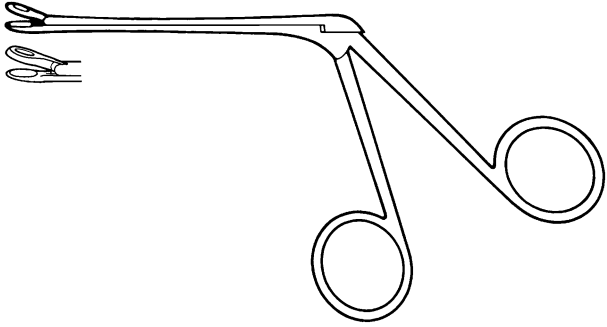

**31290-70** Hough Aural Forcep, crocodile, satin finish, 70mm effective

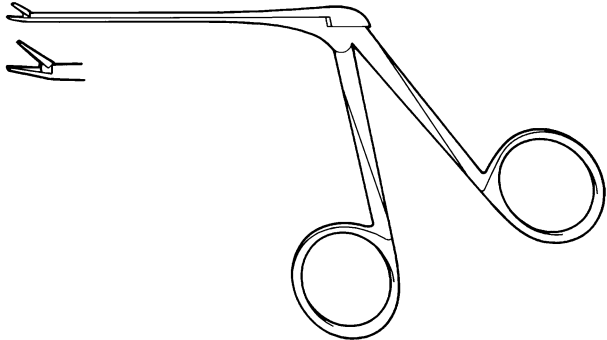

**31300-70** Hough Aural Forcep, crocodile, satin finish, angled to left, 70mm effective

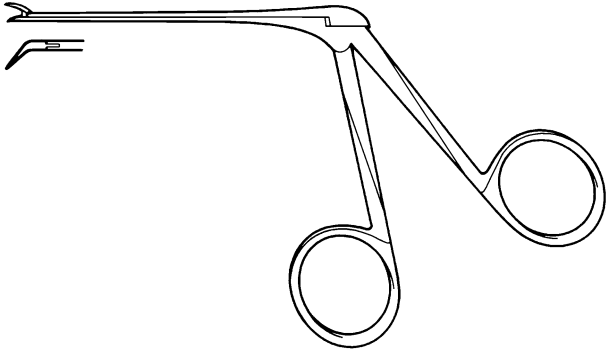

**31310-70** Hough Aural Forcep, crocodile, satin finish, angled to right, 70mm effective

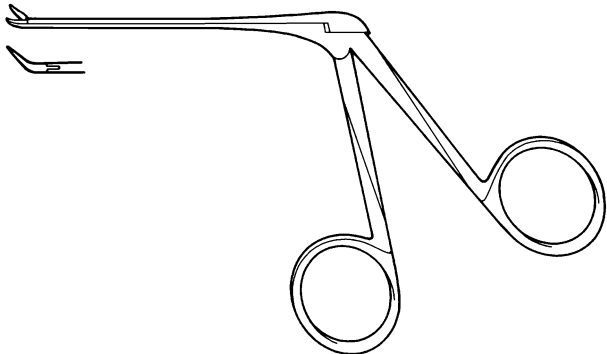

# Ear, Nose and Throat

## Aural Forceps

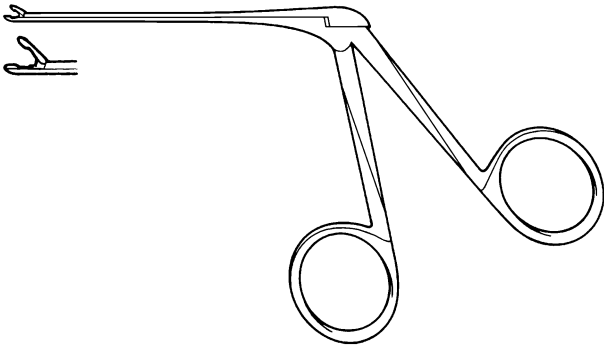

**31320-70** Hough Aural Forcep, crocodile, satin finish, oval cup, 70mm effective

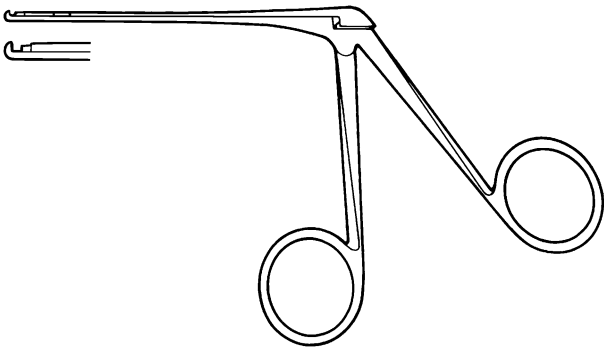

**31330-75** House-Dieter Malleus Aural Forcep, fine, satin finish, 75mm effective

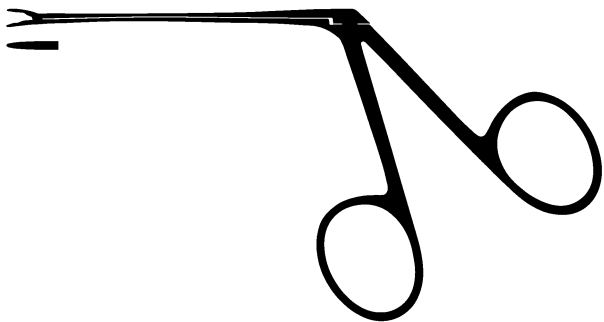

**31340-70** McGee Aural Forcep, crocodile, black finish, wire closing, 70mm effective

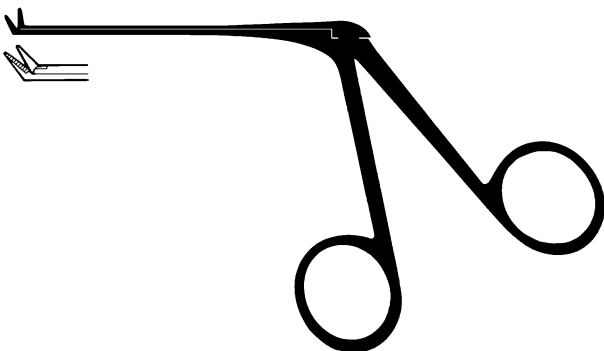

**31350-70** Ormerod Aural Forcep, crocodile, black finish, extra fine, angled upwards, 70mm effective

**31360-70** Ormerod Aural Forcep, crocodile, black finish, fine circular cup, 70mm effective

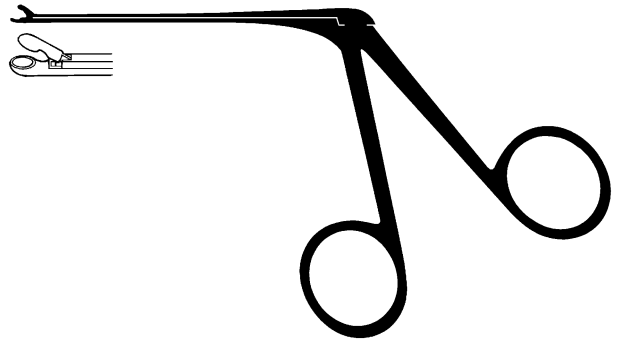

**31370-70** Ormerod Aural Forcep, crocodile, black finish, fine elongated cup, 70mm effective

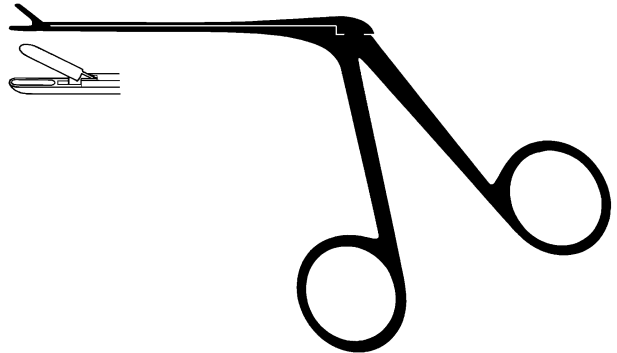

**31380-70** Shea Aural Forcep, crocodile, black finish, oval cup jaw, curved to left, 70mm effective

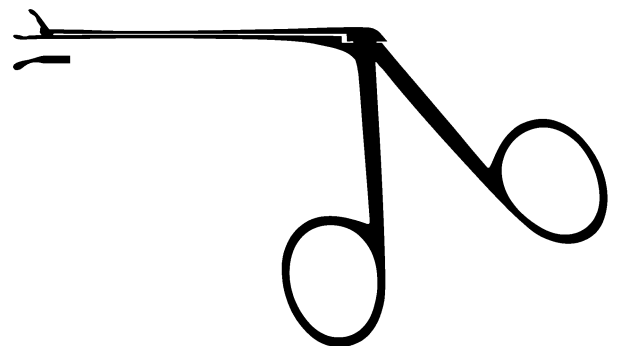

**31390-70** Shea Aural Forcep, crocodile, black finish, oval cup jaw, curved to right, 70mm effective

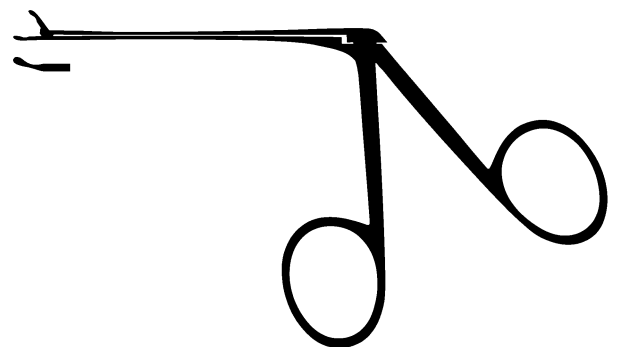

# Ear, Nose and Throat

## Aural Forceps

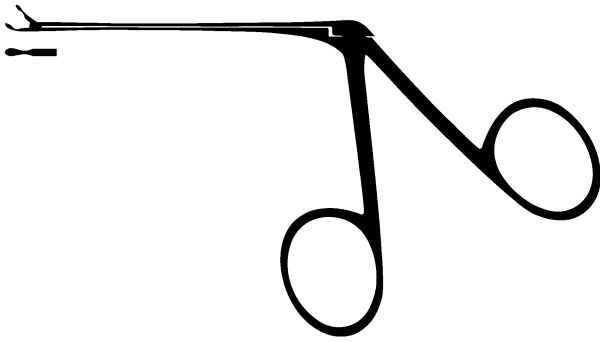

**31400-70** Shea Aural Forcep, crocodile, black finish, oval cup jaw, curved upward, 70mm effective

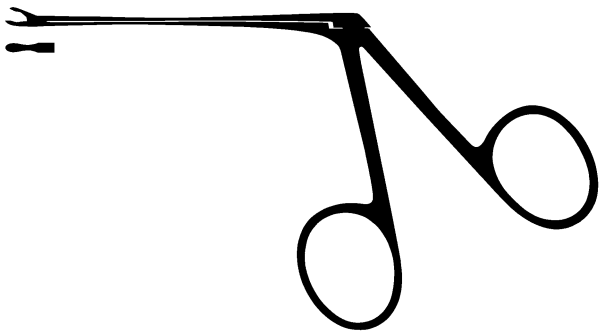

**31410-70** Shea Aural Forcep, crocodile, black finish, oval cup jaw, straight, 70mm effective

## Aural Instruments

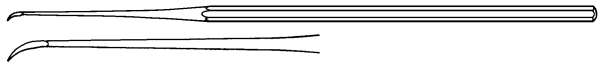

**31500-01** Beales Platinectomy Knife, for cutting stapedius tendon, satin finish, 170mm

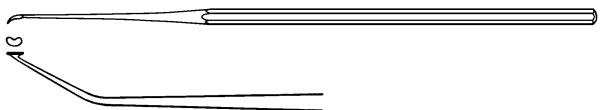

**31500-02** Beales Platinectomy Applicator, for vein graft, left, satin finish, 170mm

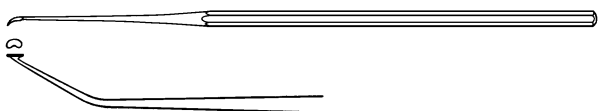

**31500-03** Beales Platinectomy Applicator for vein graft, right, satin finish, 170mm

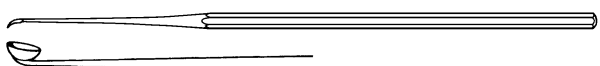

**31500-04** Beales Platinectomy Curette, for removal of rim, satin finish, 170mm

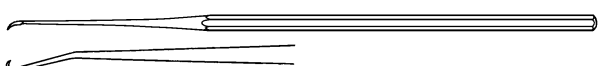

**31500-05** Beales Platinectomy Simpson Hall Hook, for removal of bone fragments, left, satin finish, 170mm

**31500-06** Beales Platinectomy Simpson Hall Hook, for removal of bone fragments, right, satin finish, 170mm

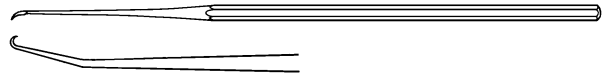

**31500-07** Beales Platinectomy Hook, for removal of footplate, right, satin finish, 170mm

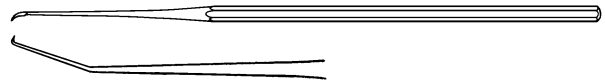

**31500-08** Beales Platinectomy Hook, for removal of footplate, left, satin finish, 170mm

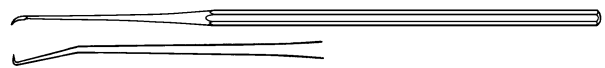

**31500-09** Beales Platinectomy Osteotome, for elevation of footplate, satin finish, 170mm

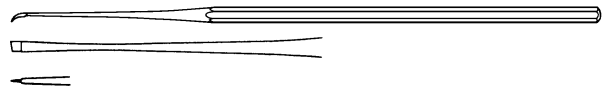

**31500-10** Beales Platinectomy Perforator, for footplate, satin finish, 170mm

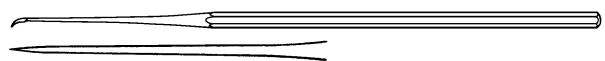

**31500-11** Beales Platinectomy Raspatory, for mucous membrane, satin finish, 170mm

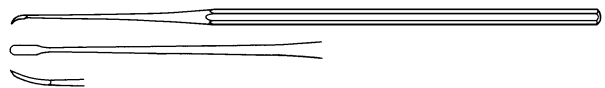

**31505-12** Beales Tympanoplasty Raspatory, slightly curved, large, satin finish, 165mm

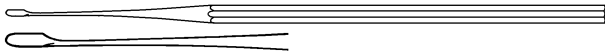

**31505-13** Beales Tympanoplasty Raspatory, slightly curved, small, satin finish, 165mm

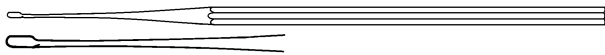

**31505-14** Beales Tympanoplasty Rugine, double ended, satin finish, 165mm

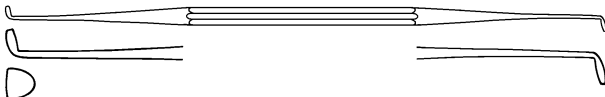

**31505-15** Beales Tympanoplasty Rugine, double ended, sharp ends, satin finish, 165mm



# Ear, Nose and Throat

## Aural Instruments

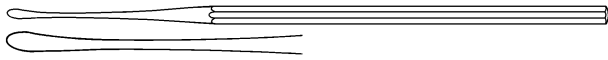

**31505-16** Beales Tympanoplasty Spatula, for smoothing graft, satin finish, 165mm

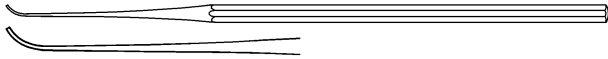

**31505-17** Beales Tympanoplasty Probe, fine, blunt end, satin finish, 165mm

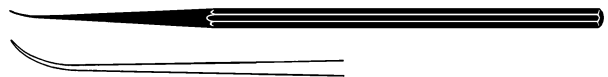

**31510-01** Cawthorne Hook, No.1, slight curve, black finish, 165mm

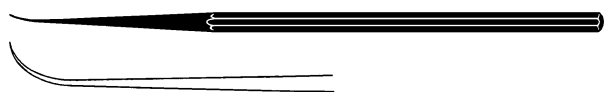

**31510-02** Cawthorne Hook, No.2, medium curve, black finish, 165mm

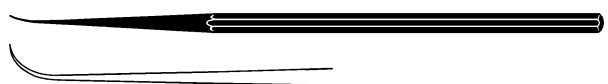

**31510-03** Cawthorne Hook, No.3, full curve, black finish, 165mm

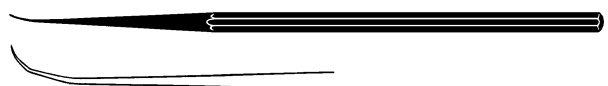

**31510-04** Cawthorne Hook, No.4, double curve, black finish, 165mm



**31510-05** Cawthorne Hook, No.5, 90 degree angle, 0.5mm, black finish, 165mm



**31510-06** Cawthorne Hook, No.6, 90 degree angle, 1.0mm, black finish, 165mm

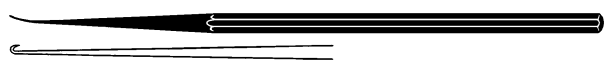

**31510-07** Cawthorne Hook, No.7, retrograde, black finish, 165mm

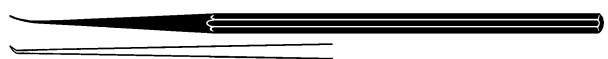

**31510-08** Cawthorne Hook, No.8, 45 degree angle, 0.5mm, black finish, 165mm

**31510-09** Cawthorne Hook, No.9, straight, black finish, 165mm



**31520-01** Cawthorne First Incision Knife And Elevator, black finish, 165mm



**31525-01** Cawthorne Strut Applicator, black finish, 165mm



**31540-01** Hough Whirlybird, large, right, No.1, satin finish, 165mm



**31540-02** Hough Whirlybird, large, left, No.2, satin finish, 165mm

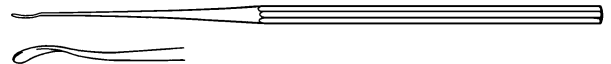

**31540-03** Hough Whirlybird, small, right, No.3, satin finish, 165mm



**31540-04** Hough Whirlybird, small, left, No.4, satin finish, 165mm



**31540-05** Hough Stapedectomy Pick, 90 degree, No.5, satin finish, 165mm

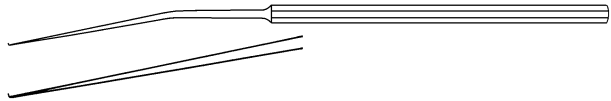

**31540-06** Hough Stapedectomy Pick, 45 degree, No.6, satin finish, 165mm



**31540-07** Hough Stapedectomy Pick, 15 degree, No.7, satin finish, 165mm

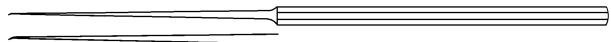

# Ear, Nose and Throat

## Aural Instruments

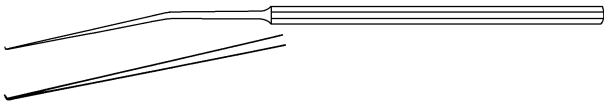

**31540-08** Hough Hoe, 90 degree, No.8, satin finish, 165mm

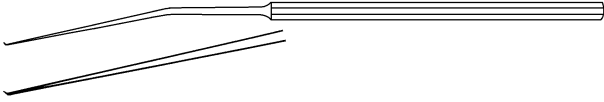

**31540-09** Hough Hoe, 45 degree, No.9, satin finish, 165mm



**31540-10** Hough Hoe, curved, No.10, satin finish, 165mm

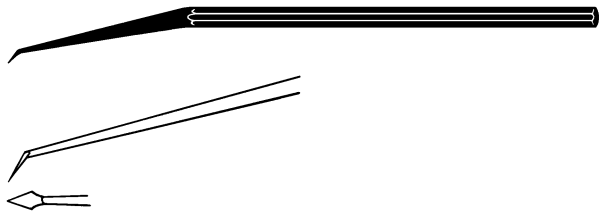

**31550-01** Ironside Knife, first incision, No.1, black finish, 165mm



**31550-02** Ironside Knife, horizontal incision, No.2, black finish, 165mm



**31550-03** Ironside Elevator, No.3, black finish, 165mm



**31550-04** Ironside Needle, sharp, No.4, black finish, 165mm



## Aural Instruments

**31550-05** Ironside Hook, 45 degree up, No.5, black finish, 165mm

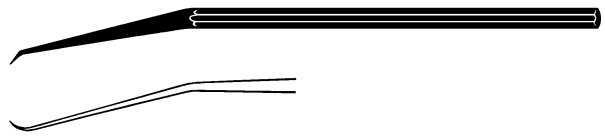

**31550-06** Ironside Hook, 45 degree down, No.6, black finish, 165mm

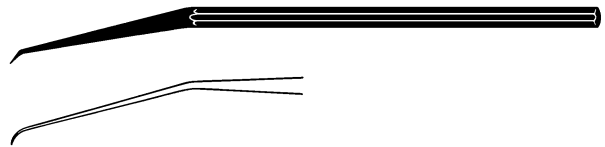

**31550-07** Ironside Hook, 90 degree up, No.7, black finish, 165mm

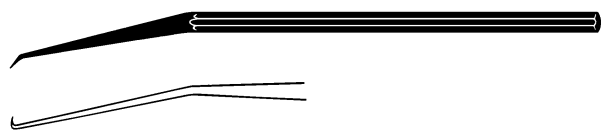

**31550-08** Ironside Hook, 90 degree down, No.8, black finish, 165mm

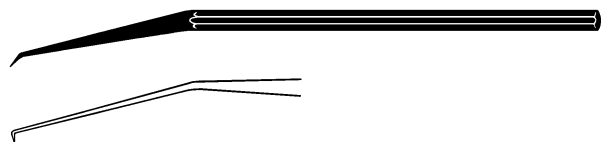

**31550-09** Ironside Measuring Device, No.9, black finish, 165mm

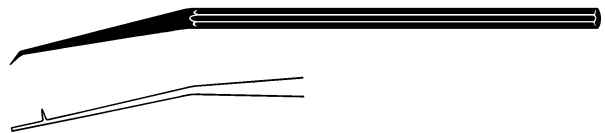

**31560-01** Rosen Knife, No.1, black finish, 160mm

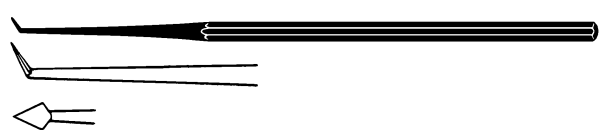

**31560-02** Rosen Elevator, No.2, bayonet shaped, broad, black finish, 190mm

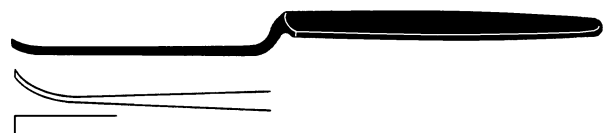

# Ear, Nose and Throat

## Aural Instruments

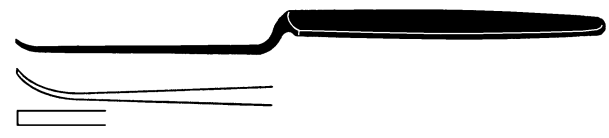

**31560-03** Rosen Elevator, No.3, bayonet shaped, narrow, black finish, 190mm



**31560-04** Rosen Elevator, No.4, black finish, 160mm

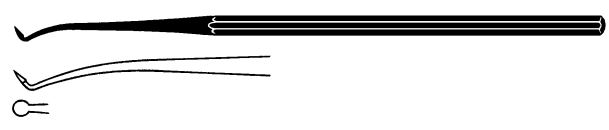

**31560-05** Rosen Curette, No.5, black finish, 160mm

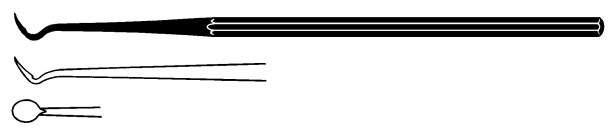

**31560-06** Rosen Curette, No.6, black finish, 160mm

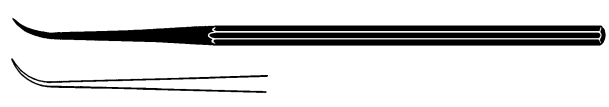

**31560-07** Rosen Probe, No.7, footplate, black finish, 160mm

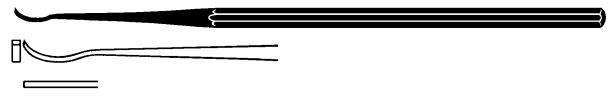

**31560-08** Rosen Mobiliser, No.8, black finish, 160mm

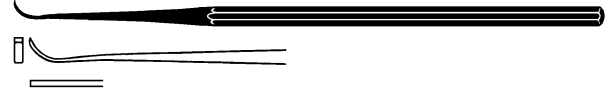

**31560-09** Rosen Mobiliser, No.9, black finish, 160mm



**31560-10** Rosen Fenestrator, No.10, cross chequered handle, black finish, 160mm

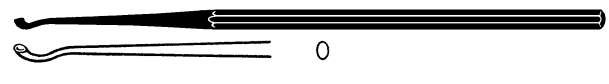

**31560-11** Rosen Scoop, No.11, oval, straight, size 000, black finish, 160mm

## Aural Instruments

**31560-12** Rosen Scoop, No.11, oval, straight, size 00, black finish, 160mm

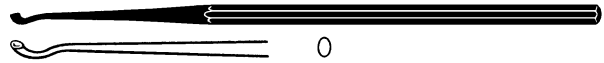

**31560-13** Rosen Scoop, No.11, oval, straight, size 0, black finish, 160mm

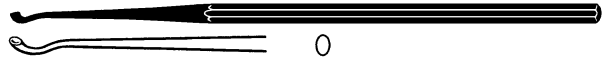

**31560-14** Rosen Scoop, No.11, oval, straight, size 1, black finish, 160mm



**31570-01** Schuknecht Micro-Hook, upward, black finish, 160mm

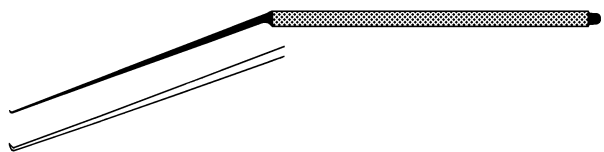

**31570-02** Schuknecht Micro-Hook, downward, black finish, 160mm

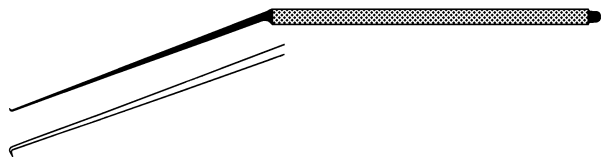

**31570-03** Schuknecht Hook, upward, black finish, 160mm

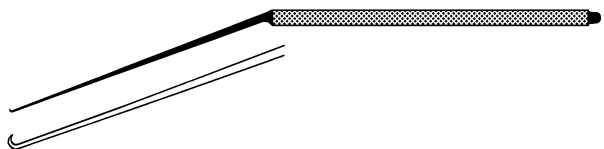

**31570-04** Schuknecht Hook, downward, black finish, 160mm

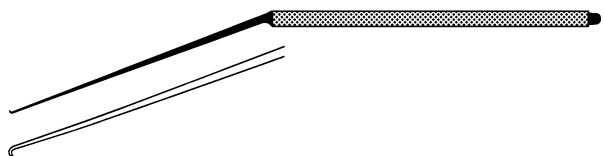

**31570-05** Schuknecht Elevator, oval window, black finish, 160mm

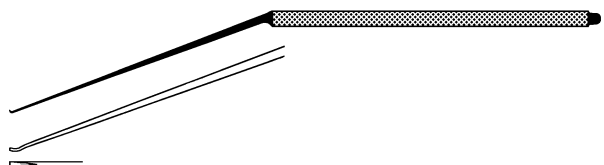

# Ear, Nose and Throat

## Aural Instruments

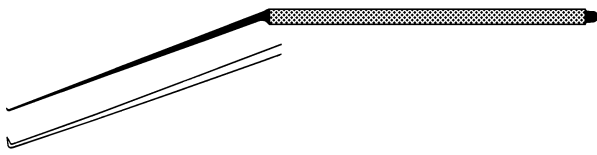

**31570-06** Schuknecht Hook, right angled upwards, black finish, 160mm

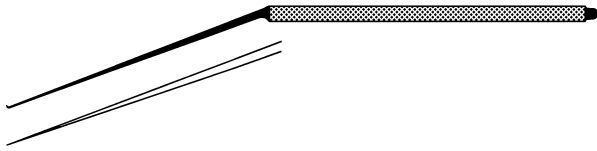

**31570-07** Schuknecht Pick, straight, black finish, 160mm

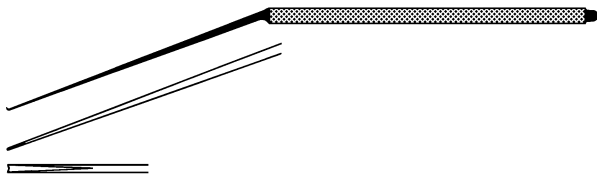

**31570-08** Schuknecht Spatula, straight, black finish, 160mm



**31580-01** Shea Incising Knife, A, angled, black finish, 160mm



**31580-02** Shea Curette, B, straight, black finish, 160mm



**31580-03** Shea Elevator, C, straight, left, black finish, 160mm



**31580-04** Shea Elevator, D, straight, right, black finish, 160mm



**31580-05** Shea Pick, E, straight, sharp, black finish, 160mm



**31580-06** Shea Fenestra Hook, F, straight, 25 degree, black finish, 160mm

## Aural Instruments

**31580-07** Shea Fenestra Hook, G, straight, 45 degree, black finish, 160mm



**31580-08** Shea Fenestra Hook, H, straight, 90 degree, black finish, 160mm



**31580-09** Shea Fenestra Hook, I, straight, 90 degree, short, black finish, 160mm

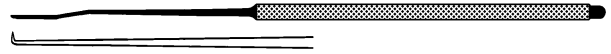

**31580-10** Shea Pick, J, straight, semi-blunt, right angled, black finish, 160mm



**31580-11** Shea Anterior Crurotomy Knife, K, straight, black finish, 160mm



**31590-10** Shea Piston Depth Gauge, 3.5mm, 4.0mm and 4.5mm from underside of footplate to underside of incus, black finish, 160mm



## Aural Snares

**31600-16** Glegg Aural Snare, self-forming, 165mm

**31600-50** Glegg Aural Snare, spare wire loop only, 34swg, pack of 10

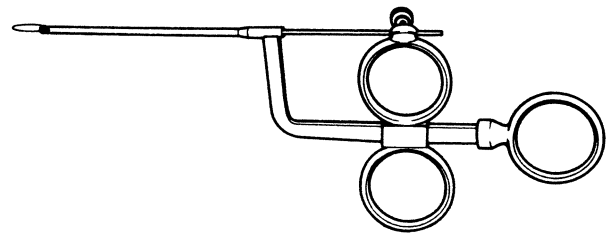

## Aural Specula

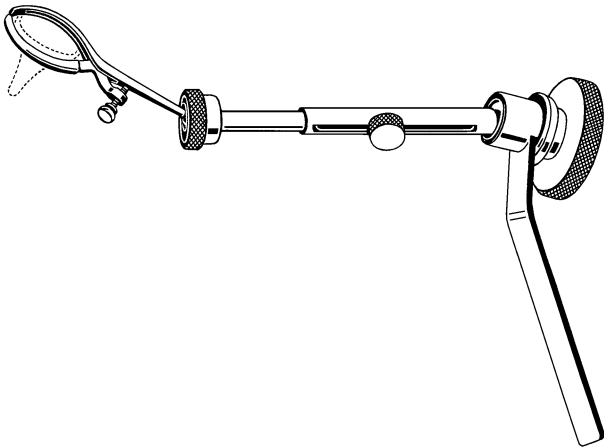

- 31650-50** Shea Aural Speculum Holder, s/s, matt finish, with flat bar 32mm x 6.5mm (1.1/4" x 1/4") to attach to operating table

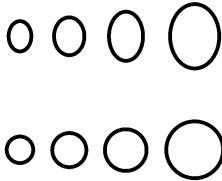
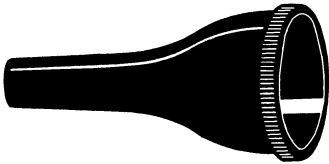

- 31700-10** Gruber Aural Speculum, oval end, black finish, 38mm, No.1, 2.5mm x 3.5mm bore
- 31700-20** Gruber Aural Speculum, oval end, black finish, 38mm, No.2, 3.5mm x 4.5mm bore
- 31700-30** Gruber Aural Speculum, oval end, black finish, 38mm, No.3, 4.0mm x 6.0mm bore
- 31700-40** Gruber Aural Speculum, oval end, black finish, 38mm, No.4, 6.0mm x 8.0mm bore
- 31700-85** Gruber Aural Speculum, oval end, black finish, 38mm, set of 3 (No.1 to No.3)
- 31700-90** Gruber Aural Speculum, oval end, black finish, 38mm, set of 4 (No.1 to No.4)
- 31702-30** Gruber Aural Speculum, round end, black finish, 38mm, 3.0mm bore
- 31702-40** Gruber Aural Speculum, round end, black finish, 38mm, 4.0mm bore
- 31702-50** Gruber Aural Speculum, round end, black finish, 38mm, 5.0mm bore
- 31702-70** Gruber Aural Speculum, round end, black finish, 38mm, 7.0mm bore
- 31702-85** Gruber Aural Speculum, round end, black finish, 38mm, set of 3 (3.0mm to 5.0mm)
- 31702-90** Gruber Aural Speculum, round end, black finish, 38mm, set of 4 (3.0mm to 7.0mm)

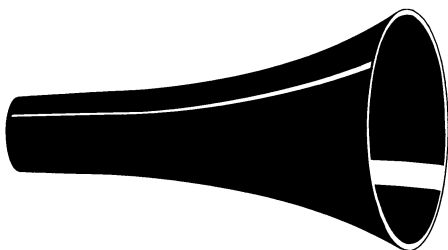

- 31704-40** Heath Aural Speculum, oval end, black finish, 48mm, 4.0mm x 6.0mm bore
- 31704-50** Heath Aural Speculum, oval end, black finish, 48mm, 5.0mm x 7.0mm bore
- 31704-60** Heath Aural Speculum, oval end, black finish, 48mm, 6.0mm x 8.0mm bore
- 31704-70** Heath Aural Speculum, oval end, black finish, 48mm, 7.0mm x 9.0mm bore
- 31704-90** Heath Aural Speculum, oval end, black finish, 48mm, set of 4

- 31708-10** Rosen Aural Speculum, slotted, oval end, black finish, 38mm, No.1, 2.5mm x 3.5mm bore
- 31708-20** Rosen Aural Speculum, slotted, oval end, black finish, 38mm, No.2, 3.5mm x 4.5mm bore
- 31708-30** Rosen Aural Speculum, slotted, oval end, black finish, 38mm, No.3, 4.0mm x 6.0mm bore
- 31708-40** Rosen Aural Speculum, slotted, oval end, black finish, 38mm, No.4, 5.0mm x 7.0mm bore
- 31708-50** Rosen Aural Speculum, slotted, oval end, black finish, 38mm, No.5, 6.0mm x 8.0mm bore
- 31708-85** Rosen Aural Speculum, slotted, oval end, black finish, 38mm, set of 4, No.2 - No.5
- 31708-90** Rosen Aural Speculum, slotted, oval end, black finish, 38mm, set of 5, No.1 - No.5
- 31710-30** Rosen Aural Speculum, slotted, round end, black finish, 38mm, 3.0mm bore
- 31710-40** Rosen Aural Speculum, slotted, round end, black finish, 38mm, 4.0mm bore
- 31710-50** Rosen Aural Speculum, slotted, round end, black finish, 38mm, 5.0mm bore
- 31710-60** Rosen Aural Speculum, slotted, round end, black finish, 38mm, 6.0mm bore
- 31710-70** Rosen Aural Speculum, slotted, round end, black finish, 38mm, 7.0mm bore
- 31710-85** Rosen Aural Speculum, slotted, round end, black finish, 38mm, set of 4, 4.0mm - 7.0mm bore
- 31710-90** Rosen Aural Speculum, slotted, round end, black finish, 38mm, set of 5, 3.0mm - 7.0mm bore

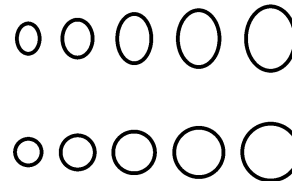
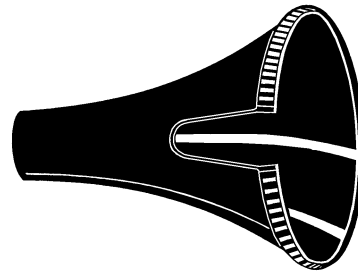

- 31709-10** Rosen Aural Speculum, unslotted, oval end, black finish, 38mm, No.1, 2.5mm x 3.5mm bore
- 31709-20** Rosen Aural Speculum, unslotted, oval end, black finish, 38mm, No.2, 3.5mm x 4.5mm bore
- 31709-30** Rosen Aural Speculum, unslotted, oval end, black finish, 38mm, No.3, 4.0mm x 6.0mm bore
- 31709-40** Rosen Aural Speculum, unslotted, oval end, black finish, 38mm, No.4, 5.0mm x 7.0mm bore
- 31709-50** Rosen Aural Speculum, unslotted, oval end, black finish, 38mm, No.5, 6.0mm x 8.0mm bore
- 31709-85** Rosen Aural Speculum, unslotted, oval end, black finish, 38mm, set of 4, No.2 - No.5
- 31709-90** Rosen Aural Speculum, unslotted, oval end, black finish, 38mm, set of 5, No.1 - No.5
- 31720-30** Rosen Aural Speculum, unslotted, round end, black finish, 38mm, 3.0mm bore
- 31720-40** Rosen Aural Speculum, unslotted, round end, black finish, 38mm, 4.0mm bore
- 31720-50** Rosen Aural Speculum, unslotted, round end, black finish, 38mm, 5.0mm bore
- 31720-60** Rosen Aural Speculum, unslotted, round end, black finish, 38mm, 6.0mm bore
- 31720-70** Rosen Aural Speculum, unslotted, round end, black finish, 38mm, 7.0mm bore
- 31720-85** Rosen Aural Speculum, unslotted, round end, black finish, 38mm, set of 4, 4.0mm - 7.0mm
- 31720-90** Rosen Aural Speculum, unslotted, round end, black finish, 38mm, set of 5, 3.0mm - 7.0mm bore

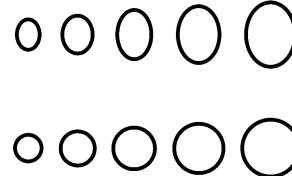
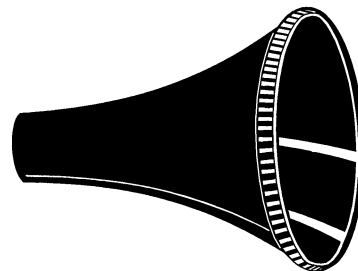

## Aural Specula



- 31730-33** Shea Aural Speculum, oblique end, black finish, 38mm, 3.3mm x 4.1mm bore
- 31730-40** Shea Aural Speculum, oblique end, black finish, 38mm, 4.0mm x 5.5mm bore
- 31730-50** Shea Aural Speculum, oblique end, black finish, 38mm, 5.0mm x 7.5mm bore
- 31730-60** Shea Aural Speculum, oblique end, black finish, 38mm, 6.0mm x 8.5mm bore
- 31730-70** Shea Aural Speculum, oblique end, black finish, 38mm, 7.0mm x 9.5mm bore
- 31730-90** Shea Aural Speculum, oblique end, black finish, 38mm, set of 5

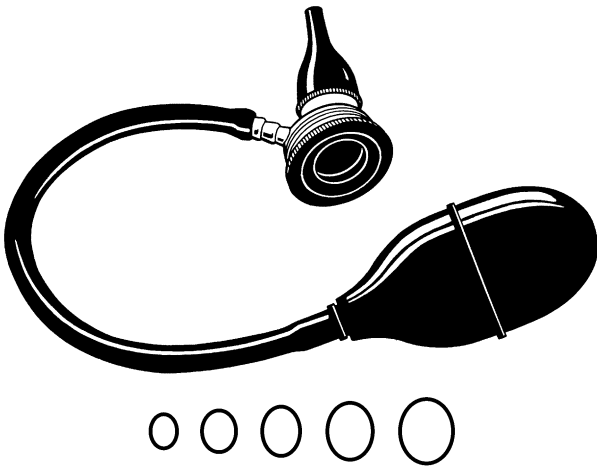

- 31740-10** Peters (Siegle) Aural Speculum, body only
- 31740-30** Peters (Siegle) Aural Speculum, lens only, magnifying
- 31740-50** Peters (Siegle) Aural Speculum, body and lens only, magnifying
- 31740-75** Peters (Siegle) Aural Speculum, rubber tube and bulb only
- 31740-90** Peters (Siegle) Aural Speculum, complete, magnifying, with 5 ear specula, rubber tube and bulb
- 31750-30** Peters (Siegle) Aural Speculum, lens only, plain
- 31750-50** Peters (Siegle) Aural Speculum, body and lens only, plain
- 31750-90** Peters (Siegle) Aural Speculum, complete, plain, with 5 ear specula, rubber tube and bulb
- 31760-00** Peters (Siegle) Aural Speculum, oval end, black finish, 42mm, No.0, 3.0mm x 4.0mm bore
- 31760-10** Peters (Siegle) Aural Speculum, oval end, black finish, 42mm, No.1, 4.0mm x 5.0mm bore
- 31760-20** Peters (Siegle) Aural Speculum, oval end, black finish, 42mm, No.2, 4.5mm x 6.0mm bore
- 31760-30** Peters (Siegle) Aural Speculum, oval end, black finish, 42mm, No.3, 5.5mm x 7.0mm bore
- 31760-40** Peters (Siegle) Aural Speculum, oval end, black finish, 42mm, No.4, 6.5mm x 8.0mm bore
- 31760-85** Peters (Siegle) Aural Speculum, oval end, black finish, 42mm, set of 4 (No.1 - No.4)
- 31760-90** Peters (Siegle) Aural Speculum, oval end, black finish, 42mm, set of 5 (No.0 - No.4)



- 31770-50** Toynbee Aural Speculum, black finish, 41mm, 5.0mm bore
- 31770-60** Toynbee Aural Speculum, black finish, 41mm, 6.0mm bore
- 31770-70** Toynbee Aural Speculum, black finish, 41mm, 7.0mm bore
- 31770-90** Toynbee Aural Speculum, black finish, 41mm, set of 3



## Aural Specula

- 31780-00** Tumarkin Aural Speculum, tapered slot, black finish, 51mm, size 0, 3.5mm bore
- 31780-05** Tumarkin Aural Speculum, tapered slot, black finish, 51mm, size 0.5, 4.5mm bore
- 31780-10** Tumarkin Aural Speculum, tapered slot, black finish, 51mm, size 1, 5.5mm bore
- 31780-20** Tumarkin Aural Speculum, tapered slot, black finish, 51mm, size 2, 6.0mm bore
- 31780-30** Tumarkin Aural Speculum, tapered slot, black finish, 51mm, size 3, 6.5mm bore
- 31780-40** Tumarkin Aural Speculum, tapered slot, black finish, 51mm, size 4, 7.0mm bore
- 31780-50** Tumarkin Aural Speculum, tapered slot, black finish, 51mm, size 5, 7.5mm bore
- 31780-60** Tumarkin Aural Speculum, tapered slot, black finish, 51mm, size 6, 8.0mm bore
- 31780-70** Tumarkin Aural Speculum, tapered slot, black finish, 51mm, size 7, 10.0mm bore
- 31780-90** Tumarkin Aural Speculum, tapered slot, black finish, 51mm, set of 8

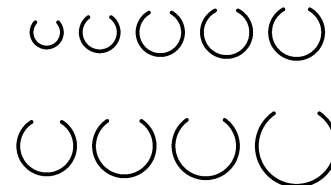
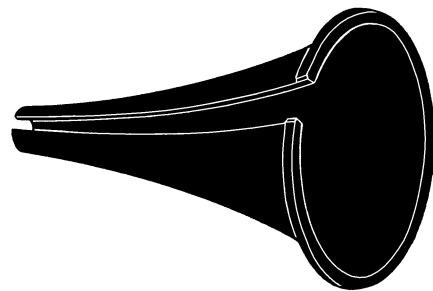

## Biopsy Forceps

- 31800-28** Chevalier Jackson Biopsy Forcep, basket jaw with round end, 280mm effective length
- 31800-55** Chevalier Jackson Biopsy Forcep, basket jaw with round end, 550mm effective length

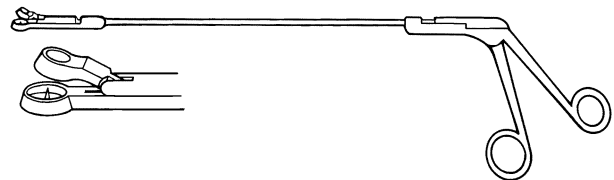

- 31810-35** Chevalier Jackson Biopsy Forcep, basket lower jaw, 350mm effective length
- 31810-40** Chevalier Jackson Biopsy Forcep, basket lower jaw, 400mm effective length
- 31810-45** Chevalier Jackson Biopsy Forcep, basket lower jaw, 450mm effective length
- 31810-50** Chevalier Jackson Biopsy Forcep, basket lower jaw, 500mm effective length
- 31810-55** Chevalier Jackson Biopsy Forcep, basket lower jaw, 550mm effective length
- 31810-60** Chevalier Jackson Biopsy Forcep, basket lower jaw, 600mm effective length

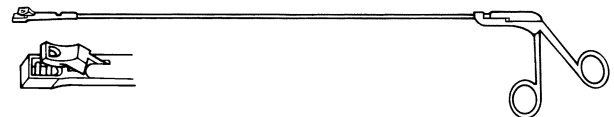

- 31820-20** Paterson Biopsy Forcep, 200mm effective length
- 31820-25** Paterson Biopsy Forcep, 250mm effective length
- 31820-30** Paterson Biopsy Forcep, 300mm effective length
- 31820-35** Paterson Biopsy Forcep, 350mm effective length
- 31820-40** Paterson Biopsy Forcep, 400mm effective length
- 31820-45** Paterson Biopsy Forcep, 450mm effective length
- 31820-50** Paterson Biopsy Forcep, 500mm effective length
- 31820-55** Paterson Biopsy Forcep, 550mm effective length
- 31820-60** Paterson Biopsy Forcep, 600mm effective length

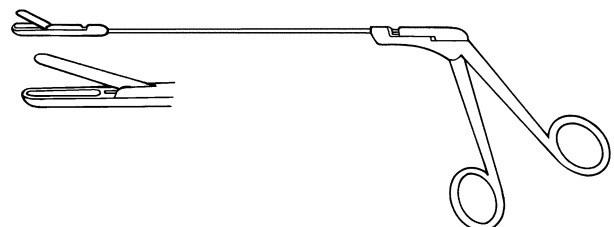

# Ear, Nose and Throat

## Biopsy Forceps

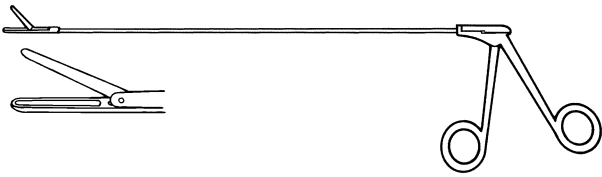

- 31830-35** Paterson Biopsy Forcep, extra fine, 350mm effective length
- 31830-45** Paterson Biopsy Forcep, extra fine, 450mm effective length

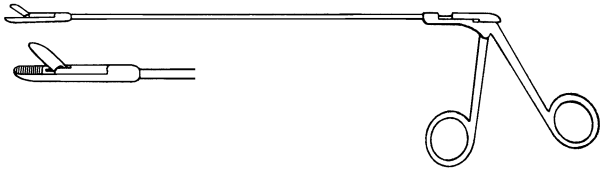

- 31840-35** Royal National ENT Hospital Biopsy Forcep, extra fine, 350mm

## Bipods

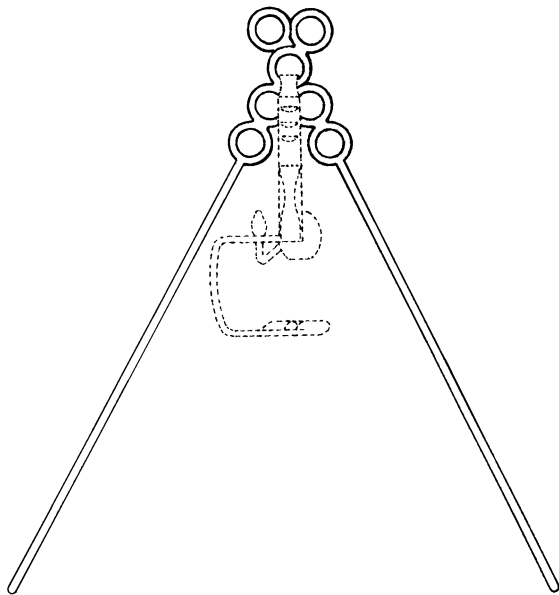

- 31900-45** Draffin Bipod, s/s, 450mm, 3 ring, pair
- 31900-48** Draffin Bipod, s/s, 480mm, 4 ring, pair

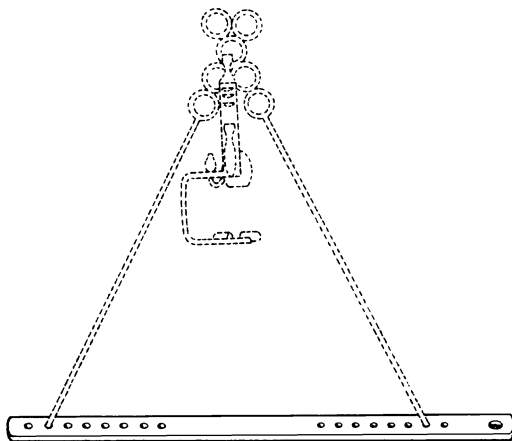

- 31910-40** Magauran Plate, s/s, to hold Bipod, 500mm

31960-70 Bone Crusher, 70mm

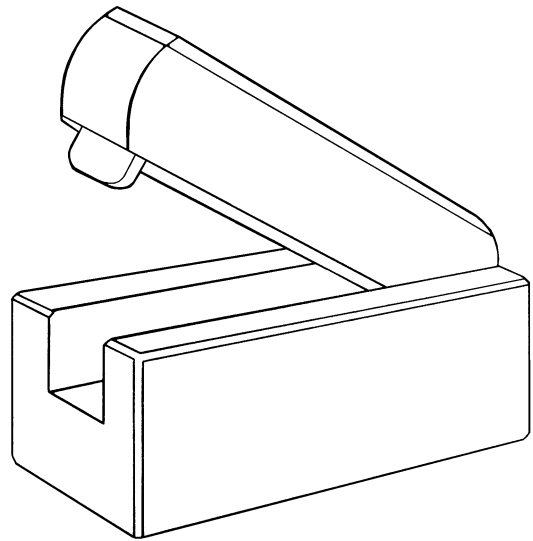

## Bronchoscopes

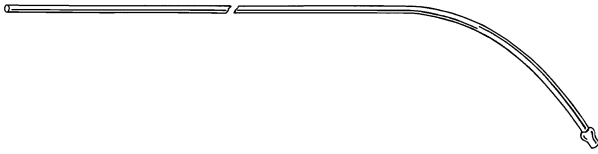

- 32000-20** Aspirating Tube, s/s, 2mm, 200mm effective
- 32000-25** Aspirating Tube, s/s, 2mm, 250mm effective
- 32000-30** Aspirating Tube, s/s, 2mm, 300mm effective
- 32000-35** Aspirating Tube, s/s, 2mm, 350mm effective
- 32000-40** Aspirating Tube, s/s, 2mm, 400mm effective
- 32000-45** Aspirating Tube, s/s, 2mm, 450mm effective
- 32000-50** Aspirating Tube, s/s, 2mm, 500mm effective
- 32000-55** Aspirating Tube, s/s, 2mm, 550mm effective
- 32000-60** Aspirating Tube, s/s, 2mm, 600mm effective
- 32010-20** Aspirating Tube, s/s, 3mm, 200mm effective
- 32010-25** Aspirating Tube, s/s, 3mm, 250mm effective
- 32010-30** Aspirating Tube, s/s, 3mm, 300mm effective
- 32010-35** Aspirating Tube, s/s, 3mm, 350mm effective
- 32010-40** Aspirating Tube, s/s, 3mm, 400mm effective
- 32010-45** Aspirating Tube, s/s, 3mm, 450mm effective
- 32010-50** Aspirating Tube, s/s, 3mm, 500mm effective
- 32010-55** Aspirating Tube, s/s, 3mm, 550mm effective
- 32010-60** Aspirating Tube, s/s, 3mm, 600mm effective
- 32020-20** Aspirating Tube, s/s, 4mm, 200mm effective
- 32020-25** Aspirating Tube, s/s, 4mm, 250mm effective
- 32020-30** Aspirating Tube, s/s, 4mm, 300mm effective
- 32020-35** Aspirating Tube, s/s, 4mm, 350mm effective
- 32020-40** Aspirating Tube, s/s, 4mm, 400mm effective
- 32020-45** Aspirating Tube, s/s, 4mm, 450mm effective
- 32020-50** Aspirating Tube, s/s, 4mm, 500mm effective
- 32020-55** Aspirating Tube, s/s, 4mm, 550mm effective
- 32020-60** Aspirating Tube, s/s, 4mm, 600mm effective
- 32030-20** Aspirating Tube, s/s, 5mm, 200mm effective
- 32030-25** Aspirating Tube, s/s, 5mm, 250mm effective
- 32030-30** Aspirating Tube, s/s, 5mm, 300mm effective
- 32030-35** Aspirating Tube, s/s, 5mm, 350mm effective
- 32030-40** Aspirating Tube, s/s, 5mm, 400mm effective
- 32030-45** Aspirating Tube, s/s, 5mm, 450mm effective
- 32030-50** Aspirating Tube, s/s, 5mm, 500mm effective
- 32030-55** Aspirating Tube, s/s, 5mm, 550mm effective
- 32030-60** Aspirating Tube, s/s, 5mm, 600mm effective
- 32040-20** Aspirating Tube, s/s, 6mm, 200mm effective
- 32040-25** Aspirating Tube, s/s, 6mm, 250mm effective
- 32040-30** Aspirating Tube, s/s, 6mm, 300mm effective
- 32040-35** Aspirating Tube, s/s, 6mm, 350mm effective
- 32040-40** Aspirating Tube, s/s, 6mm, 400mm effective
- 32040-45** Aspirating Tube, s/s, 6mm, 450mm effective
- 32040-50** Aspirating Tube, s/s, 6mm, 500mm effective
- 32040-55** Aspirating Tube, s/s, 6mm, 550mm effective
- 32040-60** Aspirating Tube, s/s, 6mm, 600mm effective

## Burs

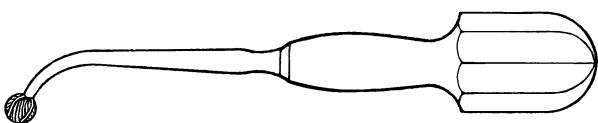

- 32100-06** Tilley Antrum Bur, 170mm, 6mm diameter
- 32100-07** Tilley Antrum Bur, 170mm, 7mm diameter
- 32100-08** Tilley Antrum Bur, 170mm, 8mm diameter

## Cannulae

**32220-40** Watson-Williams Cannula, luer, malleable, 4mm

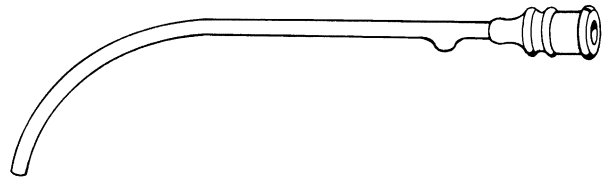

## Catheters

**32290-07** Woakes Eustachian Catheter, s/p, luer, 140mm, 7FG (2.3mm)

**32290-08** Woakes Eustachian Catheter, s/p, luer, 140mm, 8FG (2.7mm)

**32290-09** Woakes Eustachian Catheter, s/p, luer, 140mm, 9FG (3.0mm)

**32290-10** Woakes Eustachian Catheter, s/p, luer, 140mm, 10FG (3.3mm)

**32290-11** Woakes Eustachian Catheter, s/p, luer, 140mm, 11FG (3.7mm)

**32300-07** Woakes Eustachian Catheter, silver, luer, 140mm, 7FG (2.3mm)

**32300-08** Woakes Eustachian Catheter, silver, luer, 140mm, 8FG (2.7mm)

**32300-09** Woakes Eustachian Catheter, silver, luer, 140mm, 9FG (3.0mm)

**32300-10** Woakes Eustachian Catheter, silver, luer, 140mm, 10FG (3.3mm)

**32300-11** Woakes Eustachian Catheter, silver, luer, 140mm, 11FG (3.7mm)

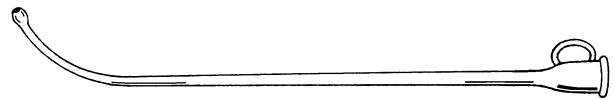

## Cerumen Hooks

**32500-14** Cawthorne Cerumen Hook, 145mm

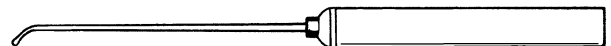

**32510-17** Formby Cerumen Hook, 175mm



**32520-14** Hartmann Cerumen Hook, sharp, 140mm



**32530-10** Lucae Cerumen Hook, 140mm, large

**32530-20** Lucae Cerumen Hook, 140mm, medium

**32530-30** Lucae Cerumen Hook, 140mm, small

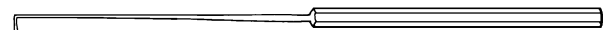

**32540-17** St.Barts Cerumen Hook, blunt, 175mm



# Ear, Nose and Throat

## Cocanising Wires

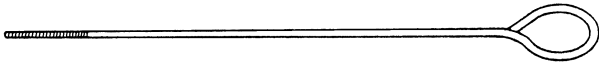

- 32600-08** Kings College Hospital Cocanising Wire, silver, 89mm
- 32600-13** Kings College Hospital Cocanising Wire, silver, 133mm

## Conchotomes

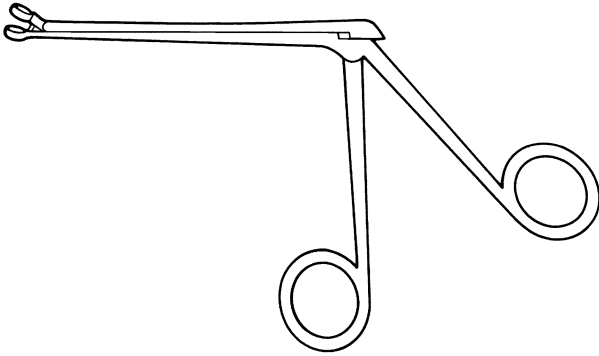

- 32700-05** Hartmann Conchotome, circular cutting, 100mm, 5mm diameter
- 32700-07** Hartmann Conchotome, circular cutting, 100mm, 7mm diameter
- 32700-09** Hartmann Conchotome, circular cutting, 100mm, 9mm diameter
- 32700-11** Hartmann Conchotome, circular cutting, 100mm, 11mm diameter

## Curettes

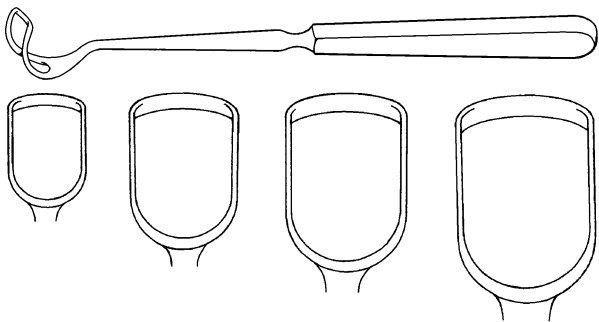

- 32800-10** Barnhill Curette, length 215mm, 10mm
- 32800-14** Barnhill Curette, length 215mm, 14mm
- 32800-16** Barnhill Curette, length 215mm, 16mm
- 32800-18** Barnhill Curette, length 215mm, 18mm

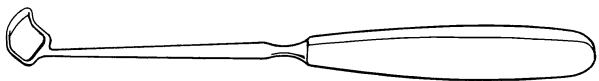

- 32810-08** Beckmann Curette, length 215mm, 8mm
- 32810-10** Beckmann Curette, length 215mm, 10mm
- 32810-12** Beckmann Curette, length 215mm, 12mm
- 32810-14** Beckmann Curette, length 215mm, 14mm
- 32810-16** Beckmann Curette, length 215mm, 16mm
- 32810-18** Beckmann Curette, length 215mm, 18mm

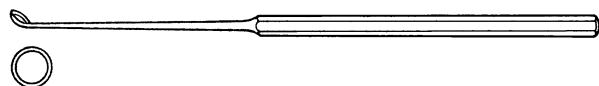

- 32820-20** Buck Curette, angled, blunt, 2.0mm bore
- 32820-25** Buck Curette, angled, blunt, 2.5mm bore
- 32820-30** Buck Curette, angled, blunt, 3.0mm bore
- 32820-35** Buck Curette, angled, blunt, 3.5mm bore
- 32820-40** Buck Curette, angled, blunt, 4.0mm bore
- 32830-20** Buck Curette, angled, sharp, 2.0mm bore
- 32830-25** Buck Curette, angled, sharp, 2.5mm bore
- 32830-30** Buck Curette, angled, sharp, 3.0mm bore
- 32830-35** Buck Curette, angled, sharp, 3.5mm bore
- 32830-40** Buck Curette, angled, sharp, 4.0mm bore

- 32840-20** Buck Curette, straight, blunt, 2.0mm bore
- 32840-25** Buck Curette, straight, blunt, 2.5mm bore
- 32840-30** Buck Curette, straight, blunt, 3.0mm bore
- 32840-35** Buck Curette, straight, blunt, 3.5mm bore
- 32840-40** Buck Curette, straight, blunt, 4.0mm bore
- 32850-20** Buck Curette, straight, sharp, 2.0mm bore
- 32850-25** Buck Curette, straight, sharp, 2.5mm bore
- 32850-30** Buck Curette, straight, sharp, 3.0mm bore
- 32850-35** Buck Curette, straight, sharp, 3.5mm bore
- 32850-40** Buck Curette, straight, sharp, 4.0mm bore

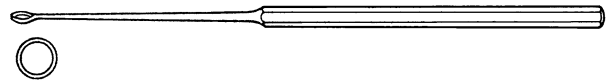

- 32857-10** Guilford Wright Curette, No.1, 125mm, 1mm
- 32857-20** Guilford Wright Curette, No.2, 125mm, 2mm
- 32857-30** Guilford Wright Curette, No.3, 125mm, 3mm
- 32857-40** Guilford Wright Curette, No.4, 125mm, 4mm

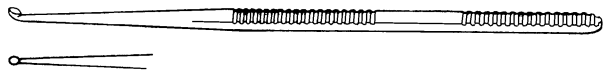

- 32859-20** Hallpike Ring Curette, upward, 150mm

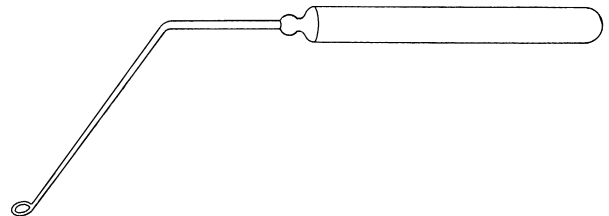

- 32859-30** Hallpike Ring Curette, downward, 150mm

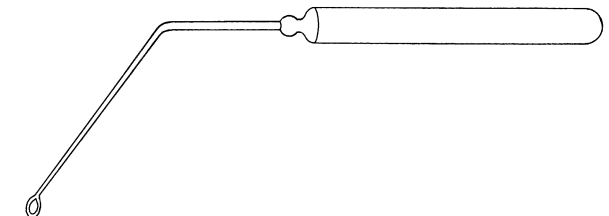

- 32860-15** House Curette, angled, double ended, 150mm
- 32860-18** House Curette, angled, double ended, 180mm

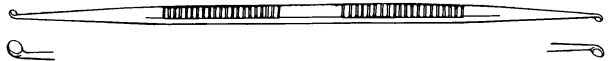

- 32870-15** House Curette, straight, double ended, 150mm
- 32870-18** House Curette, straight, double ended, 180mm

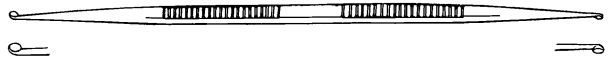

# Ear, Nose and Throat

## Curettes

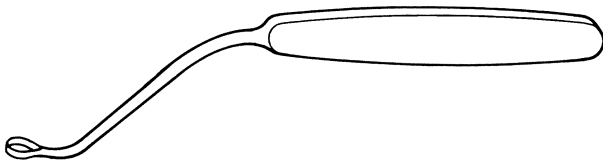

- 32880-06** Mackie Curette, length 195mm, 6mm diameter
- 32880-08** Mackie Curette, length 195mm, 8mm diameter
- 32880-09** Mackie Curette, length 195mm, 9mm diameter

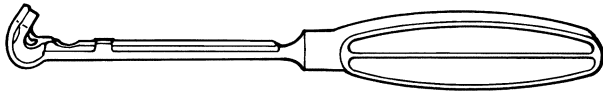

- 32890-08** St.Clair Thomson Curette, length 235mm, 8mm
- 32890-10** St.Clair Thomson Curette, length 235mm, 10mm
- 32890-12** St.Clair Thomson Curette, length 235mm, 12mm
- 32890-14** St.Clair Thomson Curette, length 235mm, 14mm
- 32890-16** St.Clair Thomson Curette, length 235mm, 16mm
- 32890-18** St.Clair Thomson Curette, length 235mm, 18mm

## Dissectors

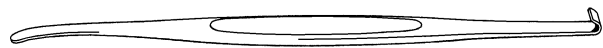

- 33200-20** Beavis Dissector, double ended, 205mm

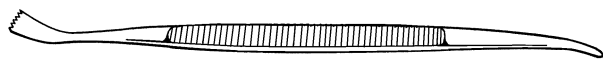

- 33210-06** Gwynne Evans Dissector, double ended, 195mm, 6mm wide
- 33210-08** Gwynne Evans Dissector, double ended, 195mm, 8mm wide

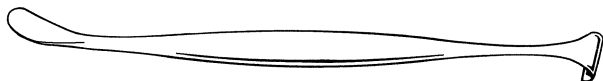

- 33220-19** Hurd Dissector, double ended, 195mm

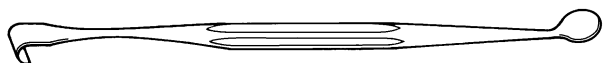

- 33230-21** Mollison Dissector, double ended, 215mm

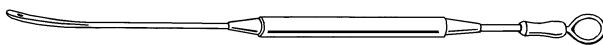

- 33240-20** Negus Aspirating Dissector, 205mm
- 33240-50** Negus Aspirating Dissector, stilette only

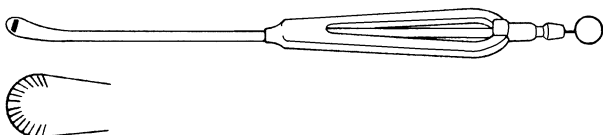

- 33260-26** Popper Dissector, 265mm



- 33270-16** St.Clair Thomson Dissector, blunt, 160mm



## Dissectors

**33280-16** St.Clair Thomson Dissector, sharp, 160mm



**33290-18** Syme Dissector, one blunt, one semi-sharp end, 180mm

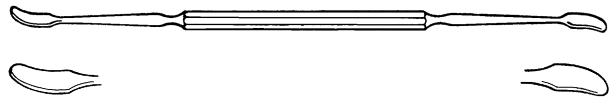

**33295-19** Weir Nasal Sucker / Dissector, 190mm



## Elevators

**33350-16** Cottle Elevator, single ended, 160mm

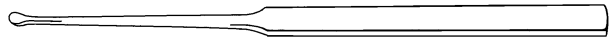

**33360-21** Cottle Elevator, double ended, 210mm

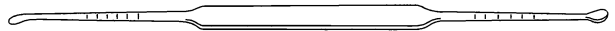

**33370-23** Cottle Elevator, double ended, curved, 235mm

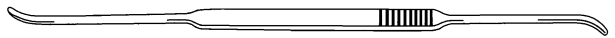

**33400-20** Freer Elevator, double ended, sharp / blunt, 200mm

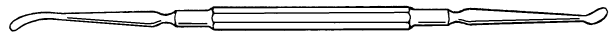

**33402-20** Freer Elevator, double ended, sharp / knife curved to side, 200mm

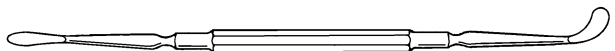

**33410-22** Hill Elevator, double ended, curved to side, 220mm



## Gouges

**33500-12** Guys Gouge, shallow groove, length 125mm



## Ear, Nose and Throat

### Gouges

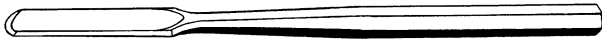

- 33510-01** Jenkins Gouge, length 140mm, 1mm
- 33510-02** Jenkins Gouge, length 140mm, 2mm
- 33510-03** Jenkins Gouge, length 140mm, 3mm
- 33510-04** Jenkins Gouge, length 140mm, 4mm
- 33510-05** Jenkins Gouge, length 140mm, 5mm
- 33510-06** Jenkins Gouge, length 140mm, 6mm
- 33510-07** Jenkins Gouge, length 140mm, 7mm
- 33510-08** Jenkins Gouge, length 140mm, 8mm
- 33510-09** Jenkins Gouge, length 140mm, 9mm
- 33510-10** Jenkins Gouge, length 140mm, 10mm
- 33510-11** Jenkins Gouge, length 140mm, 11mm
- 33510-12** Jenkins Gouge, length 140mm, 12mm
- 33510-13** Jenkins Gouge, length 140mm, 13mm
- 33510-14** Jenkins Gouge, length 140mm, 14mm



- 33520-03** Killian Gouge, length 125mm, 3mm
- 33520-04** Killian Gouge, length 125mm, 4mm
- 33520-05** Killian Gouge, length 125mm, 5mm



- 33530-12** Tilley Gouge, V shaped, length 145mm

### Insufflators

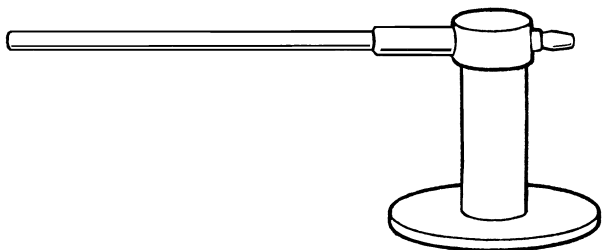

- 33700-17** Stanford Cade Insufflator, insufflator only, 175mm
- 33700-50** Stanford Cade Insufflator, bellows only
- 33700-90** Stanford Cade Insufflator, complete with bellows, 175mm

### Knot Tier and Pushers



- 33800-20** Negus Knot Tier And Pusher, 200mm

## Laryngeal Forceps

- 33900-30** Chevalier Jackson Laryngeal Grasping Forcep, alligator jaw, 300mm
- 33900-35** Chevalier Jackson Laryngeal Grasping Forcep, alligator jaw, 350mm
- 33900-40** Chevalier Jackson Laryngeal Grasping Forcep, alligator jaw, 400mm
- 33900-45** Chevalier Jackson Laryngeal Grasping Forcep, alligator jaw, 450mm
- 33900-55** Chevalier Jackson Laryngeal Grasping Forcep, alligator jaw, 550mm

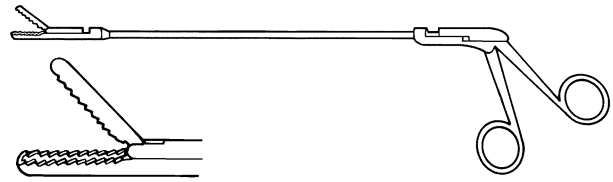

- 33910-30** Chevalier Jackson Laryngeal Grasping Forcep, flat serrated jaws, 300mm effective

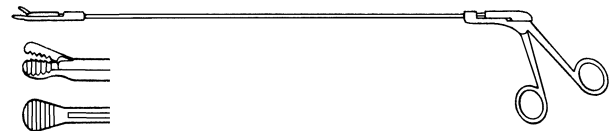

- 33920-30** Irwin Moore Laryngeal Forcep, alligator jaw, tenaculum points, 300mm
- 33920-35** Irwin Moore Laryngeal Forcep, alligator jaw, tenaculum points, 350mm
- 33920-40** Irwin Moore Laryngeal Forcep, alligator jaw, tenaculum points, 400mm
- 33920-55** Irwin Moore Laryngeal Forcep, alligator jaw, tenaculum points, 550mm

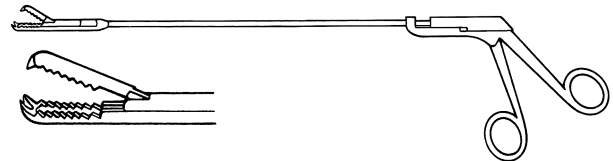

## Laryngeal Instruments

- 34000-14** Laryngeal Suction Tube, 260mm, 14swg

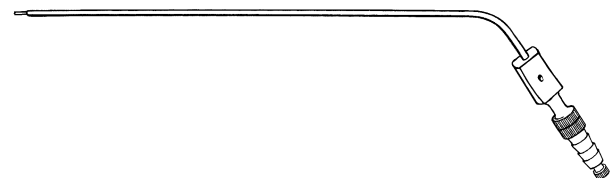

## Loops

- 34405-12** Gardiner Brown Imray Loop And Hook, double ended, 125mm



- 34420-12** Imray Loop, for removing hard wax, 125mm



## Mirrors

- 34500-95** Laryngeal Mirror, s/s handle only, 95mm

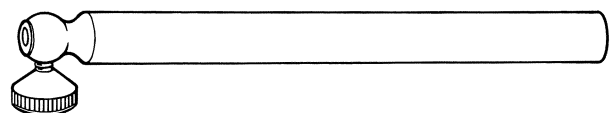

## Mirrors

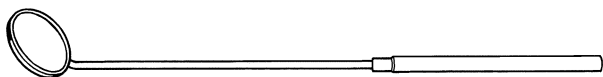

- 34510-06** Laryngeal Mirror, with s/s handle, 6mm diameter
- 34510-08** Laryngeal Mirror, with s/s handle, 8mm diameter
- 34510-10** Laryngeal Mirror, with s/s handle, 10mm diameter
- 34510-12** Laryngeal Mirror, with s/s handle, 12mm diameter
- 34510-14** Laryngeal Mirror, with s/s handle, 14mm diameter
- 34510-16** Laryngeal Mirror, with s/s handle, 16mm diameter
- 34510-18** Laryngeal Mirror, with s/s handle, 18mm diameter
- 34510-20** Laryngeal Mirror, with s/s handle, 20mm diameter
- 34510-22** Laryngeal Mirror, with s/s handle, 22mm diameter
- 34510-24** Laryngeal Mirror, with s/s handle, 24mm diameter
- 34510-26** Laryngeal Mirror, with s/s handle, 26mm diameter
- 34510-28** Laryngeal Mirror, with s/s handle, 28mm diameter
- 34510-30** Laryngeal Mirror, with s/s handle, 30mm diameter

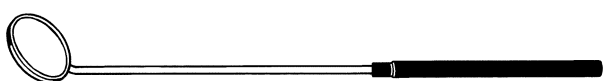

- 34515-06** Laryngeal Mirror, with black nylon handle, 6mm diameter
- 34515-08** Laryngeal Mirror, with black nylon handle, 8mm diameter
- 34515-10** Laryngeal Mirror, with black nylon handle, 10mm diameter
- 34515-12** Laryngeal Mirror, with black nylon handle, 12mm diameter
- 34515-14** Laryngeal Mirror, with black nylon handle, 14mm diameter
- 34515-16** Laryngeal Mirror, with black nylon handle, 16mm diameter
- 34515-18** Laryngeal Mirror, with black nylon handle, 18mm diameter
- 34515-20** Laryngeal Mirror, with black nylon handle, 20mm diameter
- 34515-22** Laryngeal Mirror, with black nylon handle, 22mm diameter
- 34515-24** Laryngeal Mirror, with black nylon handle, 24mm diameter
- 34515-26** Laryngeal Mirror, with black nylon handle, 26mm diameter
- 34515-28** Laryngeal Mirror, with black nylon handle, 28mm diameter
- 34515-30** Laryngeal Mirror, with black nylon handle, 30mm diameter

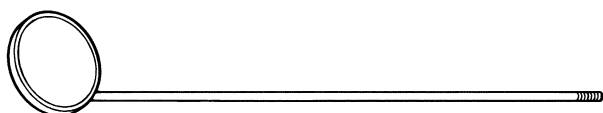

- 34520-06** Laryngeal Mirror, without handle, 6mm diameter
- 34520-08** Laryngeal Mirror, without handle, 8mm diameter
- 34520-10** Laryngeal Mirror, without handle, 10mm diameter
- 34520-12** Laryngeal Mirror, without handle, 12mm diameter
- 34520-14** Laryngeal Mirror, without handle, 14mm diameter
- 34520-16** Laryngeal Mirror, without handle, 16mm diameter
- 34520-18** Laryngeal Mirror, without handle, 18mm diameter
- 34520-20** Laryngeal Mirror, without handle, 20mm diameter
- 34520-22** Laryngeal Mirror, without handle, 22mm diameter
- 34520-24** Laryngeal Mirror, without handle, 24mm diameter
- 34520-26** Laryngeal Mirror, without handle, 26mm diameter
- 34520-28** Laryngeal Mirror, without handle, 28mm diameter
- 34520-30** Laryngeal Mirror, without handle, 30mm diameter

- 34598-10** Davis-Boyle Mouth Gag, pad for frame only, adult, pack of 5
- 34598-20** Davis-Boyle Mouth Gag, pad for frame only, child, pack of 5
- 34600-10** Davis-Boyle Mouth Gag, frame only, adult
- 34600-20** Davis-Boyle Mouth Gag, frame only, child

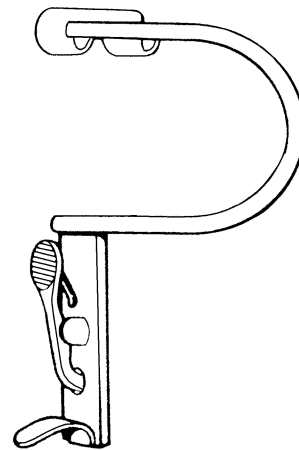

- 34610-06** Davis-Boyle Mouth Gag, tongue plate only, plain, 64mm
- 34610-07** Davis-Boyle Mouth Gag, tongue plate only, plain, 76mm
- 34610-08** Davis-Boyle Mouth Gag, tongue plate only, plain, 89mm
- 34610-10** Davis-Boyle Mouth Gag, tongue plate only, plain, 102mm
- 34610-11** Davis-Boyle Mouth Gag, tongue plate only, plain, 114mm

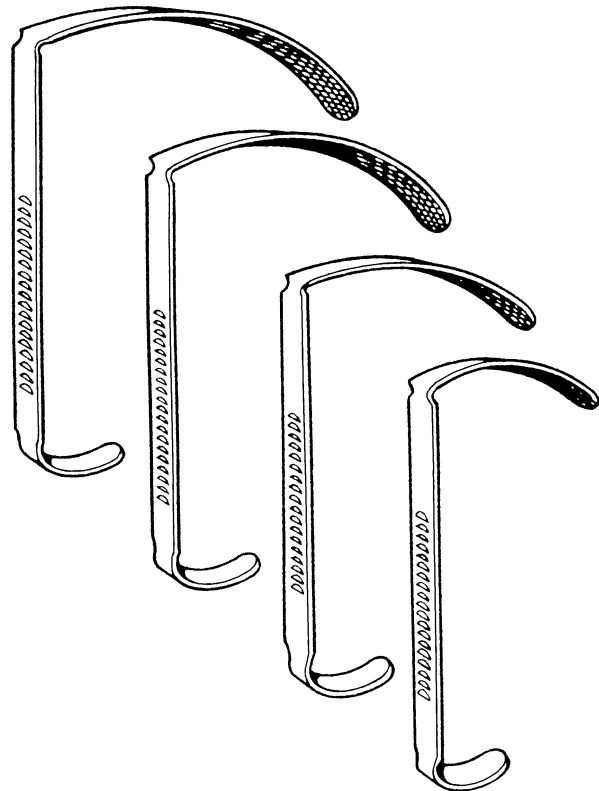

# Ear, Nose and Throat

## Mouth Gags

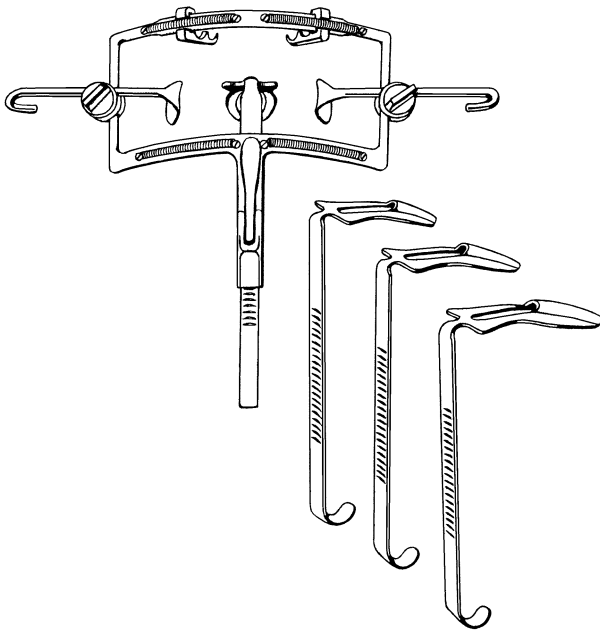

- 34620-10** Dingman Mouth Gag, tongue plate only, large
- 34620-20** Dingman Mouth Gag, tongue plate only, medium
- 34620-30** Dingman Mouth Gag, tongue plate only, small
- 34620-50** Dingman Mouth Gag, frame only
- 34620-90** Dingman Mouth Gag, complete, 1 frame and 3 tongue plates

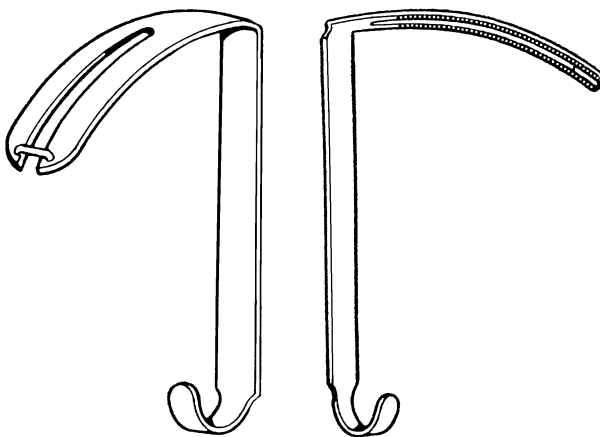

- 34630-06** Doughty Tongue Plate, for use with Davis-Boyle frame, slotted, 64mm
- 34630-07** Doughty Tongue Plate, for use with Davis-Boyle frame, slotted, 76mm
- 34630-08** Doughty Tongue Plate, for use with Davis-Boyle frame, slotted, 89mm
- 34630-10** Doughty Tongue Plate, for use with Davis-Boyle frame, slotted, 102mm
- 34630-11** Doughty Tongue Plate, for use with Davis-Boyle frame, slotted, 114mm

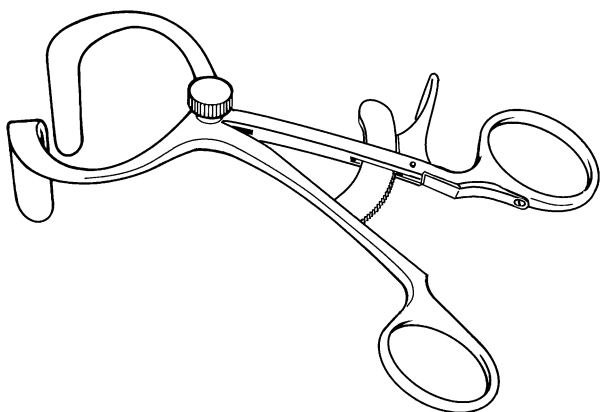

- 34640-10** Doyen Mouth Gag, adult
- 34640-20** Doyen Mouth Gag, child

## Mouth Gags

- 34650-10** Kilner Dott Mouth Gag, tongue plate only, with endotracheal tube groove, large
- 34650-20** Kilner Dott Mouth Gag, tongue plate only, with endotracheal tube groove, medium
- 34650-30** Kilner Dott Mouth Gag, tongue plate only, with endotracheal tube groove, small
- 34650-50** Kilner Dott Mouth Gag, frame only, adult
- 34650-60** Kilner Dott Mouth Gag, frame only, child
- 34650-90** Kilner Dott Mouth Gag, complete, 1 adult frame and 3 tongue plates

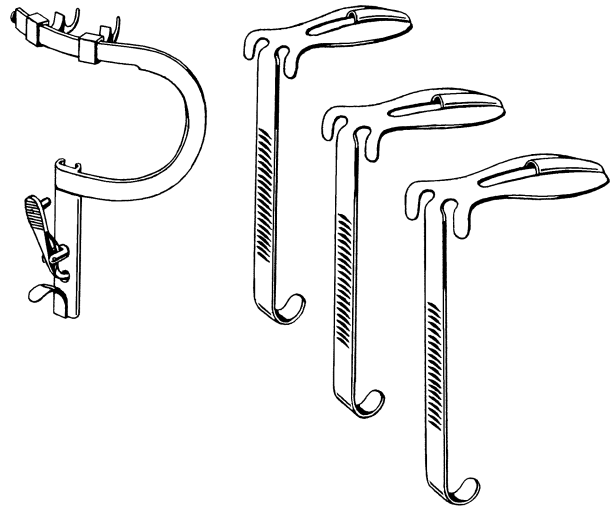

- 34660-10** Kilner Dott Mouth Gag, tongue plate only, insulated, with endotracheal tube groove, large
- 34660-20** Kilner Dott Mouth Gag, tongue plate only, insulated, with endotracheal tube groove, medium
- 34660-30** Kilner Dott Mouth Gag, tongue plate only, insulated, with endotracheal tube groove, small
- 34660-50** Kilner Dott Mouth Gag, frame only, adult, insulated
- 34660-90** Kilner Dott Mouth Gag, complete, insulated, 1 adult frame and 3 tongue plates

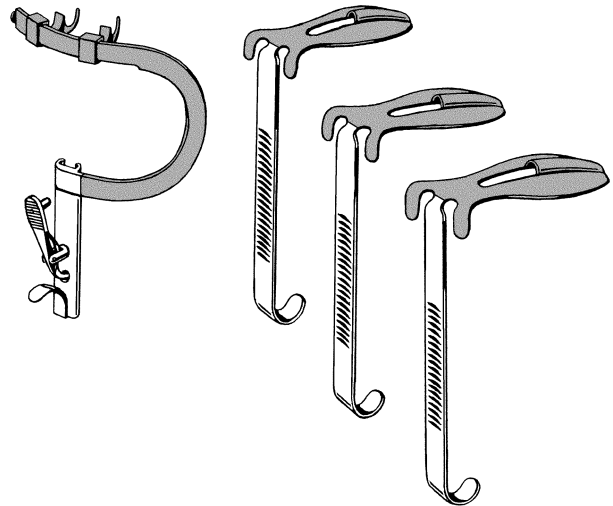

## Mouth Jacks

- 34700-10** Negus Mouth Jack, with rack action to raise and lower

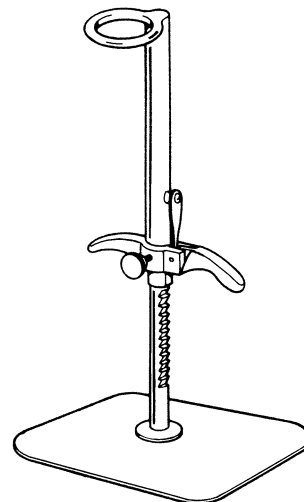

# Ear, Nose and Throat

## Myringotomes

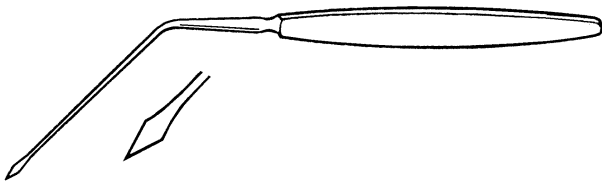

34800-19 Agnew Myringotome, 190mm

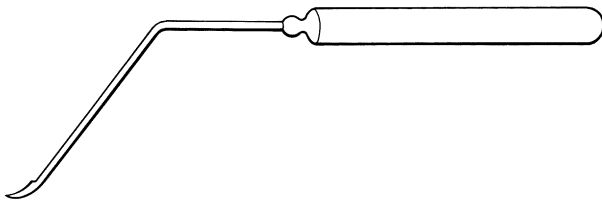

34805-15 Hallpike Myringotome, 150mm

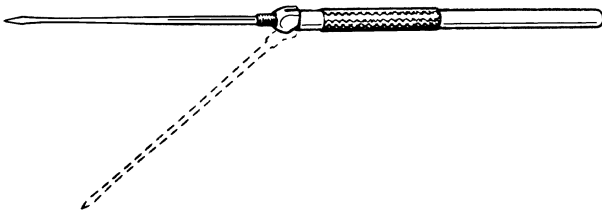

34810-17 Politzer Myringotome, reversing into handle, adjustable, 170mm

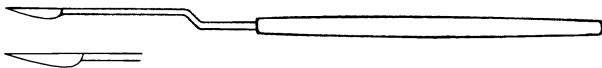

34820-17 Trautmann Myringotome, downward cutting, 175mm

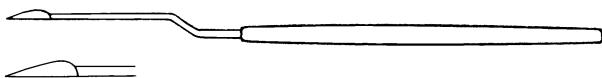

34830-17 Trautmann Myringotome, upward cutting, 175mm

## Nasal Forceps

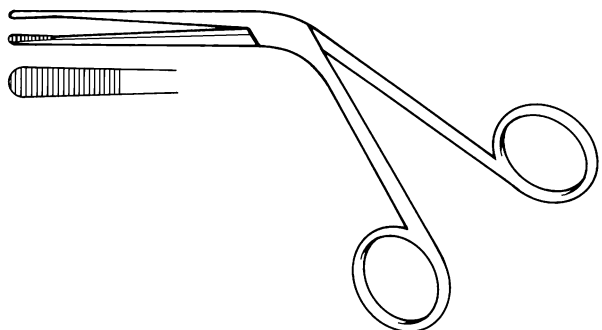

34900-16 Cawthorne Nasal Forcep, serrated, 165mm



## Nasal Forceps

**34910-17** Hartmann Nasal Forcep, serrated, screw joint, 175mm

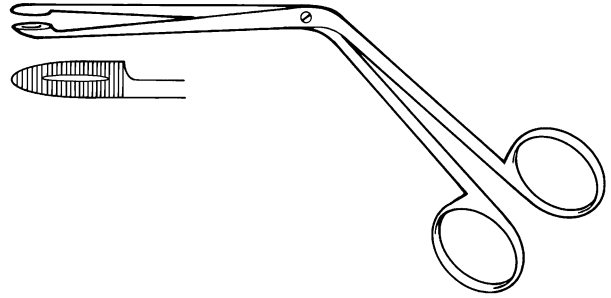

**34920-16** Lucae Nasal Forcep, serrated, 165mm



**34930-16** Tilley Nasal Forcep, serrated, fine tips, 165mm

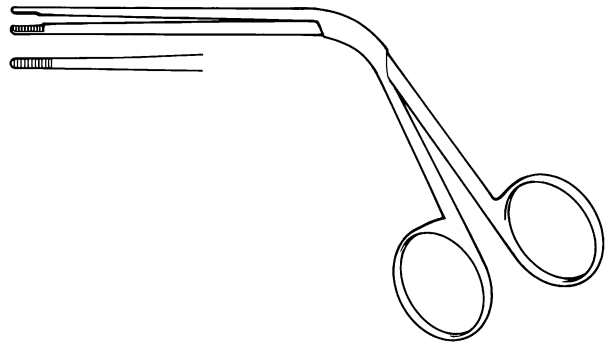

## Nasal Instruments

**35060-15** Cottle Alar Protector, 150mm

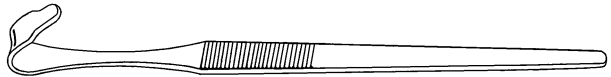

**35070-24** Cottle Periosteal Comb And Spicule Sweeper, 240mm

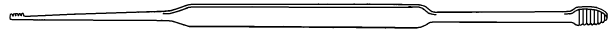

**35080-12** Cottle Tenaculum Hook, shallow curve, 125mm

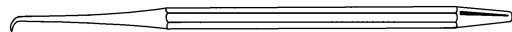

**35090-12** Cottle Tenaculum Hook, deep curve, 125mm



# Ear, Nose and Throat

## Nasal Instruments

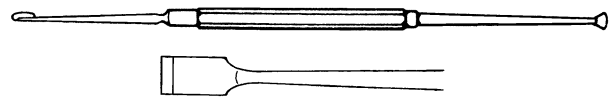

**35100-19** Freer Nasal Chisel, 190mm

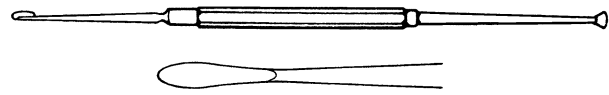

**35110-19** Freer Nasal Elevator, dull edge, 190mm

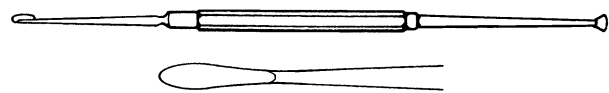

**35120-19** Freer Nasal Elevator, sharp edge, 190mm

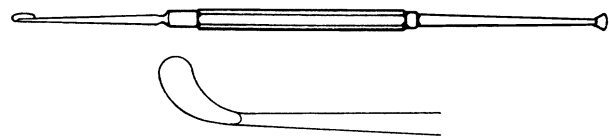

**35130-19** Freer Nasal Knife, curved to side, 190mm

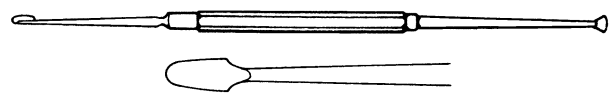

**35140-19** Freer Nasal Knife, flat rounded blade, 190mm

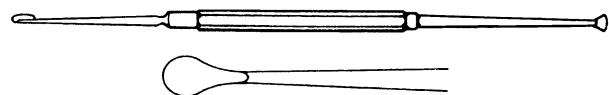

**35150-19** Freer Nasal Knife, rounded blade, curved on flat, 190mm

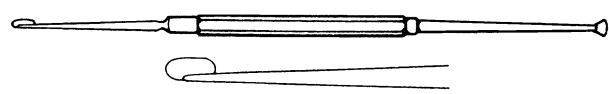

**35160-19** Freer Nasal Knife, rounded edge, 190mm

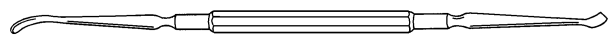

**35165-19** Freer Nasal Separator And Elevator, double ended, 190mm



**35170-35** House Measuring Rods, black finish, 160mm, 3.5mm



**35170-40** House Measuring Rods, black finish, 160mm, 4.0mm

## Nasal Instruments

**35170-45** House Measuring Rods, black finish, 160mm, 4.5mm



**35170-50** House Measuring Rods, black finish, 160mm, 5.0mm



**35180-16** Hughes Stapes Mobiliser, 165mm



## Nasal Knives

**35200-06** Ballenger Nasal Knife, cranked, 225mm, 6mm wide overall, head 55mm long

**35200-08** Ballenger Nasal Knife, cranked, 225mm, 8mm wide overall, head 55mm long

**35205-06** Ballenger Nasal Knife, cranked, 210mm, 6mm wide overall, head 40mm long

**35205-07** Ballenger Nasal Knife, cranked, 210mm, 7mm wide overall, head 40mm long

**35205-08** Ballenger Nasal Knife, cranked, 210mm, 8mm wide overall, head 40mm long



**35210-06** Ballenger Nasal Knife, straight, 200mm, 6mm wide overall, head 55mm long

**35210-08** Ballenger Nasal Knife, straight, 200mm, 8mm wide overall, head 55mm long

**35215-06** Ballenger Nasal Knife, straight, 185mm, 6mm wide overall, head 40mm long

**35215-07** Ballenger Nasal Knife, straight, 185mm, 7mm wide overall, head 40mm long

**35215-08** Ballenger Nasal Knife, straight, 185mm, 8mm wide overall, head 40mm long



## Nasal Rasps

**35300-10** Watson-Williams Nasal Rasp, rounded with convex blade, fine, 170mm

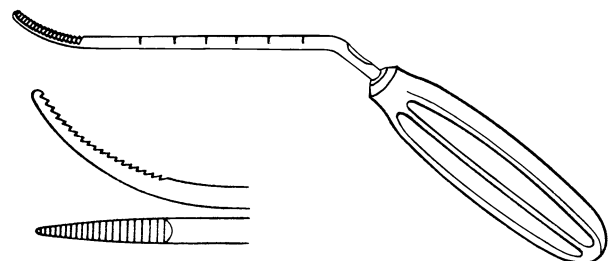

# Ear, Nose and Throat

## Nasal Raspers

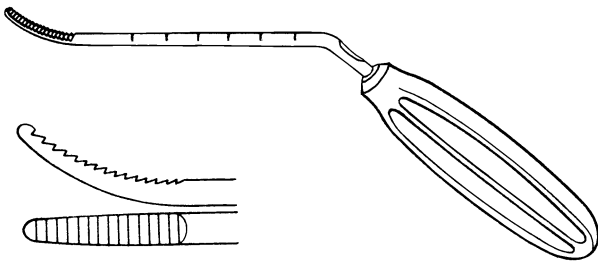

**35300-20** Watson-Williams Nasal Rasp, rounded with convex blade, heavy, 170mm

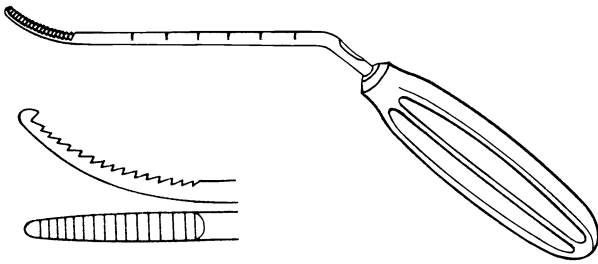

**35300-30** Watson-Williams Nasal Rasp, rounded with convex blade, light, 170mm

## Nasal Snares

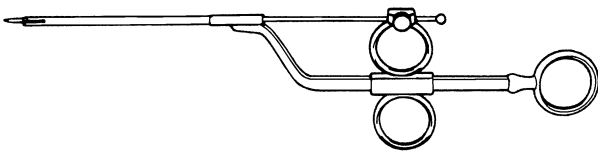

**35400-23** Glegg Nasal Snare, self-forming, 235mm

**35400-50** Glegg Nasal Snare, spare wire loop only, 30swg, pack of 10

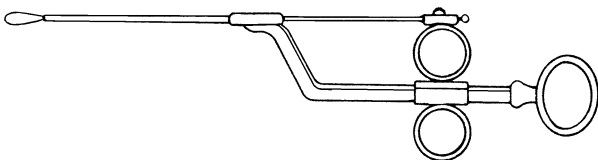

**35410-22** Negus Nasal Snare, 225mm

**35410-50** Negus Nasal Snare, spare wire loop only, 28swg, pack of 10

## Nasal Specula

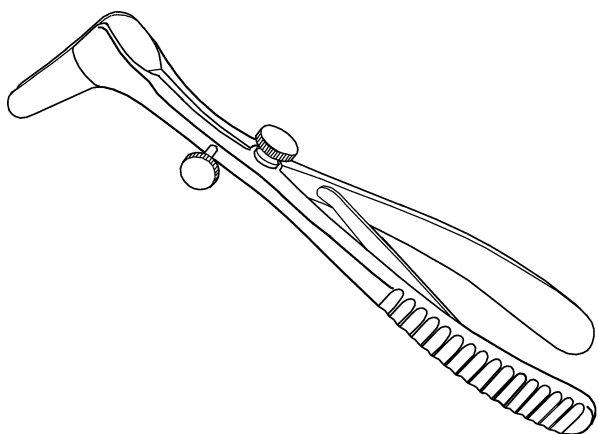

**35500-20** Cottle Nasal Speculum, blade 20mm

**35500-32** Cottle Nasal Speculum, blade 32mm

**35500-41** Cottle Nasal Speculum, blade 41mm

**35500-60** Cottle Nasal Speculum, blade 60mm

## Nasal Specula

- 35510-55** Killian Nasal Speculum, insulated, blade 55mm
- 35510-65** Killian Nasal Speculum, insulated, blade 65mm
- 35510-75** Killian Nasal Speculum, insulated, blade 75mm
- 35510-90** Killian Nasal Speculum, insulated, blade 90mm

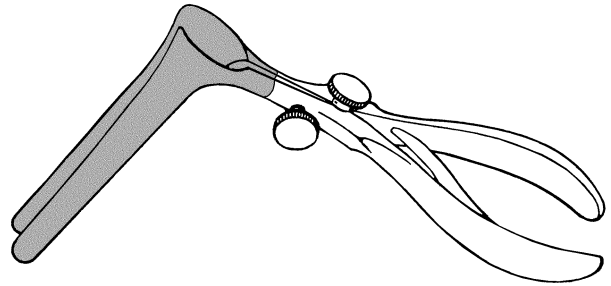

- 35520-55** Killian Nasal Speculum, plain, blade 55mm
- 35520-65** Killian Nasal Speculum, plain, blade 65mm
- 35520-75** Killian Nasal Speculum, plain, blade 75mm
- 35520-90** Killian Nasal Speculum, plain, blade 90mm

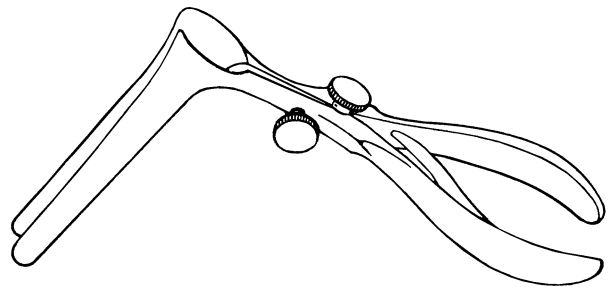

- 35525-55** Killian Nasal Speculum, with fibrelight, blade 55mm
- 35525-65** Killian Nasal Speculum, with fibrelight, blade 65mm
- 35525-75** Killian Nasal Speculum, with fibrelight, blade 75mm
- 35525-90** Killian Nasal Speculum, with fibrelight, blade 90mm

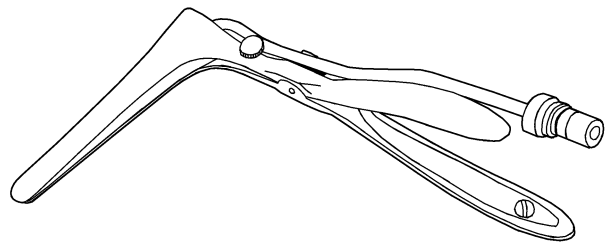

- 35529-10** Shah Nasal Speculum, left
- 35529-20** Shah Nasal Speculum, right

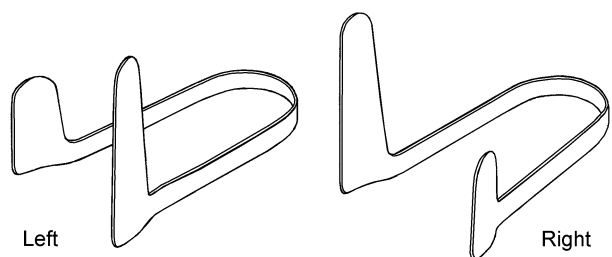

Left

Right

- 35530-10** Shah Nasal Speculum, insulated, left
- 35530-20** Shah Nasal Speculum, insulated, right

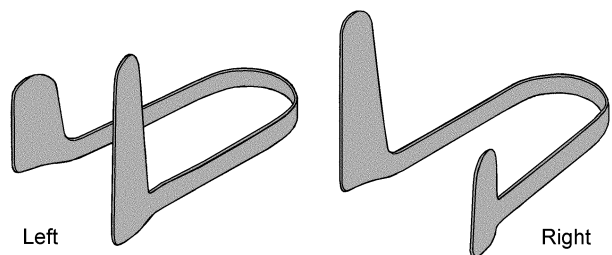

Left

Right

## Nasal Specula

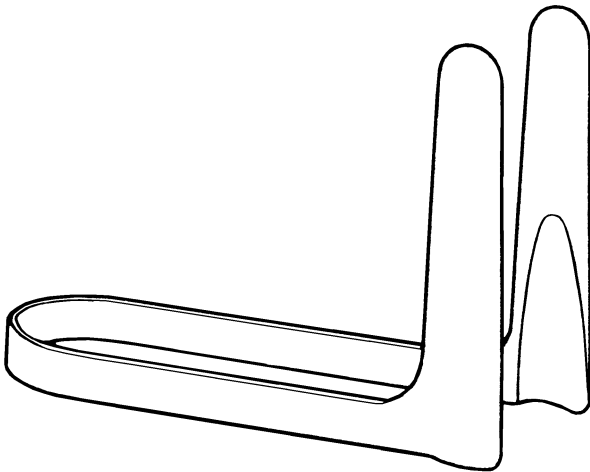

- 35540-38** St.Clair Thomson Nasal Speculum, blade 38mm
- 35540-50** St.Clair Thomson Nasal Speculum, blade 50mm
- 35540-65** St.Clair Thomson Nasal Speculum, blade 65mm
- 35540-75** St.Clair Thomson Nasal Speculum, blade 75mm
- 35540-90** St.Clair Thomson Nasal Speculum, set of 4

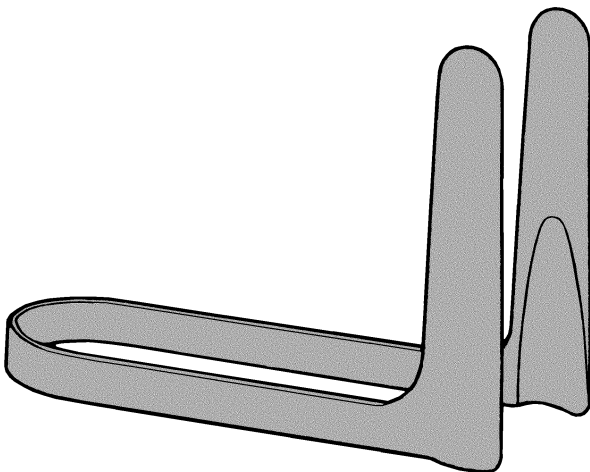

- 35545-38** St.Clair Thomson Nasal Speculum, insulated, blade 38mm
- 35545-50** St.Clair Thomson Nasal Speculum, insulated, blade 50mm
- 35545-65** St.Clair Thomson Nasal Speculum, insulated, blade 65mm
- 35545-75** St.Clair Thomson Nasal Speculum, insulated, blade 75mm
- 35545-90** St.Clair Thomson Nasal Speculum, insulated, set of 4

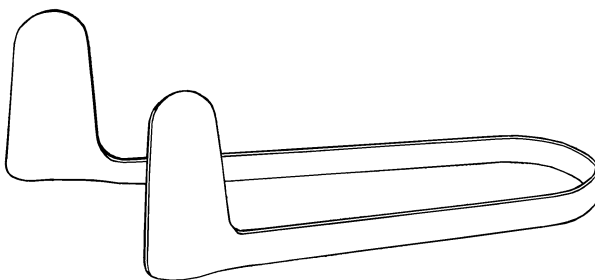

- 35550-10** Thudichum Nasal Speculum, 70mm, size 1, 12mm deep blade
- 35550-20** Thudichum Nasal Speculum, 70mm, size 2, 14mm deep blade
- 35550-30** Thudichum Nasal Speculum, 70mm, size 3, 16mm deep blade
- 35550-40** Thudichum Nasal Speculum, 70mm, size 4, 18mm deep blade
- 35550-50** Thudichum Nasal Speculum, 70mm, size 5, 20mm deep blade
- 35550-60** Thudichum Nasal Speculum, 70mm, size 6, 22mm deep blade
- 35550-70** Thudichum Nasal Speculum, 70mm, size 7, 24mm deep blade
- 35550-80** Thudichum Nasal Speculum, 70mm, size 8, 27mm deep blade
- 35550-85** Thudichum Nasal Speculum, 70mm, set of 5, sizes 4 to 8
- 35550-90** Thudichum Nasal Speculum, 70mm, set of 7, sizes 1 to 7

## Nasal Specula

- 35560-10** Thudichum Nasal Speculum, insulated, 70mm, size 1, 12mm deep blade
- 35560-20** Thudichum Nasal Speculum, insulated, 70mm, size 2, 14mm deep blade
- 35560-30** Thudichum Nasal Speculum, insulated, 70mm, size 3, 16mm deep blade
- 35560-40** Thudichum Nasal Speculum, insulated, 70mm, size 4, 18mm deep blade
- 35560-50** Thudichum Nasal Speculum, insulated, 70mm, size 5, 20mm deep blade
- 35560-60** Thudichum Nasal Speculum, insulated, 70mm, size 6, 22mm deep blade
- 35560-70** Thudichum Nasal Speculum, insulated, 70mm, size 7, 24mm deep blade
- 35560-80** Thudichum Nasal Speculum, insulated, 70mm, size 8, 27mm deep blade
- 35560-85** Thudichum Nasal Speculum, insulated, 70mm, set of 5, sizes 4 to 8
- 35560-90** Thudichum Nasal Speculum, insulated, 70mm, set of 7, sizes 1 to 7

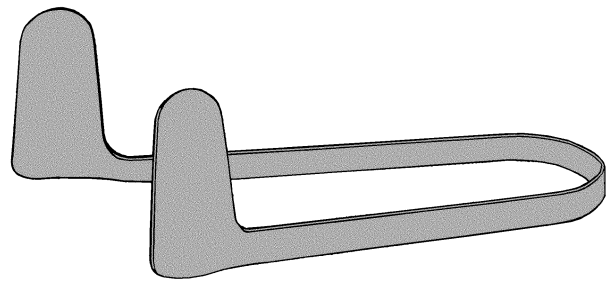

## Nibbling Forceps

- 35600-15** Lempert Nibbling Forcep, straight, screw joint, 150mm, 2.5mm jaw

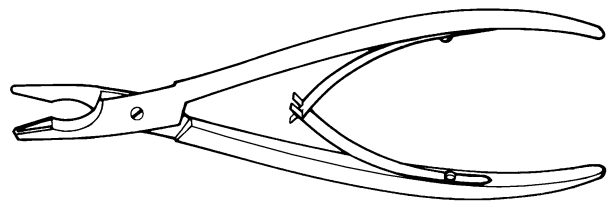

## Nodule Forceps

- 35700-28** Chevalier Jackson Vocal Nodule Forcep, upward cup, 280mm effective length
- 35700-35** Chevalier Jackson Vocal Nodule Forcep, upward cup, 350mm effective length
- 35700-40** Chevalier Jackson Vocal Nodule Forcep, upward cup, 400mm effective length
- 35700-50** Chevalier Jackson Vocal Nodule Forcep, upward cup, 500mm effective length
- 35700-55** Chevalier Jackson Vocal Nodule Forcep, upward cup, 550mm effective length

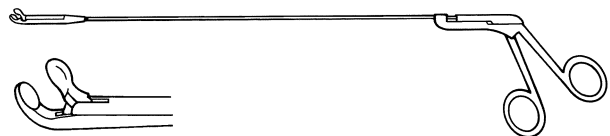

# Ear, Nose and Throat

## Palate Levers

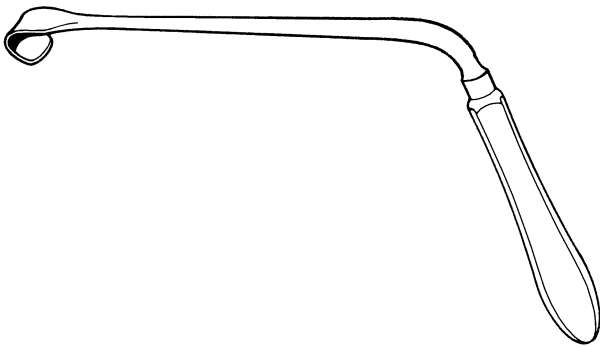

**35900-22** Angell James Palate Lever, 225mm

## Perforators

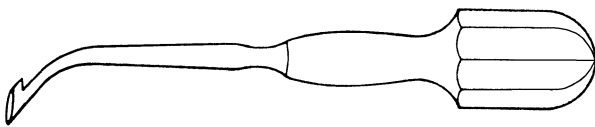

**36000-16** Myles Naso Antrum Perforator, 170mm, 16FG, 5.3mm

**36000-19** Myles Naso Antrum Perforator, 170mm, 19FG, 6.3mm

## Pituitary Forceps

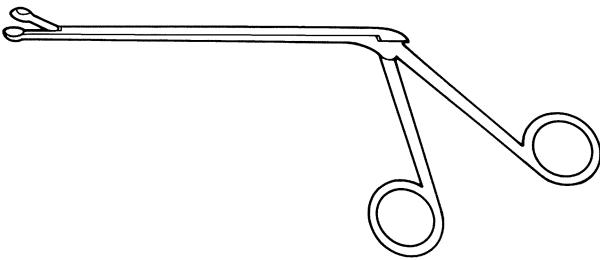

**36090-15** Bateman Pituitary Forcep, round cup, 5mm bite, fenestrated crocodile jaws, 150mm effective

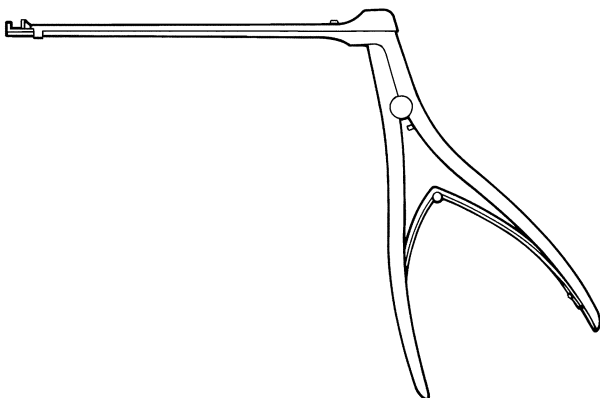

**36100-14** Wilson Pituitary Forcep, flattened tip, 3mm bite, 145mm effective

## Probes

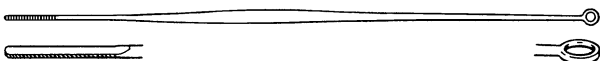

**36200-14** Jobson Horne Probe, double ended, 140mm

**36200-17** Jobson Horne Probe, double ended, 175mm



## Probes

**36210-13** Logan Turner Probe, 130mm

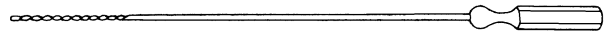

## Punch Forceps

**36300-15** Angell James Punch Forcep, downward cutting, 150mm, 2mm 60 degree bite

**36310-15** Angell James Punch Forcep, downward cutting, 150mm, 2mm right angled bite

**36320-15** Angell James Punch Forcep, upward cutting, 150mm, 2mm 60 degree bite

**36330-15** Angell James Punch Forcep, upward cutting, 150mm, 2mm right angle bite

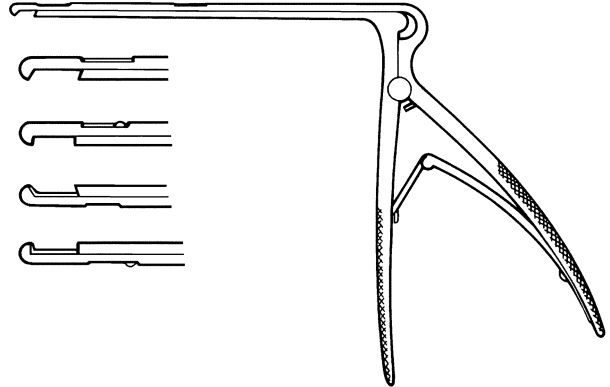

**36340-02** Citelli Antrum Punch Forcep, 73mm, 2mm bite

**36340-04** Citelli Antrum Punch Forcep, 75mm, 4mm bite

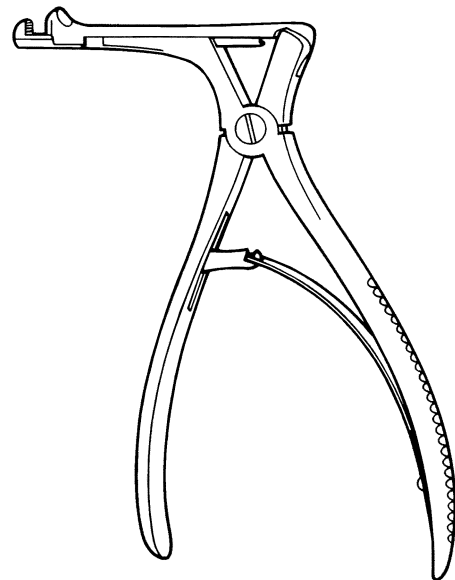

**36350-22** Ferris Smith Punch Forcep, downward cutting, black finish, 225mm, 5mm bite

**36360-22** Ferris Smith Punch Forcep, upward cutting, black finish, 225mm, 5mm bite

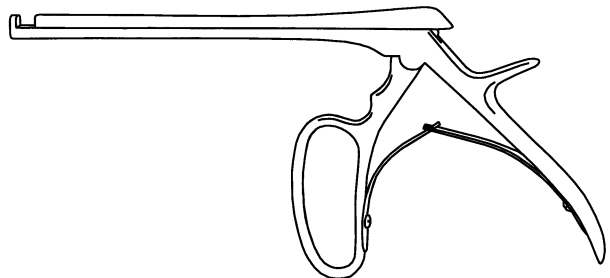

# Ear, Nose and Throat

## Punch Forceps

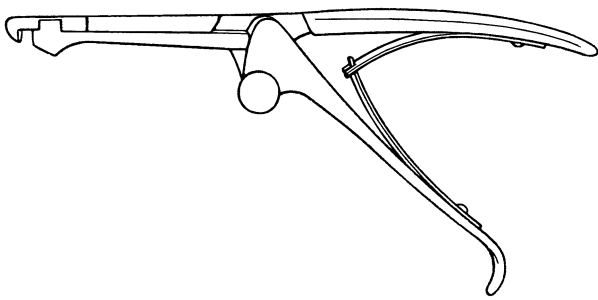

**36370-19** Hajek Antrum Punch Forcep, 195mm

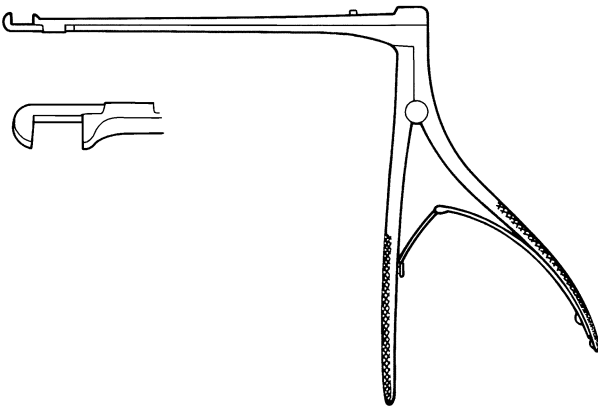

**36380-04** Hajek Sphenoidal Punch Forcep, downward cutting, 145mm, 4mm bite

**36380-05** Hajek Sphenoidal Punch Forcep, downward cutting, 145mm, 5mm bite

**36390-04** Hajek Sphenoidal Punch Forcep, upward cutting, 145mm, 4mm bite

**36390-05** Hajek Sphenoidal Punch Forcep, upward cutting, 145mm, 5mm bite

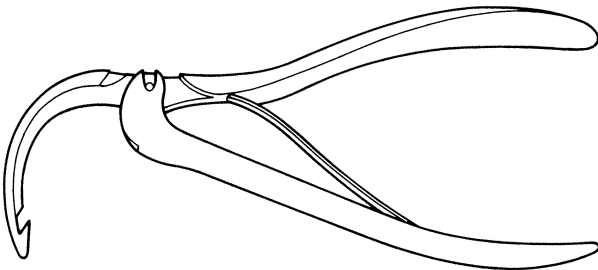

**36400-16** Seymour Jones Antrum Punch Forcep, 160mm

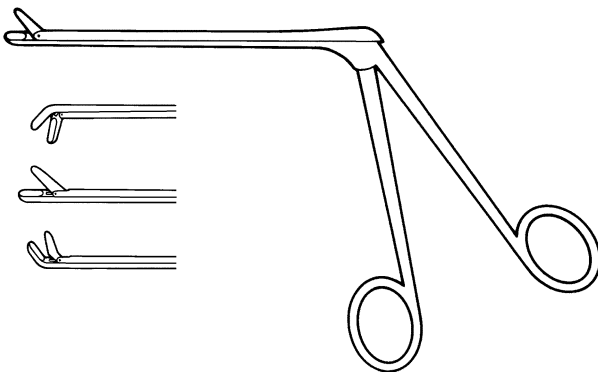

**36410-11** St. Bartholomews Ethmoid Punch Forcep, scoop blades, 112mm, downward cutting, 3mm bite

**36420-11** St. Bartholomews Ethmoid Punch Forcep, scoop blades, 112mm, straight, 3mm bite

**36430-11** St. Bartholomews Ethmoid Punch Forcep, scoop blades, 112mm, upward cutting, 3mm bite

## Punch Forceps

- 36440-45** Tilley Henckel Ethmoid Punch Forcep, 112mm, 4.5mm bite
- 36440-55** Tilley Henckel Ethmoid Punch Forcep, 112mm, 5.5mm bite
- 36440-65** Tilley Henckel Ethmoid Punch Forcep, 112mm, 6.5mm bite
- 36440-80** Tilley Henckel Ethmoid Punch Forcep, 112mm, 8.0mm bite

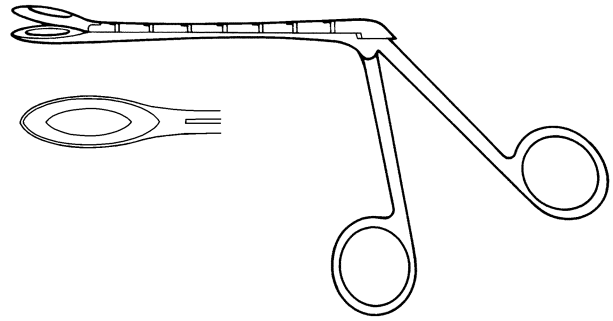

## Retractors

- 36500-16** Aufricht Retractor, 160mm

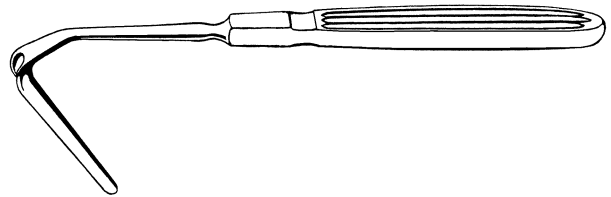

- 36510-18** Aufricht Retractor, with fibrelight, 180mm

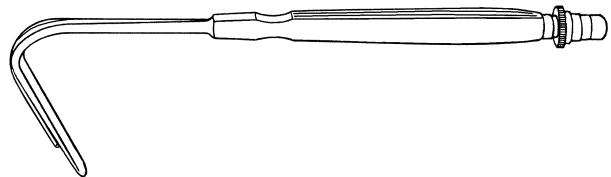

- 36520-14** Cottle Retractor, four prong, 140mm



- 36530-14** Cottle Retractor, two prong, blunt, 140mm

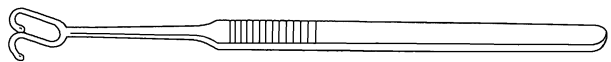

- 36540-14** Cottle Retractor, two prong, blunt/sharp, left, 140mm

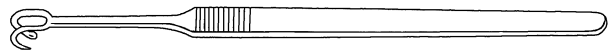

- 36550-14** Cottle Retractor, two prong, blunt/sharp, right, 140mm

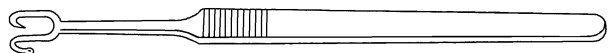

- 36560-19** Cottle Nievert Retractor, double ended, 190mm

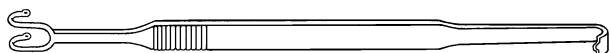

# Ear, Nose and Throat

## Retractors

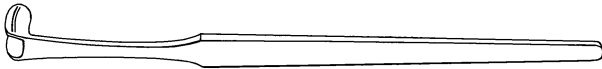

**36570-16** Cottle Upper Lateral Exposing Retractor, 160mm

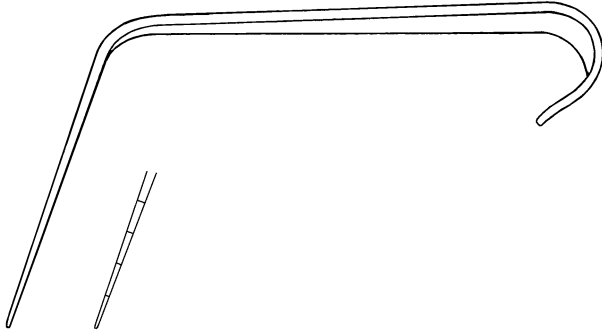

**36580-10** Cottle Retractor, single blade, graduated in cm, 110mm, No.1

**36580-20** Cottle Retractor, single blade, graduated in cm, 110mm, No.2

**36580-30** Cottle Retractor, single blade, graduated in cm, 110mm, No.3

**36580-40** Cottle Retractor, single blade, graduated in cm, 110mm, No.4

## Retractors - Self Retaining

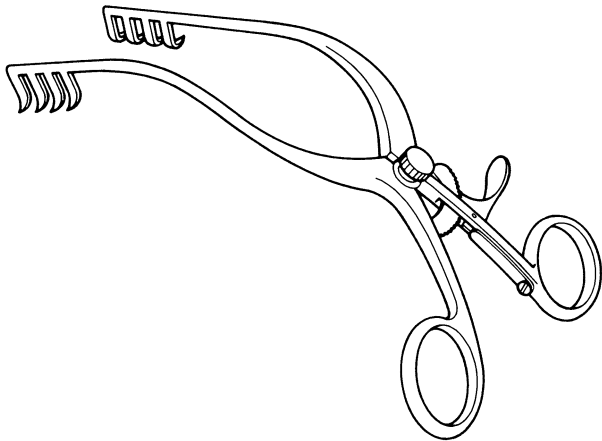

**36600-16** Mollison Self Retaining Retractor, curved, 4/4 teeth, 165mm

## Rugines



**36700-15** Lempert Rugine, narrow, 155mm



**36700-17** Lempert Rugine, broad, 170mm

**36800-70** Cawthorne Scissor, crocodile, black finish, extra fine, 70mm

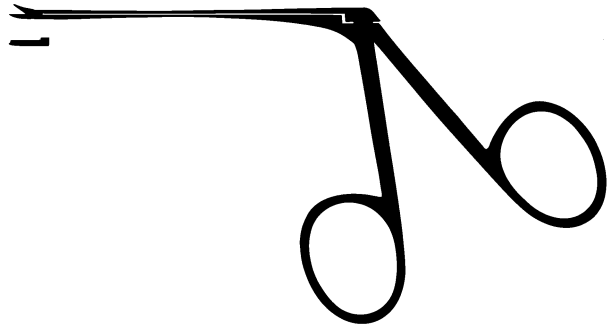

**36820-17** Knight (Heymann) Scissor, 175mm

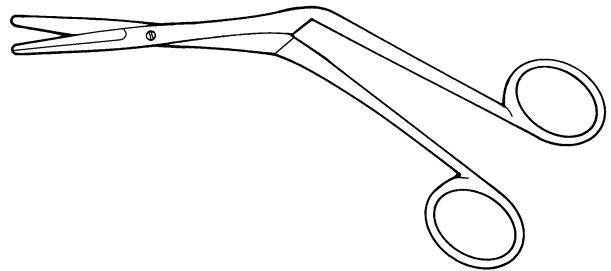

**36830-70** Ormerod Scissor, crocodile, black finish, extra fine, curved upwards, 70mm

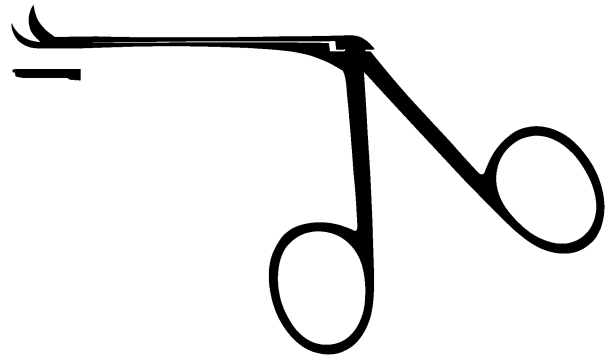

**36840-70** Portmann Scissor, crocodile, satin finish, 70mm, curved to the left

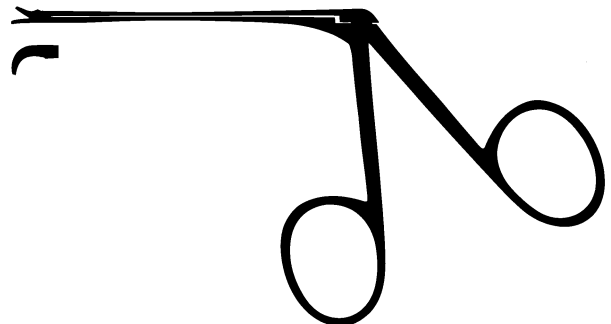

# Ear, Nose and Throat

## Scissors

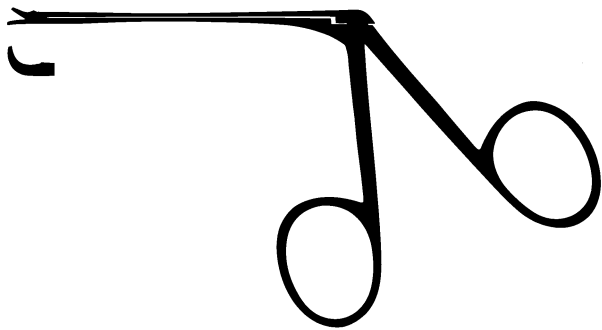

**36850-70** Portmann Scissor, crocodile, satin finish, 70mm, curved to the right

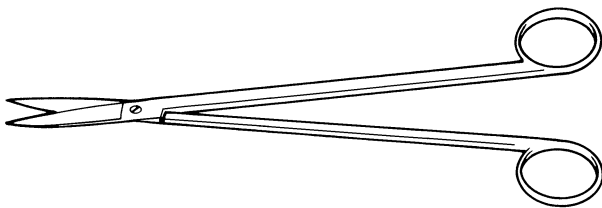

**36860-21** Scott Stevenson Tonsil Scissor, 215mm

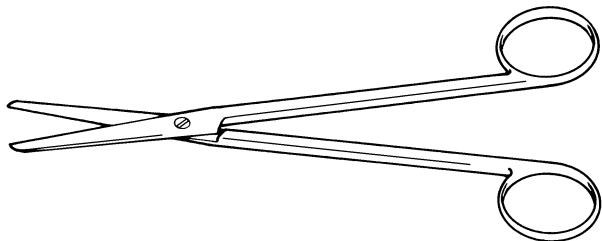

**36870-20** Wilson Tonsil Scissor, 200mm

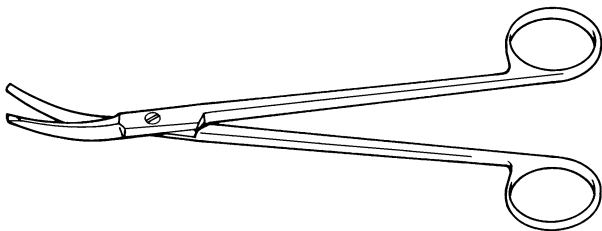

**36880-19** Woods Tonsil Scissor, 190mm

## Scoops

- 36900-02** Lempert Scoop, oval, 200mm, No.0000, 2.00mm x 3.5mm
- 36900-04** Lempert Scoop, oval, 200mm, No.000, 2.00mm x 4.0mm
- 36900-06** Lempert Scoop, oval, 200mm, No.00, 2.50mm x 4.5mm
- 36900-08** Lempert Scoop, oval, 200mm, No.0, 2.75mm x 5.0mm
- 36900-10** Lempert Scoop, oval, 200mm, No.1, 3.00mm x 5.5mm
- 36900-20** Lempert Scoop, oval, 200mm, No.2, 3.25mm x 6.0mm

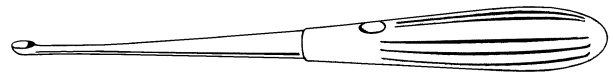

## Seekers

- 37000-15** Dundas-Grant Seeker, 150mm



## Skin Graft Plates

- 37050-15** Zoellner Skin Graft Plate, with holes 10mm, 29mm and 32mm, 150mm x 75mm

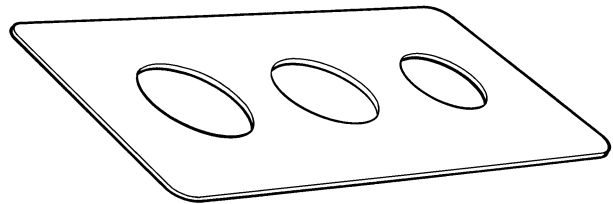

## Suction Tubes

- 37200-03** Barron Suction Tube, s/s, 225mm, 3FG, 1.0mm
- 37200-04** Barron Suction Tube, s/s, 225mm, 4FG, 1.3mm
- 37200-05** Barron Suction Tube, s/s, 225mm, 5FG, 1.6mm
- 37200-06** Barron Suction Tube, s/s, 225mm, 6FG, 2.0mm
- 37200-07** Barron Suction Tube, s/s, 225mm, 7FG, 2.3mm

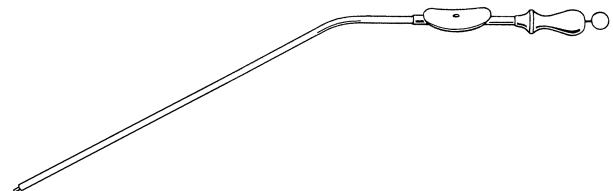

- 37210-06** Belluci Suction Tube, s/s, 6FG, with 3 ends

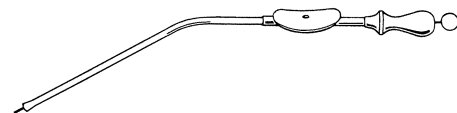

## Suction Tubes

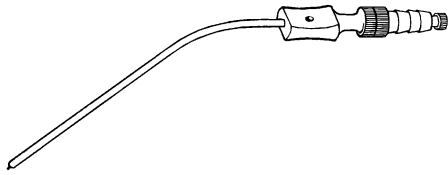

- 37214-15** Fergusson Suction Tube, s/s, 110mm working length, 1.5mm
- 37214-20** Fergusson Suction Tube, s/s, 110mm working length, 2.0mm
- 37214-25** Fergusson Suction Tube, s/s, 110mm working length, 2.5mm
- 37214-30** Fergusson Suction Tube, s/s, 110mm working length, 3.0mm
- 37214-40** Fergusson Suction Tube, s/s, 110mm working length, 4.0mm
- 37214-50** Fergusson Suction Tube, s/s, 110mm working length, 5.0mm

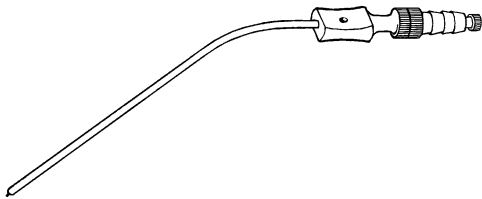

- 37215-15** Fergusson Suction Tube, s/s, 130mm working length, 1.5mm
- 37215-20** Fergusson Suction Tube, s/s, 130mm working length, 2.0mm
- 37215-25** Fergusson Suction Tube, s/s, 130mm working length, 2.5mm
- 37215-30** Fergusson Suction Tube, s/s, 130mm working length, 3.0mm
- 37215-40** Fergusson Suction Tube, s/s, 130mm working length, 4.0mm
- 37215-50** Fergusson Suction Tube, s/s, 130mm working length, 5.0mm

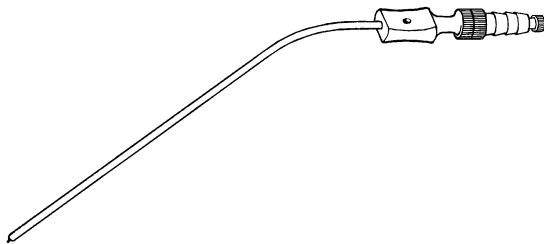

- 37216-15** Fergusson Suction Tube, s/s, 160mm working length, 1.5mm
- 37216-20** Fergusson Suction Tube, s/s, 160mm working length, 2.0mm
- 37216-25** Fergusson Suction Tube, s/s, 160mm working length, 2.5mm
- 37216-30** Fergusson Suction Tube, s/s, 160mm working length, 3.0mm
- 37216-40** Fergusson Suction Tube, s/s, 160mm working length, 4.0mm
- 37216-50** Fergusson Suction Tube, s/s, 160mm working length, 5.0mm

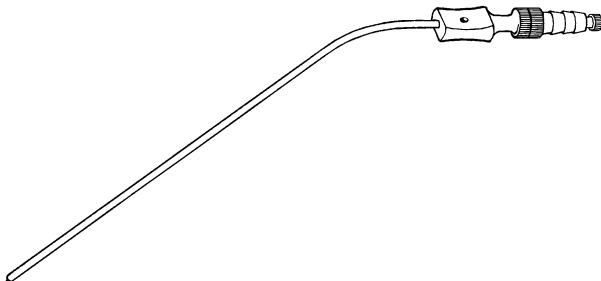

- 37217-15** Fergusson Suction Tube, s/s, 200mm working length, 1.5mm
- 37217-20** Fergusson Suction Tube, s/s, 200mm working length, 2.0mm
- 37217-25** Fergusson Suction Tube, s/s, 200mm working length, 2.5mm
- 37217-30** Fergusson Suction Tube, s/s, 200mm working length, 3.0mm
- 37217-40** Fergusson Suction Tube, s/s, 200mm working length, 4.0mm
- 37217-50** Fergusson Suction Tube, s/s, 200mm working length, 5.0mm



**37220-10** Formby Suction Tube, conical tip, 210mm, 10FG, 3.3mm

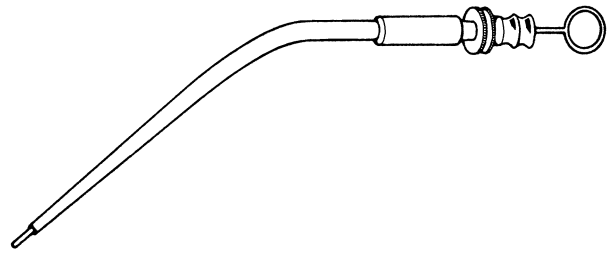

**37230-16** House Suction Tube, s/s, 125mm, 16swg - 18swg

**37230-18** House Suction Tube, s/s, 125mm, 18swg - 20swg

**37230-20** House Suction Tube, s/s, 125mm, 20swg - 22swg

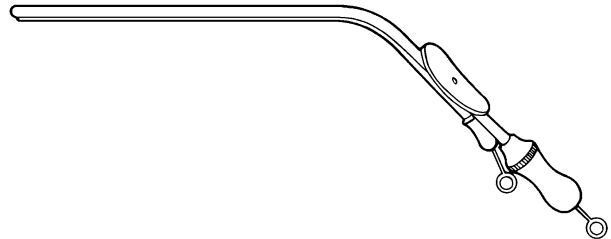

**37240-06** Lempert Suction Tube, s/s, with stilette, 200mm, 6FG, 2mm

**37240-09** Lempert Suction Tube, s/s, with stilette, 200mm, 9FG, 3mm

**37240-12** Lempert Suction Tube, s/s, with stilette, 200mm, 12FG, 4mm

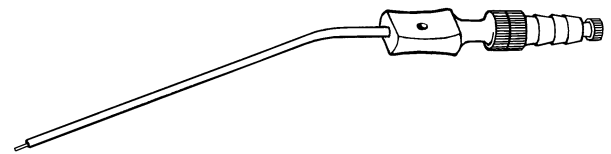

**37250-10** Magill Suction Tube, s/s, insulated, with stilette, 210mm, 3.0mm o.d., 1.0mm bore

**37250-20** Magill Suction Tube, s/s, insulated, with stilette, 210mm, 3.5mm o.d., 1.5mm bore

**37250-30** Magill Suction Tube, s/s, insulated, with stilette, 210mm, 4.0mm o.d., 2.0mm bore



# Ear, Nose and Throat

## Suction Tubes

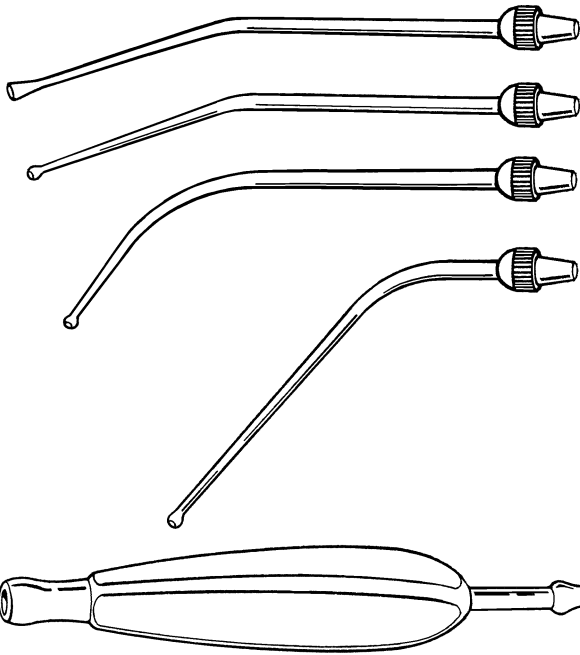

- 37260-10** Magill Universal Suction Tube, angled, 125mm, 3.5mm
- 37260-20** Magill Universal Suction Tube, angled, 125mm, 8.0mm
- 37260-30** Magill Universal Suction Tube, curved, 125mm, 8.0mm
- 37260-40** Magill Universal Suction Tube, deep angled, 125mm, 8.0mm
- 37260-50** Magill Universal Suction Tube, handle only
- 37260-90** Magill Universal Suction Tube, complete set of 4 suction tubes and handle

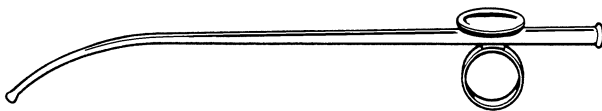

- 37270-10** Magill Suction Tube, s/s, with stilette, 210mm, 3.0mm o.d., 1.0mm bore
- 37270-15** Magill Suction Tube, s/s, with stilette, 210mm, 3.5mm o.d., 1.5mm bore
- 37270-20** Magill Suction Tube, s/s, with stilette, 210mm, 4.0mm o.d., 2.0mm bore
- 37270-50** Magill Suction Tube, s/s, stilette only

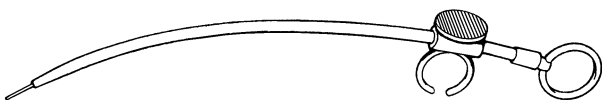

- 37280-28** Rowbotham Suction Tube, 285mm

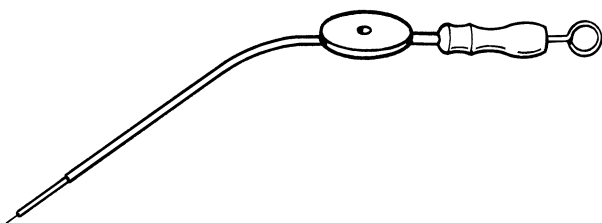

- 37285-20** Schuknecht Suction Tube, s/s, with stilette, 135mm, 20swg
- 37285-24** Schuknecht Suction Tube, s/s, with stilette, 135mm, 24swg

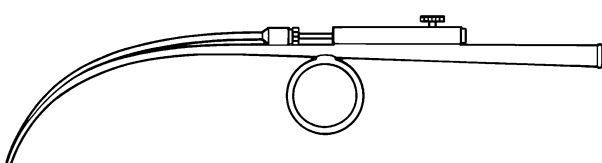

- 37290-15** Self-Clearing Suction Tube, 225mm, 1.5mm
- 37290-20** Self-Clearing Suction Tube, 225mm, 2.0mm
- 37290-30** Self-Clearing Suction Tube, 225mm, 3.0mm

## Suction Tubes

- 37300-16** Verhoeven Suction Tube, s/s, luer, 100mm, 16swg
- 37300-18** Verhoeven Suction Tube, s/s, luer, 100mm, 18swg
- 37300-20** Verhoeven Suction Tube, s/s, luer, 100mm, 20swg
- 37300-22** Verhoeven Suction Tube, s/s, luer, 100mm, 22swg
- 37300-24** Verhoeven Suction Tube, s/s, luer, 100mm, 24swg
- 37300-90** Verhoeven Suction Tube, s/s, luer, 100mm, set of 5

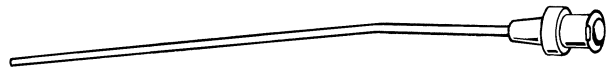

- 37310-18** Zoellner Suction Tube, s/s, detachable end only, 18swg
- 37310-20** Zoellner Suction Tube, s/s, detachable end only, 20swg
- 37310-22** Zoellner Suction Tube, s/s, detachable end only, 22swg
- 37310-24** Zoellner Suction Tube, s/s, detachable end only, 24swg
- 37310-26** Zoellner Suction Tube, s/s, detachable end only, 26swg
- 37310-90** Zoellner Suction Tube, s/s, detachable end only, set of 5, 18swg - 26swg



- 37320-17** Zoellner Suction Tube, s/s, tube with stilette, 175mm
- 37320-90** Zoellner Suction Tube, s/s, tube with stilette and set of 5 ends, 18swg to 26swg, 175mm

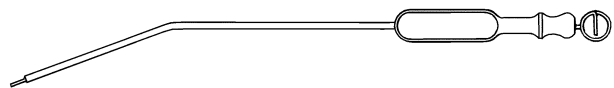

## Syringes

- 37410-92** Bacon Aural Syringe, complete, 920mm

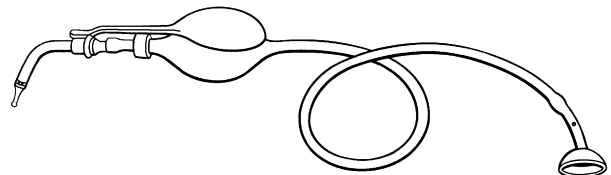

## Tongue Depressors

- 37500-18** Slightly Curved Tongue Depressor, tapered, 195mm, 14mm - 22mm
- 37505-15** Slightly Curved Tongue Depressor, parallel, child, 200mm, 15mm
- 37505-20** Slightly Curved Tongue Depressor, parallel, adult, 200mm, 20mm



## Ear, Nose and Throat

### Tongue Depressors

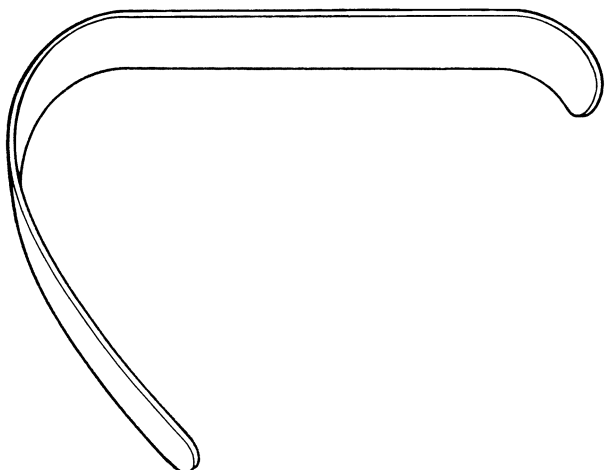

- 37510-12** Lack Tongue Depressor, child, 12mm
- 37510-19** Lack Tongue Depressor, adolescent, 19mm
- 37510-22** Lack Tongue Depressor, adult, 22mm

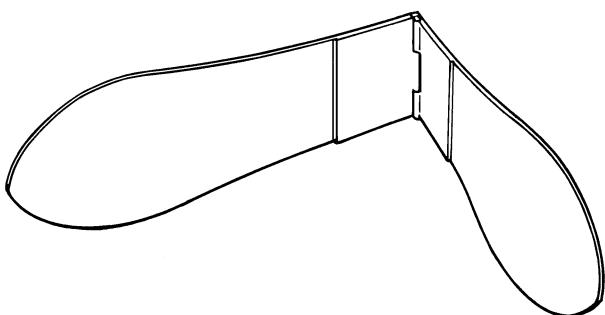

- 37520-10** Tobbold Tongue Depressor, folding, concave blades

### Tongue Forceps

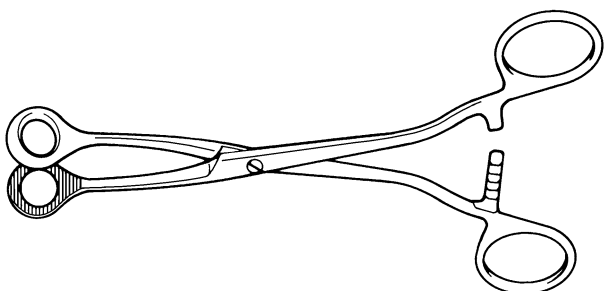

- 37600-16** Collin Tongue Forcep, screw joint, 160mm

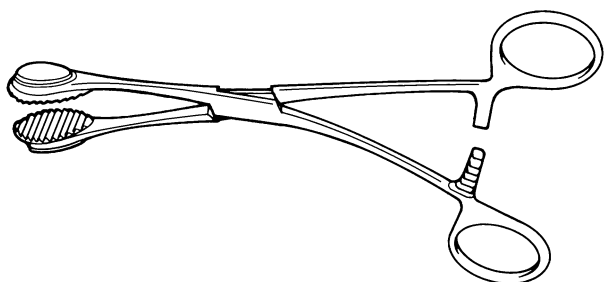

- 37610-17** Young Tongue Forcep, 170mm

## Tonsil Holding Forceps

- 37700-20** Denis Browne Tonsil Holding Forcep, with rack, 200mm
- 37710-20** Denis Browne Tonsil Holding Forcep, without rack, 200mm

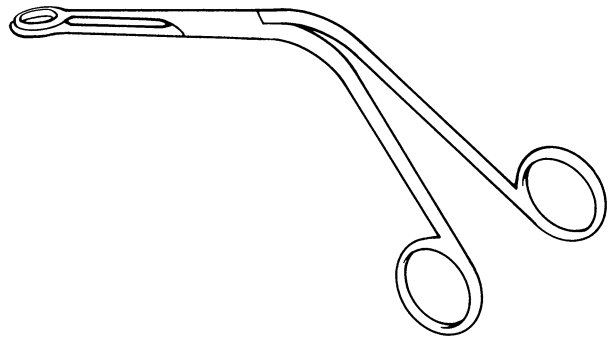

## Tonsil Snares

- 37900-27** Eve Tonsil Snare, s/s, without ratchet, 275mm
- 37900-50** Eve Tonsil Snare, s/s, spare wire loop only, 25swg, pack of 10

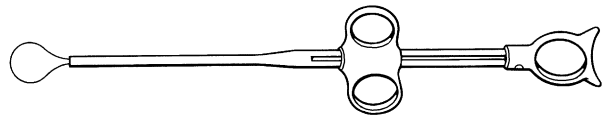

## Tracheal Dilators

- 38000-12** Trousseau Tracheal Dilator, child, 125mm

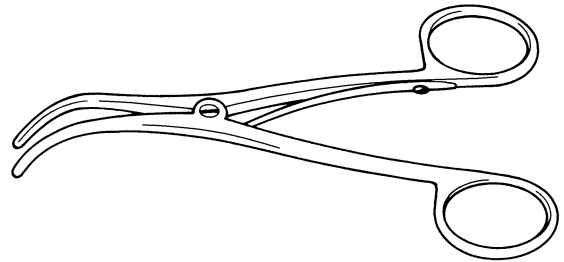

- 38000-14** Trousseau Tracheal Dilator, adult, 140mm

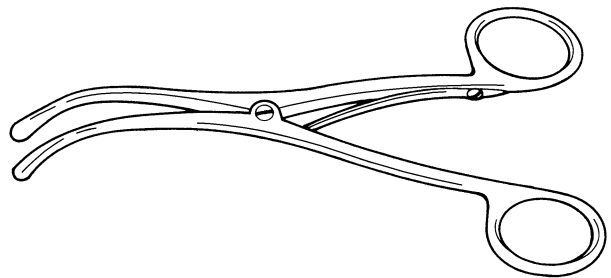

## Trocars

- 38100-17** Tilley Harpoon Trocar, 170mm

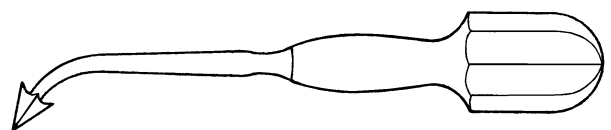

# Ear, Nose and Throat

## Trocars

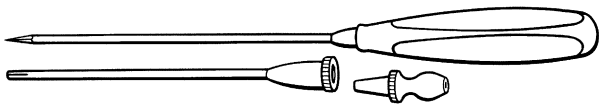

- 38110-05** Tilley Lichtwitz Trocar, s/s, cannula / tubing mount, luer fitting, 195mm, 5FG
- 38110-06** Tilley Lichtwitz Trocar, s/s, cannula / tubing mount, luer fitting, 195mm, 6FG
- 38110-07** Tilley Lichtwitz Trocar, s/s, cannula / tubing mount, luer fitting, 195mm, 7FG
- 38110-08** Tilley Lichtwitz Trocar, s/s, cannula / tubing mount, luer fitting, 195mm, 8FG
- 38110-09** Tilley Lichtwitz Trocar, s/s, cannula / tubing mount, luer fitting, 195mm, 9FG

## Turbinate Forceps

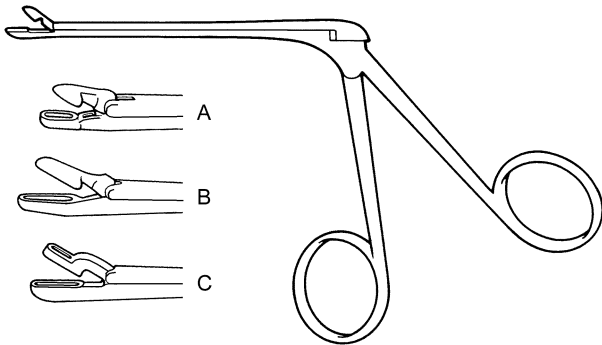

- 38300-10** Grunwald Turbinate Forcep, narrow punch jaws, 105mm, pattern A
- 38300-20** Grunwald Turbinate Forcep, narrow punch jaws, 105mm, pattern B
- 38300-30** Grunwald Turbinate Forcep, narrow punch jaws, 105mm, pattern C

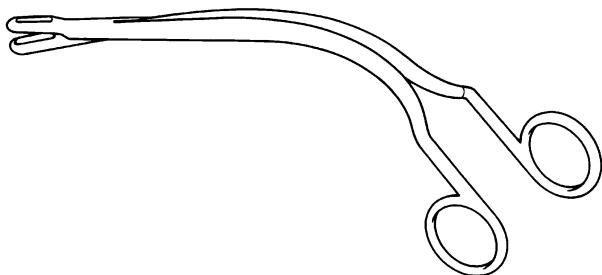

- 38310-19** Irwin Moore Turbinate Forcep, 190mm

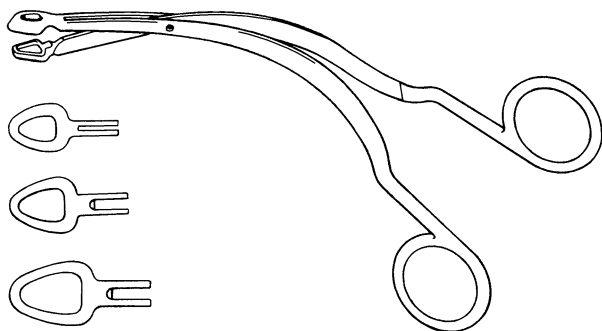

- 38320-06** Luc Turbinate Forcep, heart shaped, 175mm, 6mm
- 38320-07** Luc Turbinate Forcep, heart shaped, 175mm, 7.5mm
- 38320-09** Luc Turbinate Forcep, heart shaped, 175mm, 9mm

**Turbinate Forceps**

- 38330-06** Luc Turbinate Forcep, oval, 190mm, 6mm
- 38330-07** Luc Turbinate Forcep, oval, 190mm, 7.5mm
- 38330-09** Luc Turbinate Forcep, oval, 190mm, 9mm

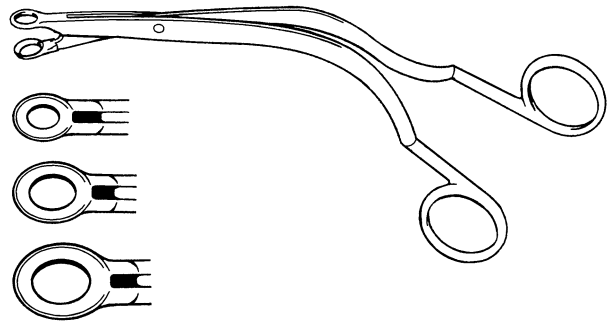

**Wool Carriers**

- 38400-17** Heath Wool Carrier, fine, 170mm

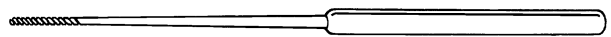

- 38410-17** Musgrove Wool Carrier, 170mm



- 38420-15** Tumarkin Wool Carrier, 150mm

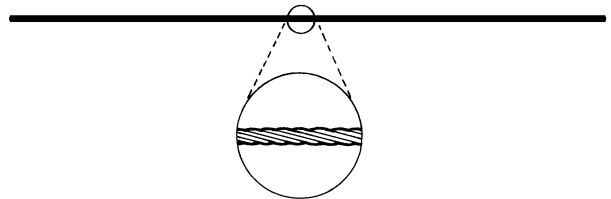

# Thoracic

## Artery Forceps

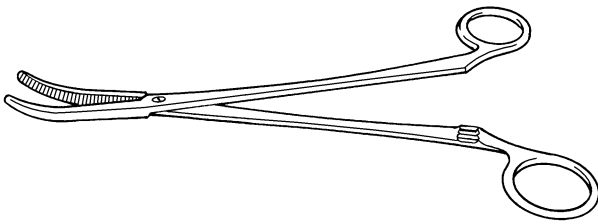

- 41000-23** Roberts Artery Forcep, curved on flat, box joint, 230mm
- 41010-23** Roberts Artery Forcep, curved on flat, screw joint, 230mm

## Biopsy Punches

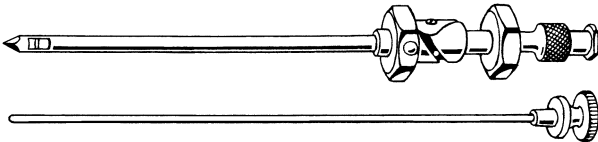

- 41100-12** Abrams Pleural Biopsy Punch, length 125mm, 4mm

## Clamps



- 41200-11** Blalock Clamp, cross action, curved, 11mm jaw
- 41200-14** Blalock Clamp, cross action, curved, 14mm jaw
- 41200-17** Blalock Clamp, cross action, curved, 17mm jaw
- 41200-27** Blalock Clamp, cross action, curved, 27mm jaw
- 41200-38** Blalock Clamp, cross action, curved, 38mm jaw



- 41210-11** Blalock Clamp, cross action, straight, 11mm jaw
- 41210-14** Blalock Clamp, cross action, straight, 14mm jaw
- 41210-17** Blalock Clamp, cross action, straight, 17mm jaw
- 41210-27** Blalock Clamp, cross action, straight, 27mm jaw
- 41210-38** Blalock Clamp, cross action, straight, 38mm jaw

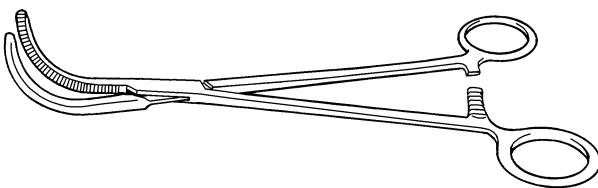

- 41250-24** Crafoord Clamp, medium curve, 240mm



- 41260-10** DeBakey-Dietrich Micro Bulldog Clamp, angled, 180g, 10mm jaw
- 41260-14** DeBakey-Dietrich Micro Bulldog Clamp, angled, 180g, 14mm jaw
- 41260-20** DeBakey-Dietrich Micro Bulldog Clamp, angled, 180g, 20mm jaw
- 41270-20** DeBakey-Dietrich Micro Bulldog Clamp, curved, 180g, 20mm jaw
- 41280-10** DeBakey-Dietrich Micro Bulldog Clamp, straight, 180g, 10mm jaw
- 41280-14** DeBakey-Dietrich Micro Bulldog Clamp, straight, 180g, 14mm jaw
- 41280-20** DeBakey-Dietrich Micro Bulldog Clamp, straight, 180g, 20mm jaw

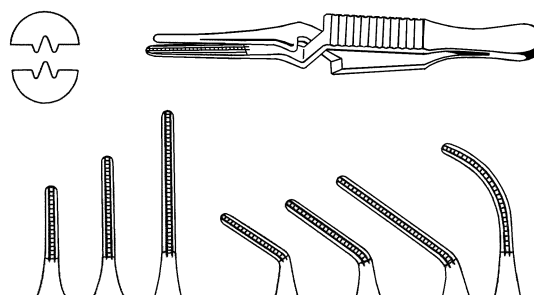

- 41290-08** Dietrich Micro Bulldog Clamp, angled, 180g, 8mm jaw
- 41290-12** Dietrich Micro Bulldog Clamp, angled, 180g, 12mm jaw
- 41290-16** Dietrich Micro Bulldog Clamp, angled, 180g, 16mm jaw
- 41290-20** Dietrich Micro Bulldog Clamp, angled, 180g, 20mm jaw
- 41300-08** Dietrich Micro Bulldog Clamp, angled, 80g, 8mm jaw
- 41300-12** Dietrich Micro Bulldog Clamp, angled, 80g, 12mm jaw
- 41300-16** Dietrich Micro Bulldog Clamp, angled, 80g, 16mm jaw
- 41300-20** Dietrich Micro Bulldog Clamp, angled, 80g, 20mm jaw

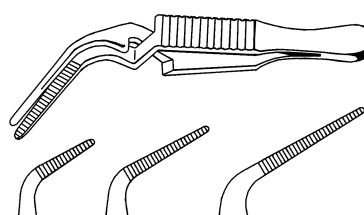

- 41310-08** Dietrich Micro Bulldog Clamp, straight, 180g, 8mm jaw
- 41310-12** Dietrich Micro Bulldog Clamp, straight, 180g, 12mm jaw
- 41310-16** Dietrich Micro Bulldog Clamp, straight, 180g, 16mm jaw
- 41310-20** Dietrich Micro Bulldog Clamp, straight, 180g, 20mm jaw
- 41320-08** Dietrich Micro Bulldog Clamp, straight, 80g, 8mm jaw
- 41320-12** Dietrich Micro Bulldog Clamp, straight, 80g, 12mm jaw
- 41320-16** Dietrich Micro Bulldog Clamp, straight, 80g, 16mm jaw
- 41320-20** Dietrich Micro Bulldog Clamp, straight, 80g, 20mm jaw

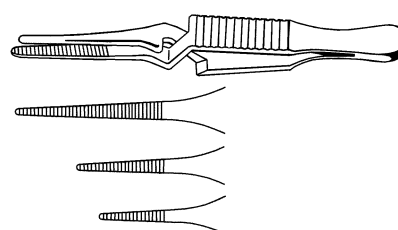

# Thoracic

## Costotomes

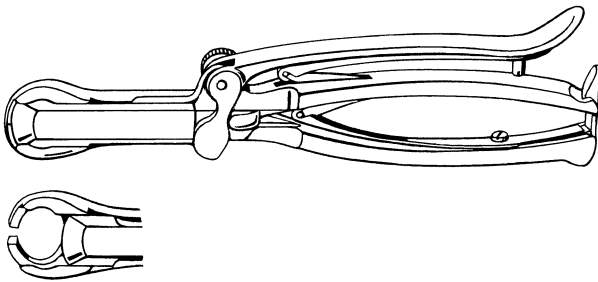

**41800-24** Vehmehren (Tudor Edwards) Costotome, 240mm

## Dilators

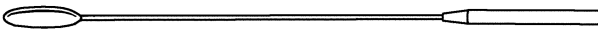

- 41850-05** DeBakey Vascular Dilator, malleable, 190mm, 0.5mm
- 41850-10** DeBakey Vascular Dilator, malleable, 190mm, 1.0mm
- 41850-15** DeBakey Vascular Dilator, malleable, 190mm, 1.5mm
- 41850-20** DeBakey Vascular Dilator, malleable, 190mm, 2.0mm
- 41850-25** DeBakey Vascular Dilator, malleable, 190mm, 2.5mm
- 41850-30** DeBakey Vascular Dilator, malleable, 190mm, 3.0mm
- 41850-35** DeBakey Vascular Dilator, malleable, 190mm, 3.5mm
- 41850-40** DeBakey Vascular Dilator, malleable, 190mm, 4.0mm
- 41850-45** DeBakey Vascular Dilator, malleable, 190mm, 4.5mm
- 41850-50** DeBakey Vascular Dilator, malleable, 190mm, 5.0mm
- 41850-70** DeBakey Vascular Dilator, malleable, 190mm, 7.0mm
- 41850-90** DeBakey Vascular Dilator, malleable, 190mm, 9.0mm
- 41850-95** DeBakey Vascular Dilator, malleable, 190mm, set of 12

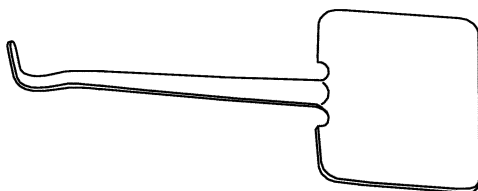

**41860-10** Hohn Vessel Dilator, for introducing catheters

## Dissecting Forceps

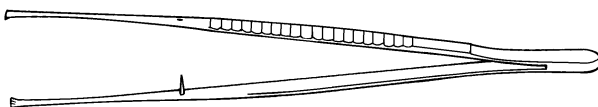

**41900-23** Nelson Dissecting Forcep, fine teeth, 230mm

## Elevators

- 42000-16** Doyen Periosteal Elevator, adult, 165mm, left  
**42020-16** Doyen Periosteal Elevator, child, 150mm, left

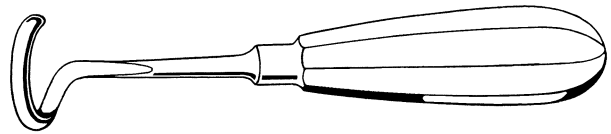

- 42010-16** Doyen Periosteal Elevator, adult, 165mm, right  
**42030-16** Doyen Periosteal Elevator, child, 150mm, right

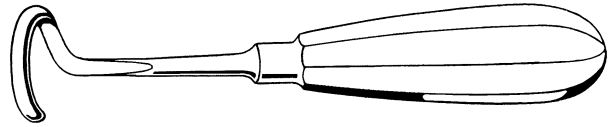

- 42040-12** Tudor Edwards Periosteal Elevator, 175mm, 12mm  
**42040-18** Tudor Edwards Periosteal Elevator, 175mm, 18mm

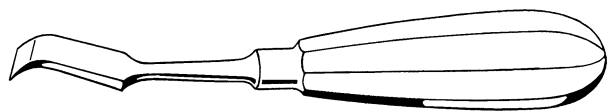

## Hooks

- 42100-24** Blalock Hook, right angled, 240mm



## Infusion Devices

- 42200-10** Tibbs Arterial Cannula, large cone  
**42200-20** Tibbs Arterial Cannula, large olive  
**42200-30** Tibbs Arterial Cannula, small cone  
**42200-40** Tibbs Arterial Cannula, small olive  
**42200-90** Tibbs Arterial Cannula, set of 4

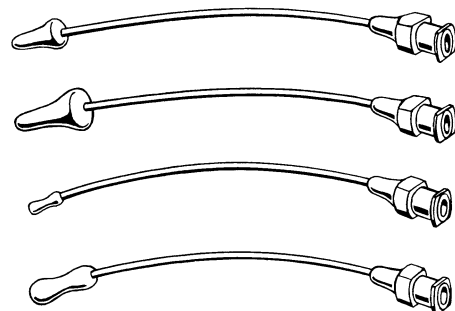

## Lung Forceps

- 42300-25** Duval Lung Forcep, 25mm blade, 220mm

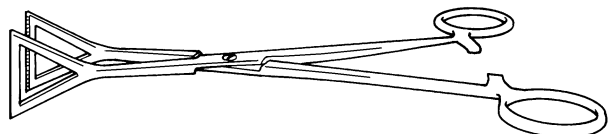

- 42310-22** Mayo Lung Forcep, fenestrated, 225mm



# Thoracic

## Perfusion

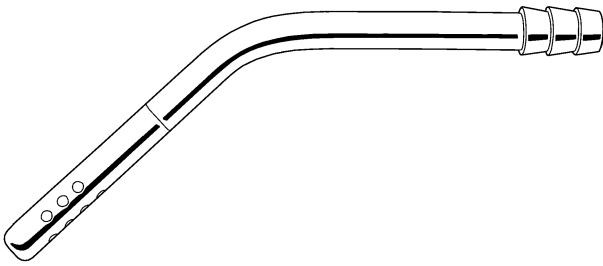

- 42350-40** Baylor Sump Sucker, screw apart, angled 90 degrees, infant, 4.0mm o.d.
- 42350-50** Baylor Sump Sucker, screw apart, angled 90 degrees, child, 5.0mm o.d.
- 42350-60** Baylor Sump Sucker, screw apart, angled 90 degrees, adult, 6.0mm o.d.
- 42351-40** Baylor Sump Sucker, screw apart, angled 45 degrees, infant, 4.0mm o.d.
- 42351-50** Baylor Sump Sucker, screw apart, angled 45 degrees, child, 5.0mm o.d.
- 42351-60** Baylor Sump Sucker, screw apart, angled 45 degrees, adult, 6.0mm o.d.

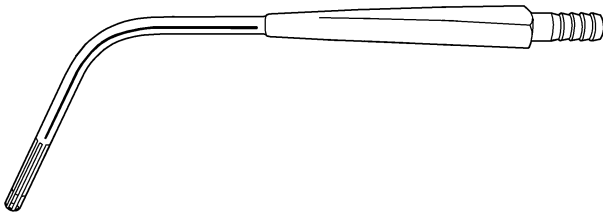

- 42390-30** Cinco Suction Tube, grooved perforated tip, 30 degrees, 4.8mm (3/16") o.d., for 8.0mm (5/16") tubing
- 42390-60** Cinco Suction Tube, grooved perforated tip, 60 degrees, 4.8mm (3/16") o.d., for 8.0mm (5/16") tubing
- 42390-80** Cinco Suction Tube, grooved perforated tip, 80 degrees, 4.8mm (3/16") o.d., for 8.0mm (5/16") tubing



- 42400-15** Bentall Femoral Cannula, rolled edge to bevel, 1.5mm bore
- 42400-20** Bentall Femoral Cannula, rolled edge to bevel, 2.0mm bore
- 42400-25** Bentall Femoral Cannula, rolled edge to bevel, 2.5mm bore
- 42400-30** Bentall Femoral Cannula, rolled edge to bevel, 3.0mm bore
- 42400-35** Bentall Femoral Cannula, rolled edge to bevel, 3.5mm bore
- 42400-40** Bentall Femoral Cannula, rolled edge to bevel, 4.0mm bore
- 42400-45** Bentall Femoral Cannula, rolled edge to bevel, 4.5mm bore
- 42400-50** Bentall Femoral Cannula, rolled edge to bevel, 5.0mm bore
- 42400-55** Bentall Femoral Cannula, rolled edge to bevel, 5.5mm bore
- 42400-60** Bentall Femoral Cannula, rolled edge to bevel, 6.0mm bore
- 42400-65** Bentall Femoral Cannula, rolled edge to bevel, 6.5mm bore.
- 42400-70** Bentall Femoral Cannula, rolled edge to bevel, 7.0mm bore

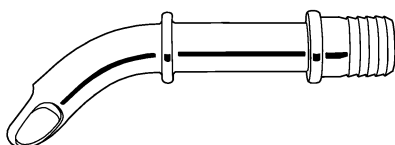

- 42401-50** GOSH Cannula, cage tip, 45 degrees, long, tubing end, 5mm o.d.
- 42401-60** GOSH Cannula, cage tip, 45 degrees, long, tubing end, 6mm o.d.
- 42401-70** GOSH Cannula, cage tip, 45 degrees, long, tubing end, 7mm o.d.
- 42401-80** GOSH Cannula, cage tip, 45 degrees, long, tubing end, 8mm o.d.

- 42402-50** GOSH Cannula, cage tip, 45 degrees, short, tubing end, 5mm o.d.  
**42402-60** GOSH Cannula, cage tip, 45 degrees, short, tubing end, 6mm o.d.

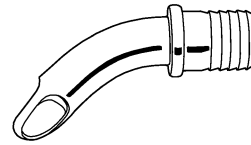

- 42403-20** GOSH Modified Pacifico Cannula, cage tip, 90 degrees, olive end, 2.0mm bore, 2.6mm o.d.  
**42403-25** GOSH Modified Pacifico Cannula, cage tip, 90 degrees, olive end, 2.5mm bore, 3.3mm o.d.  
**42403-33** GOSH Modified Pacifico Cannula, cage tip, 90 degrees, olive end, 3.3mm bore, 4.0mm o.d.  
**42403-40** GOSH Modified Pacifico Cannula, cage tip, 90 degrees, olive end, 4.0mm bore, 4.9mm o.d.  
**42403-50** GOSH Modified Pacifico Cannula, cage tip, 90 degrees, olive end, 5.0mm bore, 5.9mm o.d.  
**42403-55** GOSH Modified Pacifico Cannula, cage tip, 90 degrees, olive end, 5.5mm bore, 6.3mm o.d.  
**42403-63** GOSH Modified Pacifico Cannula, cage tip, 90 degrees, olive end, 6.3mm bore, 7.0mm o.d.  
**42403-80** GOSH Modified Pacifico Cannula, cage tip, 90 degrees, olive end, 8.0mm bore, 9.0mm o.d.

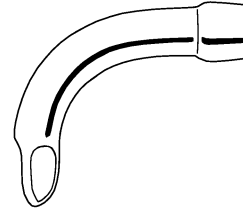

- 42404-10** GOSH Suction Tube, no taper, fluted tip, 40 degrees, for 6.3mm (1/4") tubing  
**42404-20** GOSH Suction Tube, no taper, fluted tip, 70 degrees, for 6.3mm (1/4") tubing

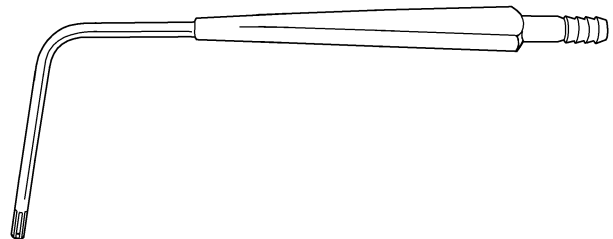

- 42405-75** GOSH Modified Pacifico Cannula, 4 port open ended, 90 degrees, olive end, 7.5mm bore, 8.3mm o.d.  
**42405-83** GOSH Modified Pacifico Cannula, 4 port open ended, 90 degrees, olive end, 8.3mm bore, 9.5mm o.d.

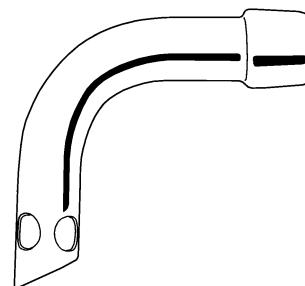

# Thoracic

## Perfusion

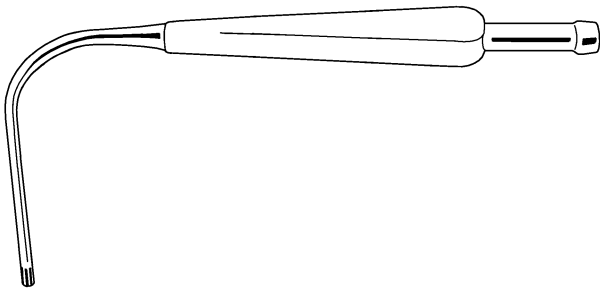

- 42406-10** GOSH Suction Tube, tapered, fluted tip, 40 degrees, for 6.3mm (1/4") tubing
- 42406-20** GOSH Suction Tube, tapered, fluted tip, 40 degrees, for 4.8mm (3/16") tubing
- 42406-30** GOSH Suction Tube, tapered, fluted tip, 40 degrees, for 3.2mm (1/8") tubing
- 42406-40** GOSH Suction Tube, tapered, fluted tip, 90 degrees, for 6.3mm (1/4") tubing
- 42406-50** GOSH Suction Tube, tapered, fluted tip, 90 degrees, for 4.8mm (3/16") tubing

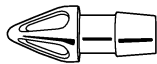

- 42408-32** GOSH Ventricular Vent, cage tip, olive end, 3.2mm (1/8") bore
- 42408-40** GOSH Ventricular Vent, cage tip, olive end, 4.0mm (5/32") bore
- 42408-48** GOSH Ventricular Vent, cage tip, olive end, 4.8mm (3/16") bore

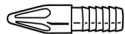

- 42409-20** GOSH Ventricular Vent, cage tip, tubing end, 2.0mm (5/64") bore

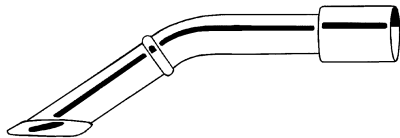

- 42410-25** Iliac Cannula, angled, 2.5mm bore
- 42410-30** Iliac Cannula, angled, 3.0mm bore
- 42410-35** Iliac Cannula, angled, 3.5mm bore
- 42410-40** Iliac Cannula, angled, 4.0mm bore
- 42410-45** Iliac Cannula, angled, 4.5mm bore
- 42410-50** Iliac Cannula, angled, 5.0mm bore
- 42410-55** Iliac Cannula, angled, 5.5mm bore
- 42410-60** Iliac Cannula, angled, 6.0mm bore

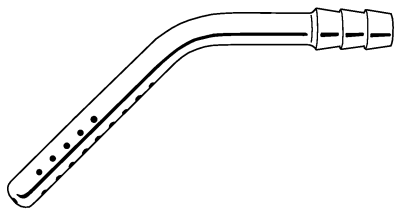

- 42413-40** JS Stark Crooked Vent, 45 degrees, tubing end, 4.0mm o.d.

- 42415-30** JS Venous Cannula, cage tip, 80 degrees, long, tubing end, 3mm bore
- 42415-40** JS Venous Cannula, cage tip, 80 degrees, long, tubing end, 4mm bore
- 42415-50** JS Venous Cannula, cage tip, 80 degrees, long, tubing end, 5mm bore
- 42415-60** JS Venous Cannula, cage tip, 80 degrees, long, tubing end, 6mm bore
- 42415-70** JS Venous Cannula, cage tip, 80 degrees, long, tubing end, 7mm bore
- 42415-80** JS Venous Cannula, cage tip, 80 degrees, long, tubing end, 8mm bore

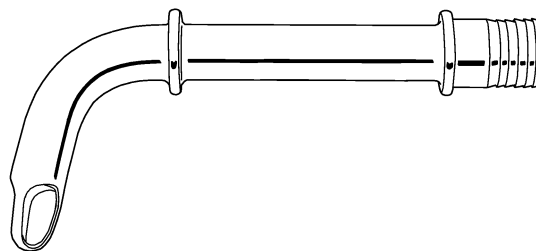

- 42416-30** JS Venous Cannula, cage tip, 80 degrees, short, tubing end, 3mm bore
- 42416-40** JS Venous Cannula, cage tip, 80 degrees, short, tubing end, 4mm bore
- 42416-50** JS Venous Cannula, cage tip, 80 degrees, short, tubing end, 5mm bore
- 42416-60** JS Venous Cannula, cage tip, 80 degrees, short, tubing end, 6mm bore
- 42416-70** JS Venous Cannula, cage tip, 80 degrees, short, tubing end, 7mm bore
- 42416-80** JS Venous Cannula, cage tip, 80 degrees, short, tubing end, 8mm bore

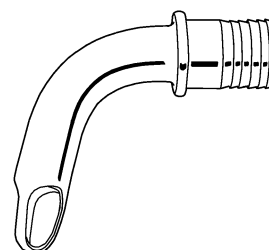

- 42420-12** Ross Atrial Basket, 29mm long, for 12.7mm (1/2") tubing
- 42420-20** Ross Atrial Basket, 29mm long, for 9.5mm (3/8") tubing
- 42420-30** Ross Atrial Basket, 19mm long, for 9.5mm (3/8") tubing
- 42420-40** Ross Atrial Basket, 16mm long, for 6.3mm (1/4") tubing

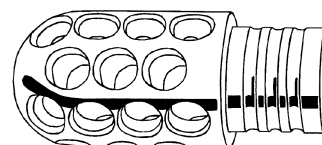

- 42430-10** Ross Sump Sucker, screw apart, adult, 7.5mm o.d., for 3/16" bore tubing
- 42430-20** Ross Sump Sucker, screw apart, child, 6.5mm o.d., for 3/16" bore tubing
- 42430-30** Ross Sump Sucker, screw apart, infant, 5.0mm o.d., for 1/8" bore tubing

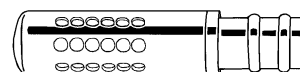

- 43440-10** Ross Ventricular Vent, screw apart, adult, 7.5mm o.d., for 3/16" bore tubing
- 43440-20** Ross Ventricular Vent, screw apart, child, 6.5mm o.d., for 3/16" bore tubing
- 43440-30** Ross Ventricular Vent, screw apart, infant, 5.0mm o.d., for 1/8" bore tubing

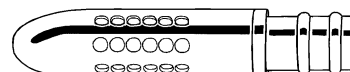

# Thoracic

## Perfusion

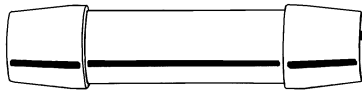

- 43450-06** Straight Connector, 6mm to 6mm, for heart/lung machine
- 43450-09** Straight Connector, 9mm to 9mm, for heart/lung machine
- 43450-12** Straight Connector, 12mm to 12mm, for heart/lung machine

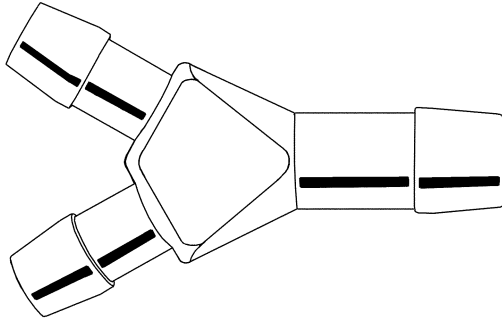

- 43460-12** Y Connector, 12mm to 6mm and 9mm, for heart/lung machine
- 43465-12** Y Connector, 12mm to 6mm and 6mm, for heart/lung machine
- 43470-12** Y Connector, 12mm to 9mm and 9mm, for heart/lung machine

## Probes

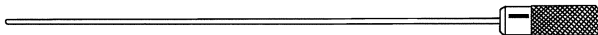

- 43500-05** Ross Coronary Artery Probe, 100mm, 0.5mm
- 43500-10** Ross Coronary Artery Probe, 100mm, 1.0mm
- 43500-15** Ross Coronary Artery Probe, 100mm, 1.5mm
- 43500-20** Ross Coronary Artery Probe, 100mm, 2.0mm
- 43500-25** Ross Coronary Artery Probe, 100mm, 2.5mm
- 43500-30** Ross Coronary Artery Probe, 100mm, 3.0mm
- 43505-05** Ross Coronary Artery Probe, 150mm, 0.5mm
- 43505-10** Ross Coronary Artery Probe, 150mm, 1.0mm
- 43505-15** Ross Coronary Artery Probe, 150mm, 1.5mm
- 43505-20** Ross Coronary Artery Probe, 150mm, 2.0mm
- 43505-25** Ross Coronary Artery Probe, 150mm, 2.5mm
- 43505-30** Ross Coronary Artery Probe, 150mm, 3.0mm

## Punches

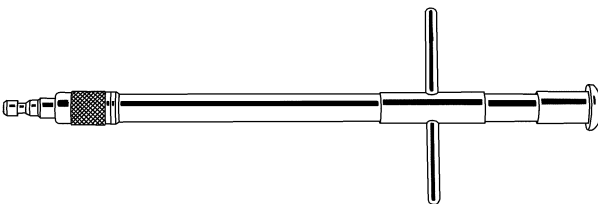

- 43550-40** Goosen Aorta Punch, for making 4.0mm diameter opening in Aorta for vein grafts
- 43550-45** Goosen Aorta Punch, for making 4.5mm diameter opening in Aorta for vein grafts
- 43550-48** Goosen Aorta Punch, for making 4.8mm diameter opening in Aorta for vein grafts
- 43550-55** Goosen Aorta Punch, for making 5.5mm diameter opening in Aorta for vein grafts
- 43550-65** Goosen Aorta Punch, for making 6.5mm diameter opening in Aorta for vein grafts



**43580-24** Morrision Davies Rib Raspatory, slight curve, 240mm

**43590-24** Morrision Davies Rib Raspatory, full curve, 240mm

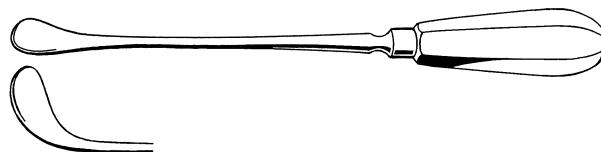

**43595-15** Nelson Rib Raspatory, 150mm

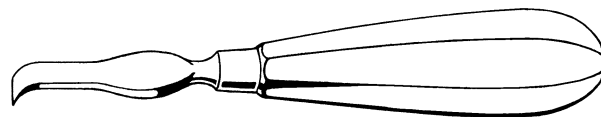

**43600-12** Price Thomas Rib Raspatory, 12mm wide

**43600-20** Price Thomas Rib Raspatory, 20mm wide

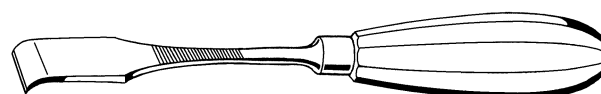

**43605-25** Ronald Edwards Rib Raspatory, long slender blade, 250mm

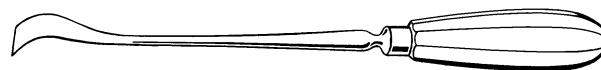

**43610-20** Semb Raspatory, No.8, chisel end, for disarticulation of costo-vertebral joint, 200mm



**43620-25** Semb Raspatory, No.7, long shaft, for edge of first rib, 250mm



**43630-23** Semb Raspatory, No.2, long shaft, notched end for rib edge, 235mm

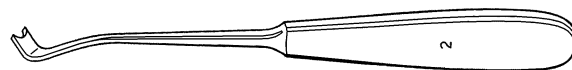

**43650-20** Semb Raspatory, No.1, short shaft, notched end for rib edge, 200mm

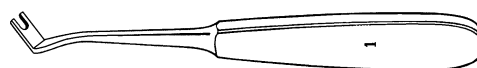

**43660-22** Semb Raspatory, No.5, short shaft, oval end, 220mm

**43670-19** Semb Raspatory, No.6, short shaft, oval end angled for back of first rib, 195mm

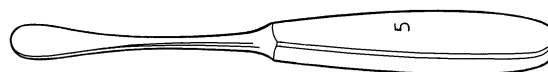

# Thoracic

## Raspatories



**43640-25** Semb Raspatory, No.4, long shaft, straight end, 250mm

**43680-19** Semb Raspatory, No.3, short shaft, straight end, 190mm

## Retractors

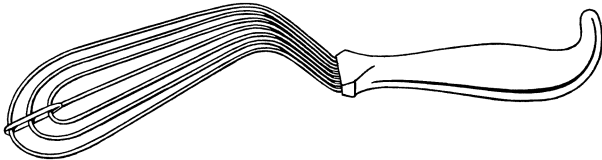

**43700-10** Allison Lung Retractor, s/s, adult, 300mm

**43700-20** Allison Lung Retractor, s/s, child, 280mm

**43700-30** Allison Lung Retractor, s/s, infant, 280mm

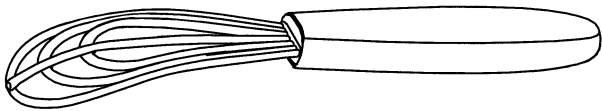

**43700-40** Allison Lung Retractor, s/s, neonate, 140mm

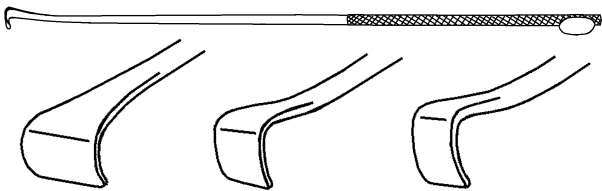

**43710-05** Blanco Valve Leaflet Retractor, 280mm, 5mm

**43710-07** Blanco Valve Leaflet Retractor, 280mm, 7mm

**43710-10** Blanco Valve Leaflet Retractor, 280mm, 10mm

**43710-90** Blanco Valve Leaflet Retractor, 280mm, set of 3

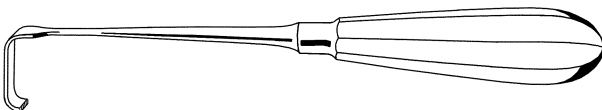

**43720-10** Brock Erector Spinae Retractor, hollow handle

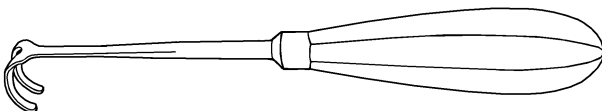

**43725-10** Brompton Erector Spinae Retractor, open blades

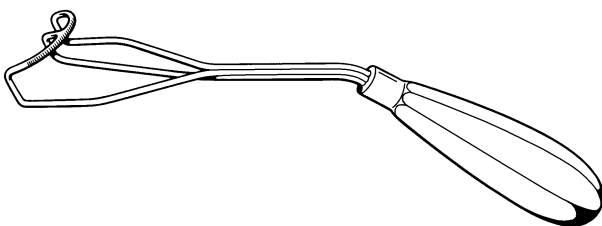

**43732-10** Cooley Atrial Retractor, left side, 240mm, 45mm wide blade

**43732-20** Cooley Atrial Retractor, right side, 240mm, 45mm wide blade

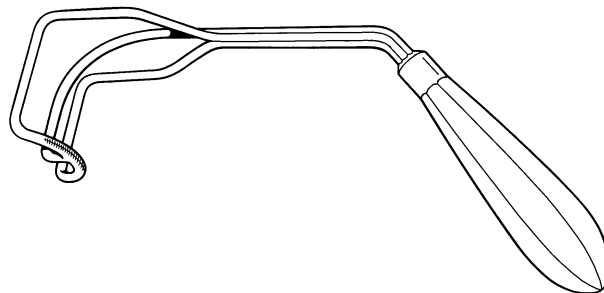

**43735-10** Hedley Brown Retractor

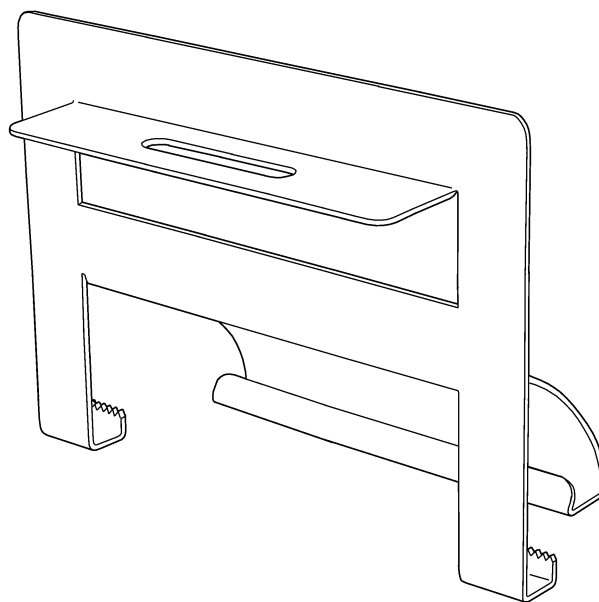

**43740-10** Ross Aortic Retractor, No.1  
**43740-20** Ross Aortic Retractor, No.2  
**43740-30** Ross Aortic Retractor, No.3  
**43740-40** Ross Aortic Retractor, No.4  
**43740-50** Ross Aortic Retractor, No.5  
**43740-60** Ross Aortic Retractor, No.6  
**43740-90** Ross Aortic Retractor, set of 6

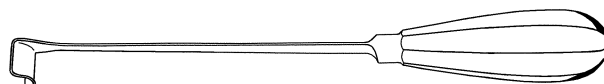

**43750-10** Semb Erector Spinae Retractor, large  
**43750-20** Semb Erector Spinae Retractor, small

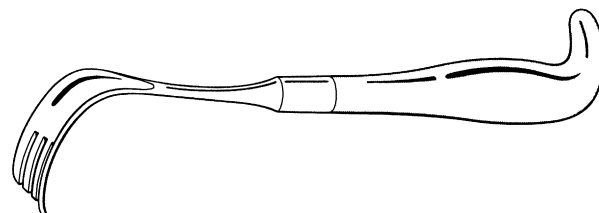

# Thoracic

## Retractors

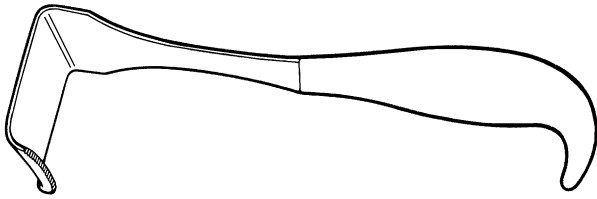

**43760-20** Tudor Edwards Scapula Retractor, 200mm, 50mm x 45mm blade

## Rib Shears

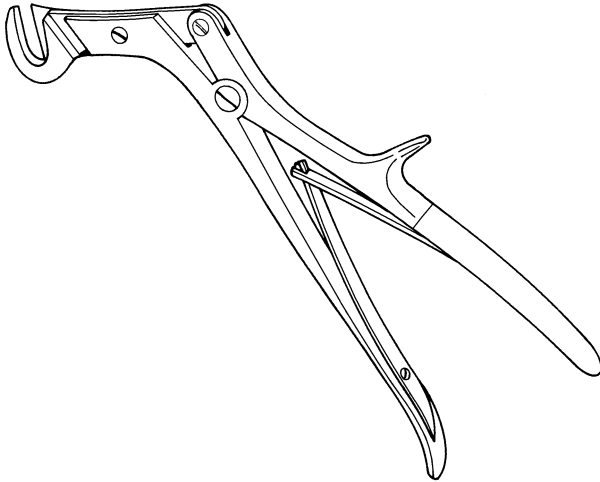

**43800-27** Giertz Rib Shear, 270mm

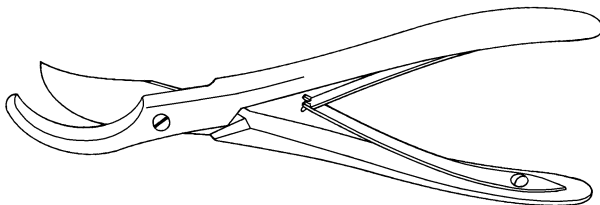

**43830-22** Spring Rib Shear, curved, 220mm

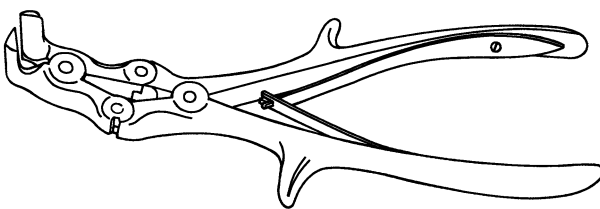

**43850-23** Tudor Edwards Rib Shear, compound action, anterior, 235mm

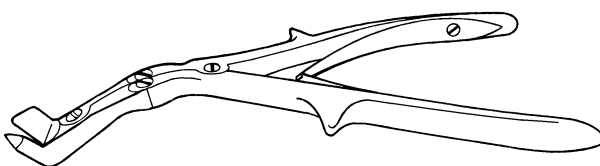

**43860-25** Tudor Edwards Rib Shear, compound action, posterior, 250mm

**43900-16** Bailey Rib Spreader, 160mm

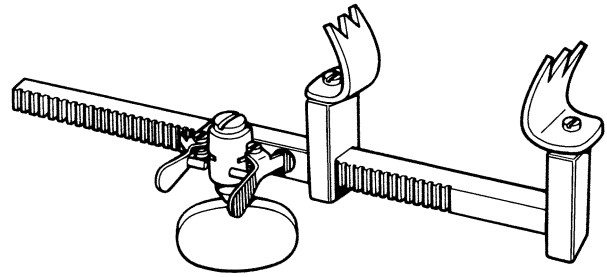

**43910-25** Burford Rib Spreader, with 2 pairs of blades, 250mm, 80 x 67mm and 40 x 67mm

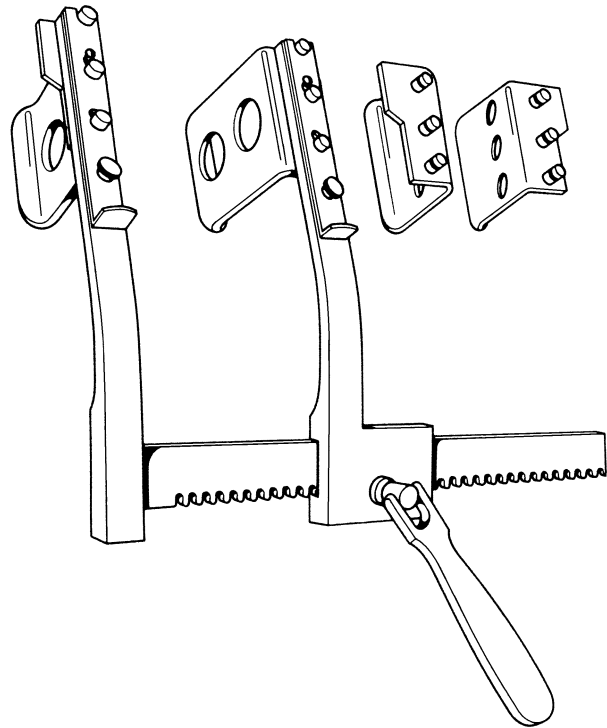

**43917-20** Collins Rib Spreader, frame only

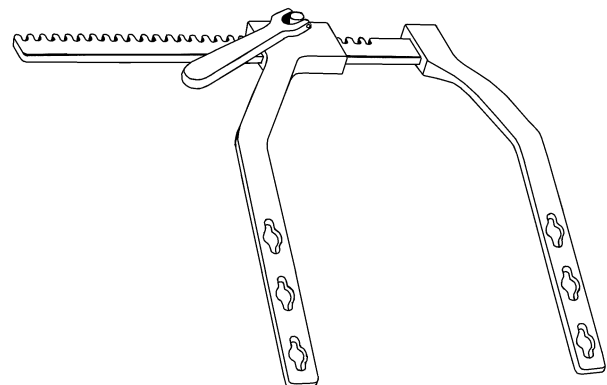

# Thoracic

## Rib Spreaders

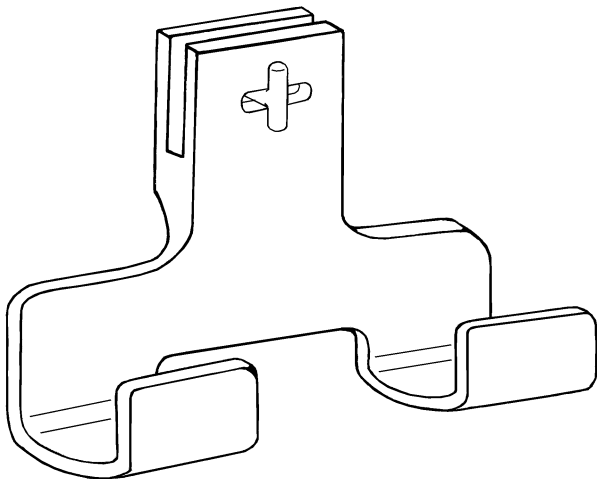

- 43917-50** Collins Rib Spreader, blades only, 120mm wide x 38mm deep, with locking pegs, pair

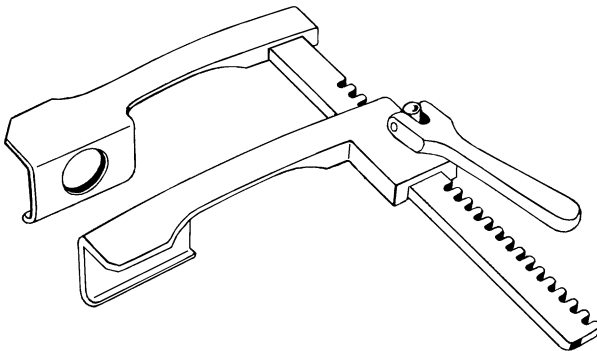

- 43920-18** Finochietto Rib Spreader, 18mm deep x 21mm wide blades  
**43920-36** Finochietto Rib Spreader, 36mm deep x 45mm wide blades  
**43920-44** Finochietto Rib Spreader, 44mm deep x 65mm wide blades  
**43920-50** Finochietto Rib Spreader, 50mm deep x 60mm wide blades  
**43920-65** Finochietto Rib Spreader, 65mm deep x 65mm wide blades  
**43922-18** Finochietto Rib Spreader, aluminium, 18mm deep x 18mm wide blades  
**43922-50** Finochietto Rib Spreader, aluminium, 50mm deep x 60mm wide blades  
**43922-65** Finochietto Rib Spreader, aluminium, 65mm deep x 65mm wide blades

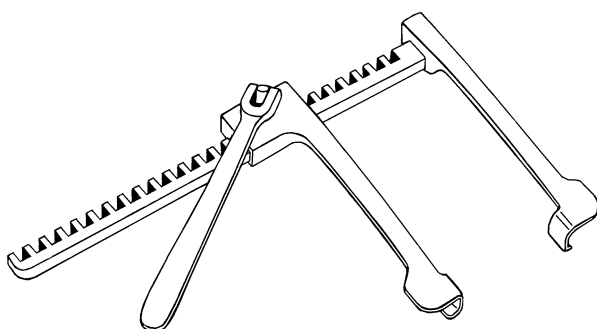

- 43970-09** Duncan Walker Rib Spreader, neonatal, 9mm deep x 5mm wide blades  
**43970-12** Duncan Walker Rib Spreader, neonatal, 12mm deep x 7mm wide blades

- 44000-10** IMA Rib Spreader, channeled blade only
- 44000-20** IMA Rib Spreader, long claw blade only
- 44000-30** IMA Rib Spreader, short claw blade only
- 44000-90** IMA Rib Spreader, complete, for internal mammary artery procedures, converts left or right

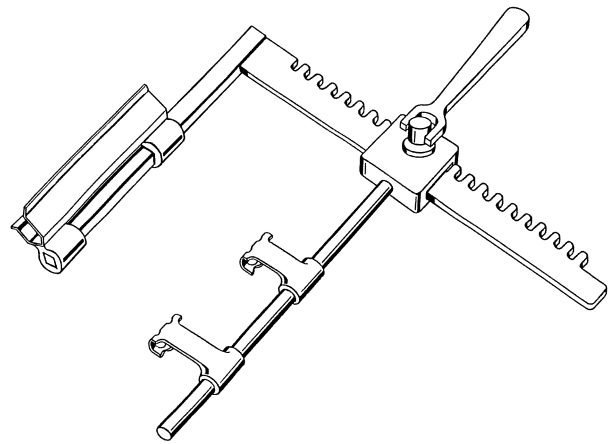

- 
- 44005-27** Morse-Favaloro Rib Spreader, curved arms  
215mm long, swivel blades, 275mm

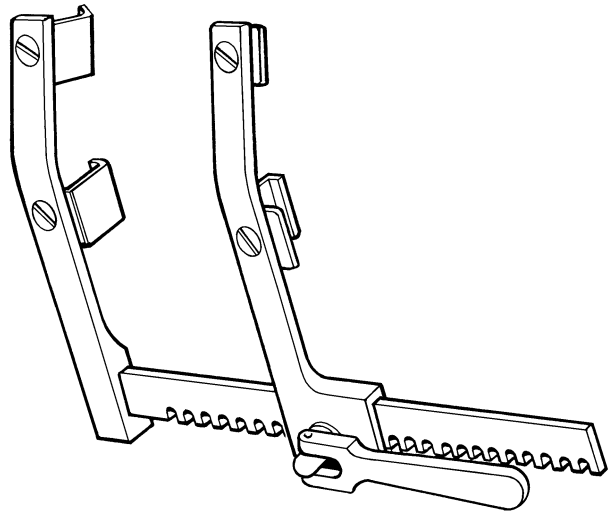

- 
- 44006-27** Morse-Favaloro Rib Spreader, curved arms  
185mm long, swivel blades, 275mm

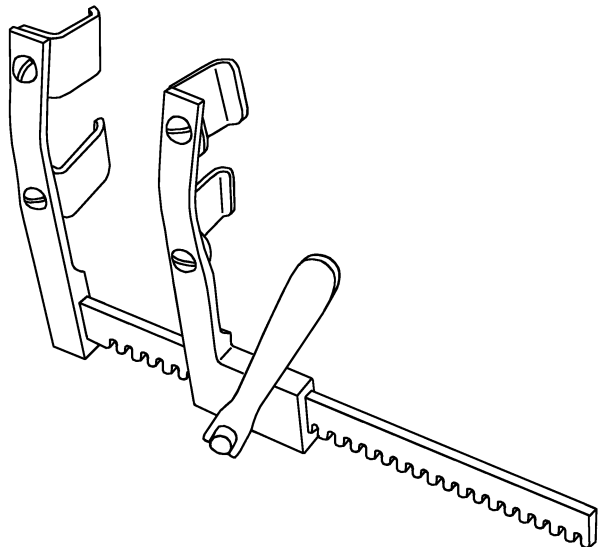

# Thoracic

## Rib Spreaders

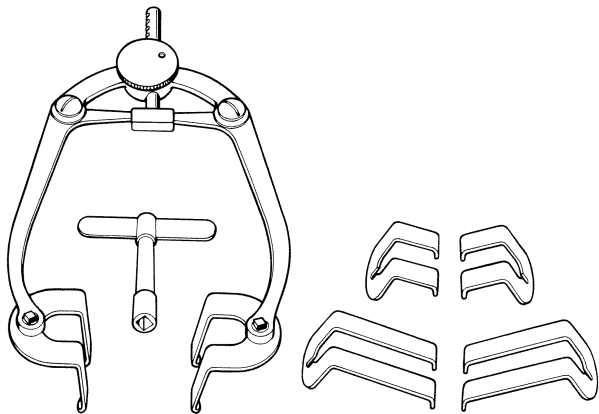

- 44010-10** Price Thomas Rib Spreader, blade only, 50mm x 38mm, pair
- 44010-20** Price Thomas Rib Spreader, blade only, 50mm x 45mm, pair
- 44010-30** Price Thomas Rib Spreader, blade only, 50mm x 65mm, pair
- 44010-35** Price Thomas Rib Spreader, nut and bolt for blade only
- 44010-40** Price Thomas Rib Spreader, frame only
- 44010-50** Price Thomas Rib Spreader, key only
- 44010-90** Price Thomas Rib Spreader, complete with 3 pairs of blades, key, 250mm, 215mm, 68mm

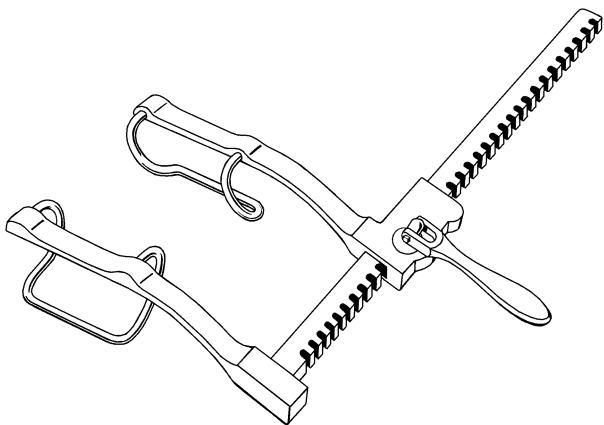

- 44020-10** Ronald Edwards Rib Spreader, curved arms, fenestrated, infant, 100mm, 25 x 30mm blades
- 44020-15** Ronald Edwards Rib Spreader, curved arms, fenestrated, child, 150mm, 30 x 50mm blades
- 44020-24** Ronald Edwards Rib Spreader, curved arms, fenestrated, adult, 245mm, 65 x 75mm blades

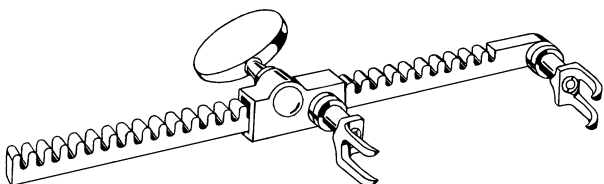

- 44030-20** Sellors Rib Spreader And Approximator Combined, 200mm



Rib Spreaders

- 44035-10 Sellors Rib Spreader, blade only, 50mm x 38mm, pair
- 44035-20 Sellors Rib Spreader, blade only, 50mm x 45mm, pair
- 44035-30 Sellors Rib Spreader, blade only, 50mm x 65mm, pair
- 44035-35 Sellors Rib Spreader, frame only
- 44035-40 Sellors Rib Spreader, nut and bolt for blade only
- 44035-50 Sellors Rib Spreader, key only
- 44035-90 Sellors Rib Spreader, curved arms, complete, 3 pairs of blades, key

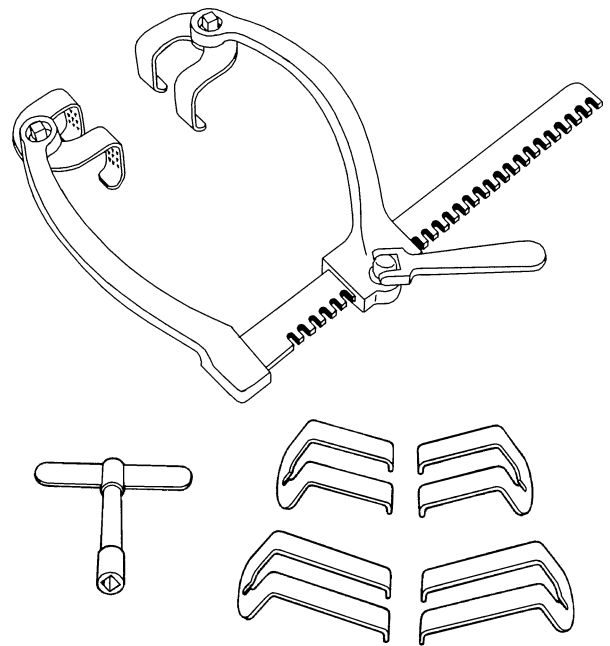

- 44035-60 Sellors Rib Spreader, harefield sternal blade only, 70mm x 30mm, pair

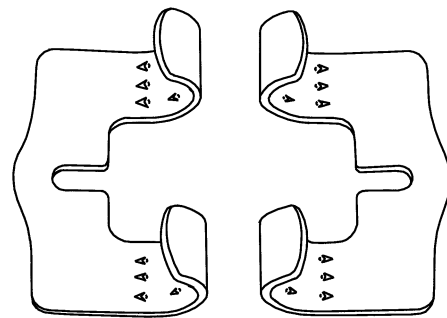

- 44035-70 Sellors Rib Spreader, harefield sternal blade only, 120mm x 30mm, pair

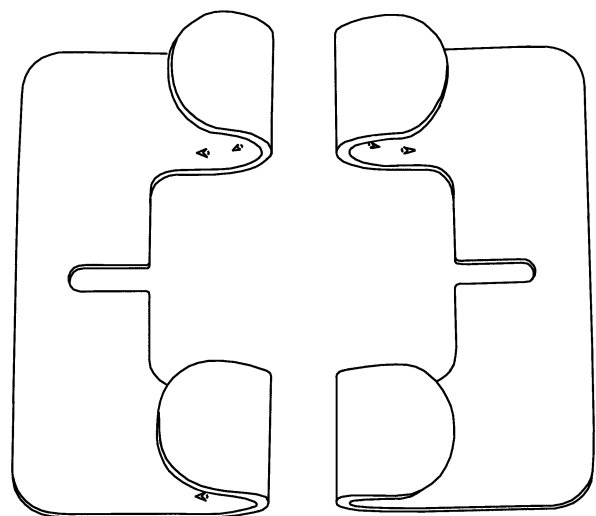

# Thoracic

## Rib Spreaders

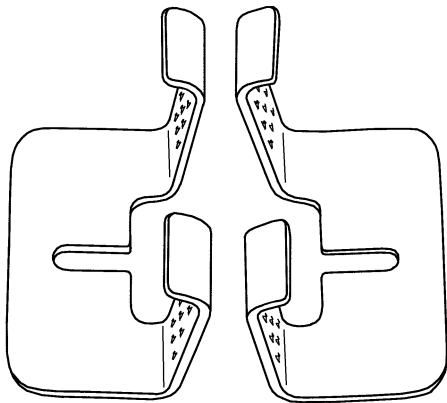

**44035-80** Sellors Rib Spreader, harefield scapula blade only, 75mm x 70mm, pair

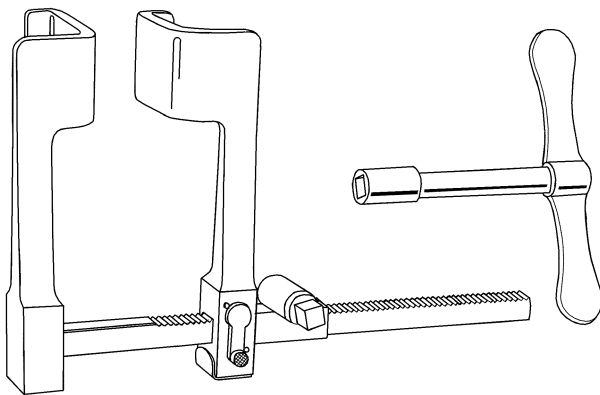

**44040-25** Tudor Edwards Modified Tuffier Rib Spreader, 25mm wide x 35mm deep blades, c/w key

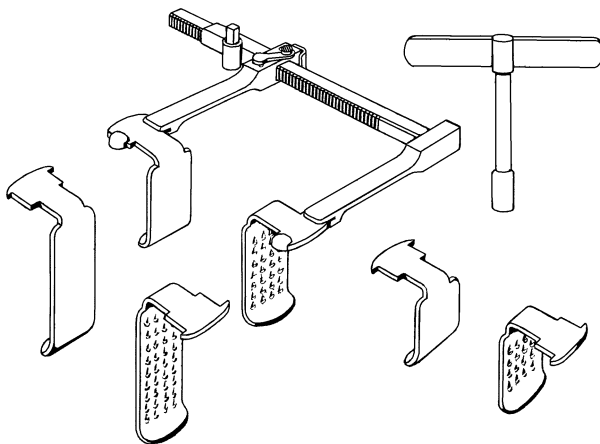

- 44050-10** Tudor Edwards Rib Spreader, blade only, 25mm, pair
- 44050-20** Tudor Edwards Rib Spreader, blade only, 50mm, pair
- 44050-30** Tudor Edwards Rib Spreader, blade only, 75mm, pair
- 44050-90** Tudor Edwards Rib Spreader, complete, 2 x 25mm, 2 x 50mm, 2 x 75mm blades, key

**44055-90** Tudor Edwards Double Rib Spreader, complete, 4 x 25mm, 4 x 50mm, 4 x 75mm blades, 2 x keys

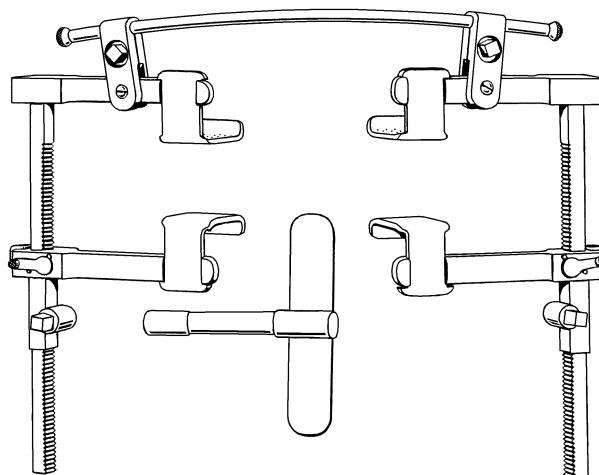

**44060-16** Tuffier Rib Spreader, 165mm, 50mm x 45mm blades

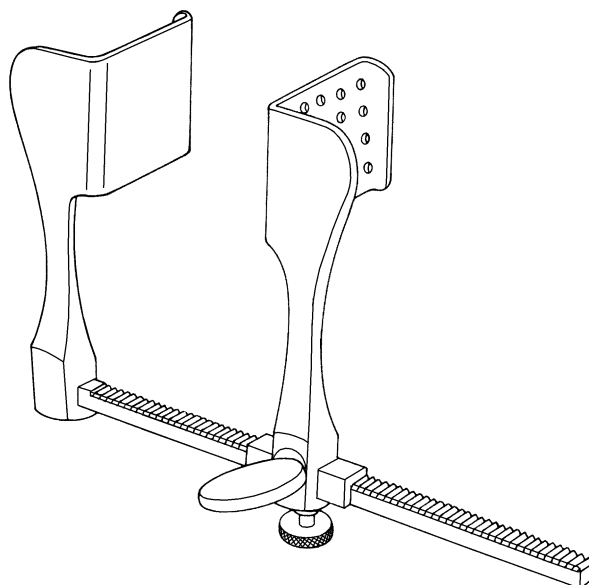

# Thoracic

## Rib Spreaders

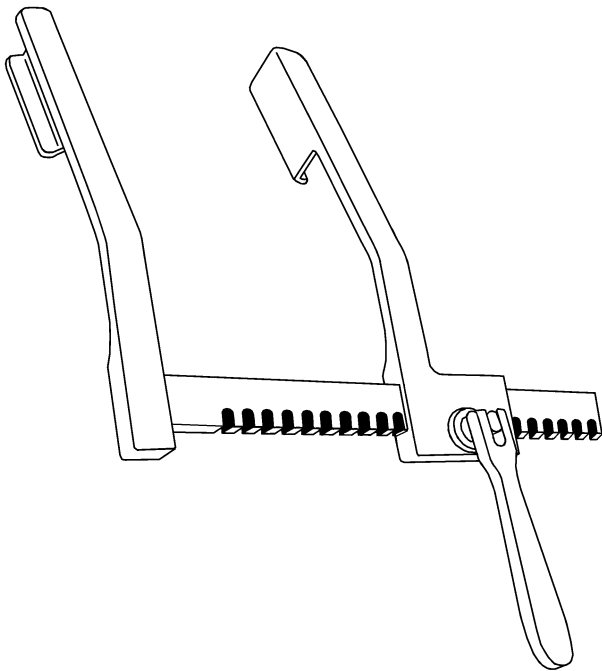

**44070-20** Papworth Rib Spreader, 25mm x 65mm blades, 205mm spread

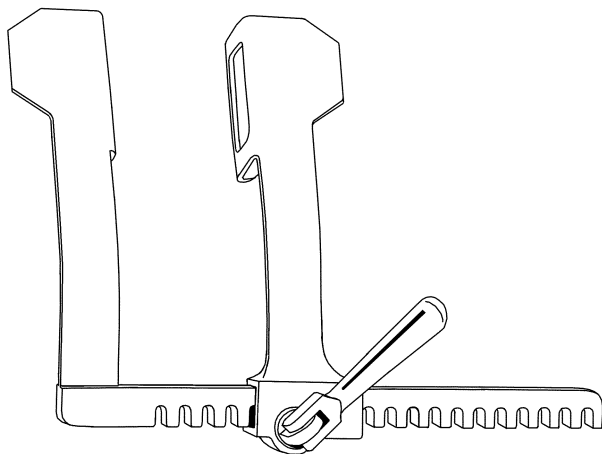

**44090-90** Waterston Rib Spreader, infant

## Scissors

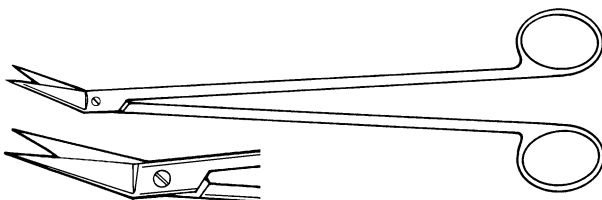

**44150-19** Potts-Smith Scissor, angled blades 25 degree, 190mm

## Scissors

**44160-19** Potts-Smith Scissor, angled blades 45 degree, 190mm

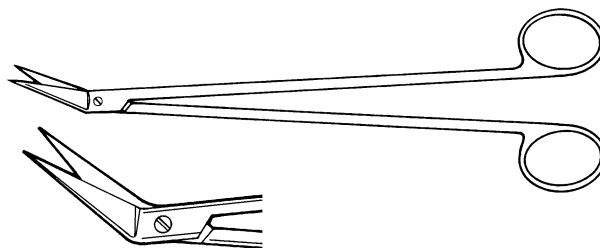

**44170-19** Potts-Smith Scissor, angled blades 60 degree, 190mm

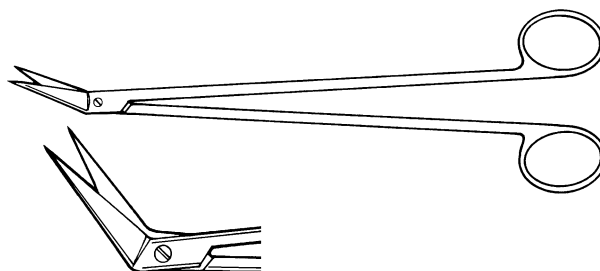

**44180-19** Potts-Smith Scissor, angled blades 125 degree, 190mm

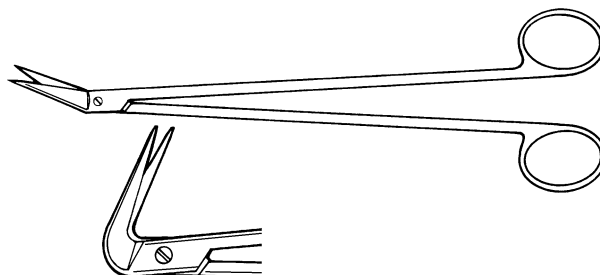

## Scissors - Tungsten Carbide

**44330-19** Potts-Smith Scissor, tungsten carbide, angled blades 25 degree, 190mm

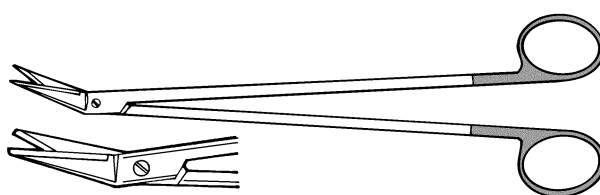

**44340-19** Potts-Smith Scissor, tungsten carbide, angled blades 45 degree, 190mm

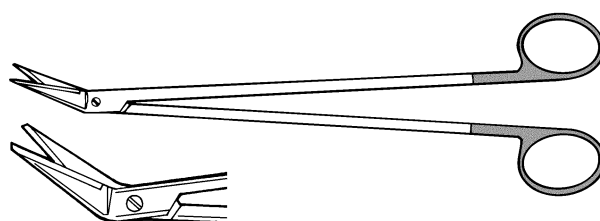

## Thoracic

### Scissors - Tungsten Carbide

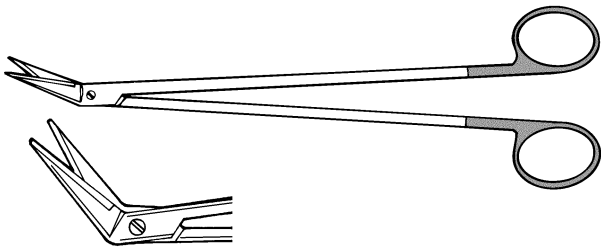

- 44350-19** Potts-Smith Scissor, tungsten carbide, angled blades 60 degree, 190mm

### Sounds

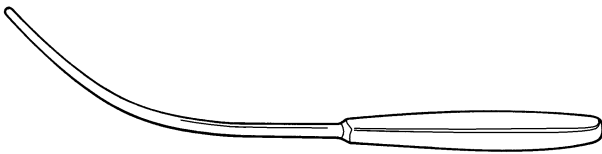

- 44380-05** Brock Cardiac Sound, 260mm, 5.0mm  
**44380-07** Brock Cardiac Sound, 260mm, 7.5mm  
**44380-10** Brock Cardiac Sound, 260mm, 10.0mm  
**44380-12** Brock Cardiac Sound, 260mm, 12.0mm  
**44380-90** Brock Cardiac Sound, set of 4

### Sternal Lifting Retractors

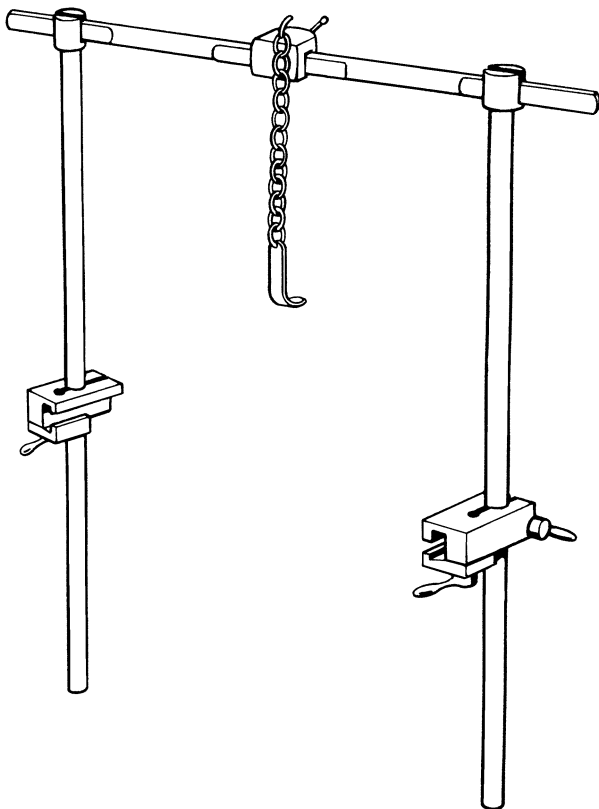

- 44400-16** Goligher Sternal Lifting Retractor, 16mm wide blade and chain only  
**44400-38** Goligher Sternal Lifting Retractor, 38mm wide blade and chain only  
**44400-60** Goligher Sternal Lifting Retractor, frame only  
**44400-70** Goligher Sternal Lifting Retractor, table clamp only  
**44400-80** Goligher Sternal Lifting Retractor, top clamp only  
**44400-90** Goligher Sternal Lifting Retractor, complete with clamps and 2 x 16mm blade and chain

## Sternal Lifting Retractors

- 44410-09** Rochard Sternal Lifting Retractor, blade 'A' only, 50mm x 90mm
- 44410-10** Rochard Sternal Lifting Retractor, blade 'B' only, 50mm x 105mm
- 44410-12** Rochard Sternal Lifting Retractor, blade 'C' only, 50mm x 120mm
- 44410-13** Rochard Sternal Lifting Retractor, blade 'D' only, 50mm x 135mm
- 44410-15** Rochard Sternal Lifting Retractor, blade 'E' only, 50mm x 155mm
- 44410-50** Rochard Sternal Lifting Retractor, fixation device only
- 44410-60** Rochard Sternal Lifting Retractor, frame only
- 44410-80** Rochard Sternal Lifting Retractor, top clamp only
- 44410-90** Rochard Sternal Lifting Retractor, complete, 5 x blades, 1 x fixation device, 1 x frame, 2 x top clamps, 2 x table clamps

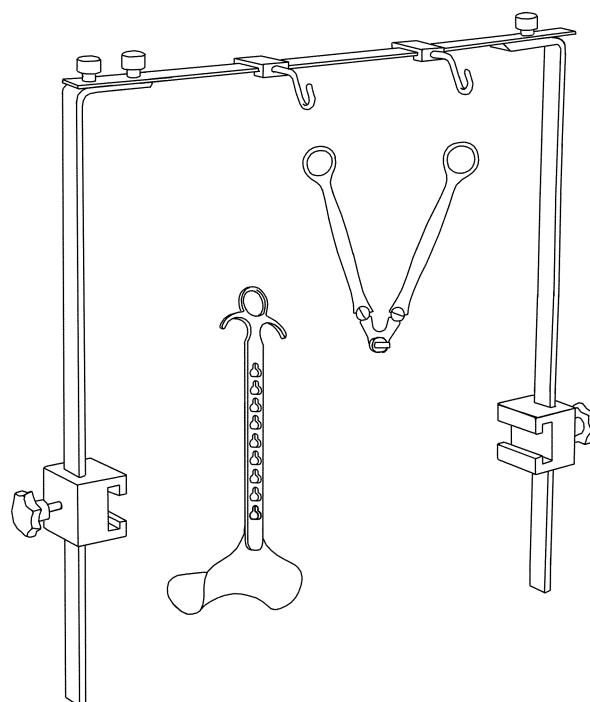

## Suction Tubes

- 44470-10** Brompton Hospital Suction Tube, adult, for 9.5mm (3/8") tubing
- 44470-20** Brompton Hospital Suction Tube, child, for 6.5mm (1/4") tubing

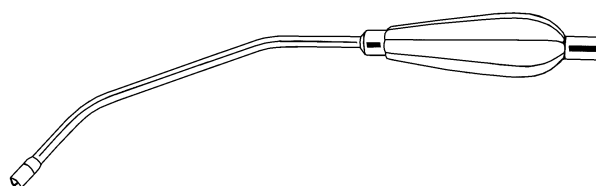

- 44470-30** Brompton Hospital Suction Tube, paediatric, 4.8mm (3/16") o.d., for 6.5mm (1/4") tubing

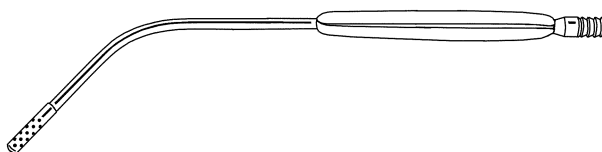

- 44485-10** Sarns Suction Tube, large, tube only, 285mm
- 44485-50** Sarns Suction Tube, large, tip only, 7.0mm dia. x 55mm long
- 44485-60** Sarns Suction Tube, large, tip only, 9.0mm dia. x 55mm long
- 44485-90** Sarns Suction Tube, large, complete with 7.0mm and 9.0mm tips

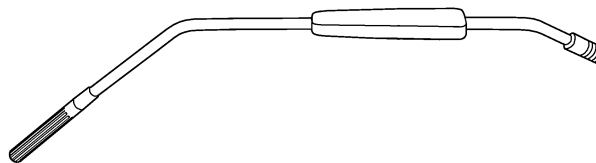

# Thoracic

## Suction Tubes

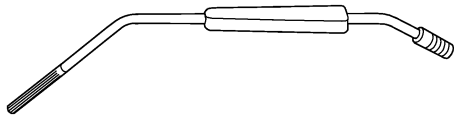

- 44487-10** Sarns Suction Tube, small, tube only, 210mm
- 44487-50** Sarns Suction Tube, small, tip only, 4.5mm dia. x 45mm long
- 44487-90** Sarns Suction Tube, small, complete with 4.5mm dia. tip

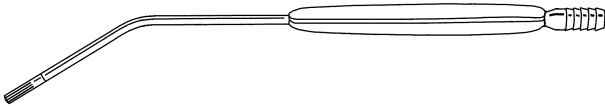

- 44490-10** Southampton Western Hospital Suction Tube, paediatric, 3.3mm (1/8") o.d., for 6.5mm (1/4") tubing

## Tissue Forceps - Atraumatic



- 44500-15** DeBakey Atraumatic Tissue Forcep, 1/2 serrations, 1.5mm jaw, 150mm
- 44500-18** DeBakey Atraumatic Tissue Forcep, 1/2 serrations, 1.5mm jaw, 180mm
- 44500-19** DeBakey Atraumatic Tissue Forcep, 1/2 serrations, 1.5mm jaw, 195mm
- 44500-24** DeBakey Atraumatic Tissue Forcep, 1/2 serrations, 1.5mm jaw, 240mm



- 44510-15** DeBakey Atraumatic Tissue Forcep, 1/2 serrations, 2mm jaw, 150mm
- 44510-18** DeBakey Atraumatic Tissue Forcep, 1/2 serrations, 2mm jaw, 180mm
- 44510-19** DeBakey Atraumatic Tissue Forcep, 1/2 serrations, 2mm jaw, 195mm
- 44510-24** DeBakey Atraumatic Tissue Forcep, 1/2 serrations, 2mm jaw, 240mm

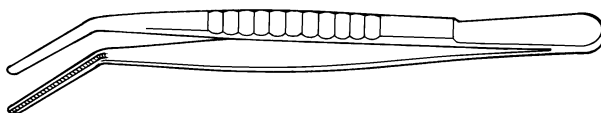

- 44520-15** DeBakey Atraumatic Tissue Forcep, 1/2 serrations, angled, 2mm jaw, 150mm
- 44520-18** DeBakey Atraumatic Tissue Forcep, 1/2 serrations, angled, 2mm jaw, 180mm
- 44520-19** DeBakey Atraumatic Tissue Forcep, 1/2 serrations, angled, 2mm jaw, 195mm
- 44520-24** DeBakey Atraumatic Tissue Forcep, 1/2 serrations, angled, 2mm jaw, 240mm

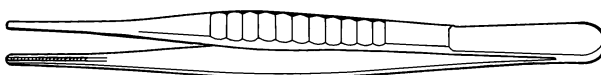

- 44530-15** DeBakey Atraumatic Tissue Forcep, 1/2 serrations, 2.4mm jaw, 150mm
- 44530-18** DeBakey Atraumatic Tissue Forcep, 1/2 serrations, 2.4mm jaw, 180mm
- 44530-19** DeBakey Atraumatic Tissue Forcep, 1/2 serrations, 2.4mm jaw, 195mm
- 44530-24** DeBakey Atraumatic Tissue Forcep, 1/2 serrations, 2.4mm jaw, 240mm



## Tissue Forceps - Atraumatic

- 44540-15** DeBakey Atraumatic Tissue Forcep, 1/2 serrations, 2.7mm jaw, 150mm
- 44540-18** DeBakey Atraumatic Tissue Forcep, 1/2 serrations, 2.7mm jaw, 180mm
- 44540-19** DeBakey Atraumatic Tissue Forcep, 1/2 serrations, 2.7mm jaw, 195mm
- 44540-24** DeBakey Atraumatic Tissue Forcep, 1/2 serrations, 2.7mm jaw, 240mm

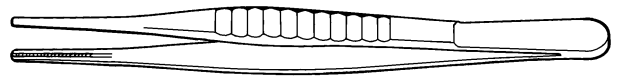

## Trocars

- 44600-22** Nelson Empyema Trocar, complete with cannula, 190mm, 22FG
- 44600-27** Nelson Empyema Trocar, complete with cannula, 190mm, 27FG
- 44600-33** Nelson Empyema Trocar, complete with cannula, 190mm, 33FG

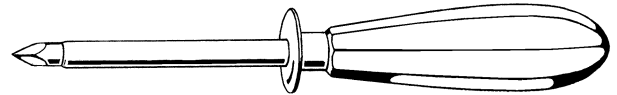

# Orthopaedic

## Bone Awls

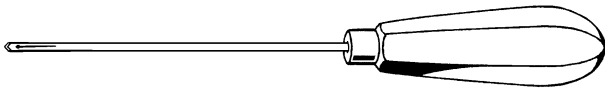

- 50900-20** Plain Bone Awl, straight with eye, 2.0mm diameter, 170mm
- 50900-25** Plain Bone Awl, straight with eye, 2.5mm diameter, 170mm
- 50900-30** Plain Bone Awl, straight with eye, 3.0mm diameter, 170mm
- 50900-40** Plain Bone Awl, straight with eye, 4.0mm diameter, 170mm



- 50950-18** Charnley Bone Awl, 180mm

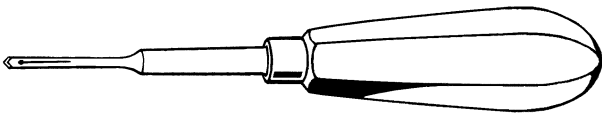

- 51000-20** Shouldered Bone Awl, straight with eye, 2.0mm diameter, 125mm
- 51000-24** Shouldered Bone Awl, straight with eye, 2.4mm diameter, 130mm
- 51000-28** Shouldered Bone Awl, straight with eye, 2.8mm diameter, 145mm
- 51000-32** Shouldered Bone Awl, straight with eye, 3.2mm diameter, 160mm
- 51000-36** Shouldered Bone Awl, straight with eye, 3.6mm diameter, 165mm
- 51000-40** Shouldered Bone Awl, straight with eye, 4.0mm diameter, 175mm

## Bone Curettes

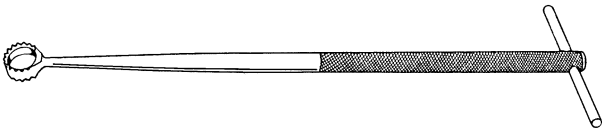

- 51110-37** Charnley Ring Curette, with T handle, double sided, serrated cutting edges, 370mm

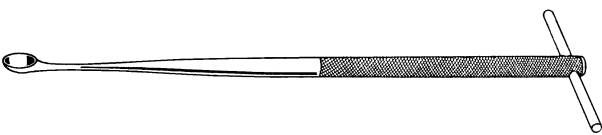

- 51120-10** Charnley Bone Curette, with T handle, large, 22mm x 16mm, 370mm
- 51120-20** Charnley Bone Curette, with T handle, medium, 17mm x 13mm, 370mm
- 51120-30** Charnley Bone Curette, with T handle, small, 14mm x 11mm, 370mm

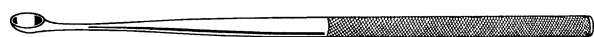

- 51122-10** Charnley Bone Curette, without T handle, large, 22mm x 16mm, 370mm
- 51122-20** Charnley Bone Curette, without T handle, medium, 17mm x 13mm, 370mm
- 51122-30** Charnley Bone Curette, without T handle, small, 14mm x 11mm, 370mm

- 51124-22** Harris Bone Curette, tufnol handle, 275mm, 6mm x 22mm  
**51124-24** Harris Bone Curette, tufnol handle, 275mm, 8mm x 24mm

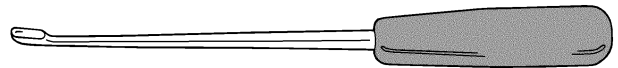

- 51125-29** Miller Acetabular Bone Curette, tufnol handle, cranked shaft, triangular bowl, 26mm x 29mm, 290mm

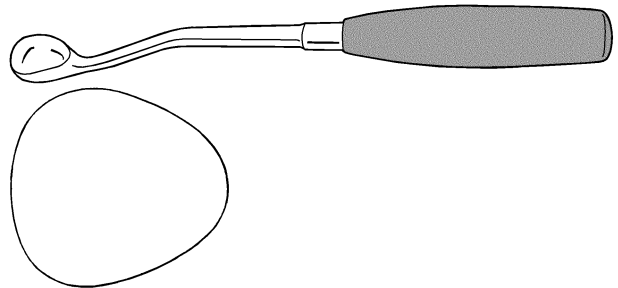

- 51126-10** Tufnol Handled Bone Curette, large, 290mm  
**51126-20** Tufnol Handled Bone Curette, medium, 290mm  
**51126-30** Tufnol Handled Bone Curette, small, 290mm

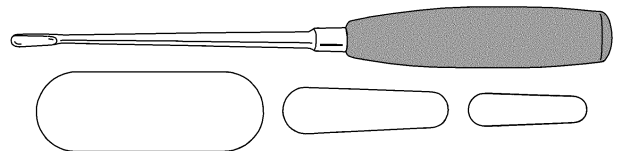

- 51130-10** Volkmann Bone Curette, double ended, 220mm, large  
**51130-20** Volkmann Bone Curette, double ended, 220mm, medium  
**51130-30** Volkmann Bone Curette, double ended, 220mm, small

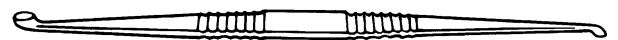

- 51140-10** Volkmann Bone Curette, single ended, 180mm, No.1  
**51140-20** Volkmann Bone Curette, single ended, 180mm, No.2  
**51140-30** Volkmann Bone Curette, single ended, 180mm, No.3  
**51140-40** Volkmann Bone Curette, single ended, 180mm, No.4  
**51140-50** Volkmann Bone Curette, single ended, 180mm, No.5  
**51140-60** Volkmann Bone Curette, single ended, 180mm, No.6



# Orthopaedic

## Bone Cutting Forceps

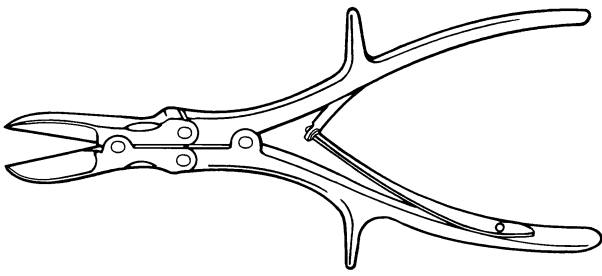

- 51200-25** Horsley Bone Cutting Forcep, compound action, curved, 255mm
- 51210-25** Horsley Bone Cutting Forcep, compound action, straight, 255mm

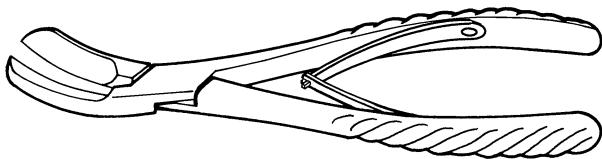

- 51220-15** Liston Bone Cutting Forcep, curved, 150mm
- 51220-18** Liston Bone Cutting Forcep, curved, 180mm
- 51220-20** Liston Bone Cutting Forcep, curved, 200mm
- 51220-23** Liston Bone Cutting Forcep, curved, 230mm

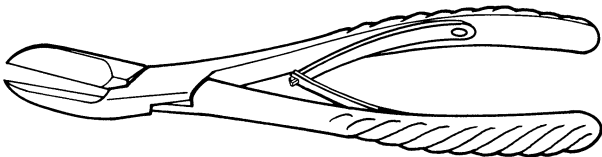

- 51225-15** Liston Bone Cutting Forcep, angled, 150mm
- 51225-18** Liston Bone Cutting Forcep, angled, 180mm
- 51225-20** Liston Bone Cutting Forcep, angled, 200mm
- 51225-23** Liston Bone Cutting Forcep, angled, 230mm

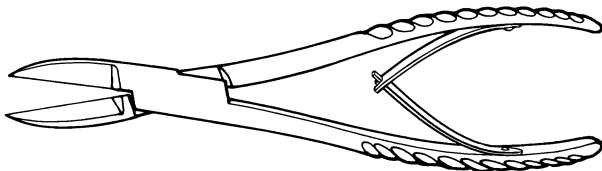

- 51230-15** Liston Bone Cutting Forcep, straight, 150mm
- 51230-18** Liston Bone Cutting Forcep, straight, 180mm
- 51230-20** Liston Bone Cutting Forcep, straight, 200mm
- 51230-23** Liston Bone Cutting Forcep, straight, 230mm

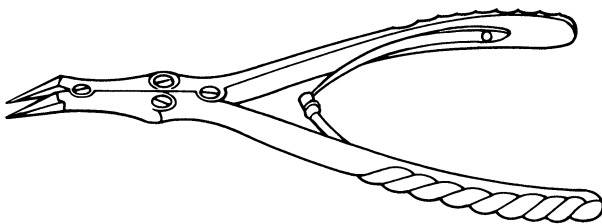

- 51240-17** McIndoe Bone Cutting Forcep, compound action, 170mm

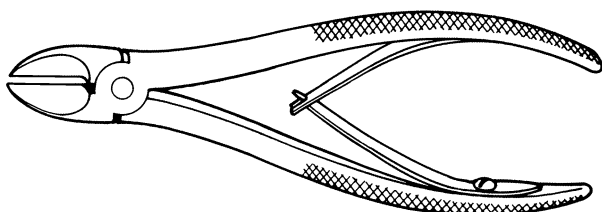

- 51250-14** Paton Bone Cutting Forcep, 140mm

## Bone Cutting Forceps

**51260-14** Stamm Bone Cutting Forcep, 150mm

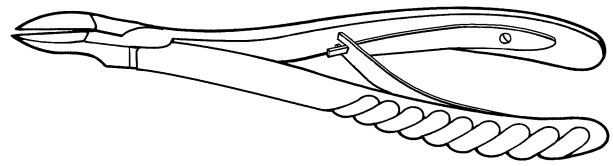

## Bone Holding Clamps

**51300-12** Lowman Bone Holding Clamp, 120mm

**51300-17** Lowman Bone Holding Clamp, 170mm

**51300-20** Lowman Bone Holding Clamp, 200mm

**51300-22** Lowman Bone Holding Clamp, 220mm

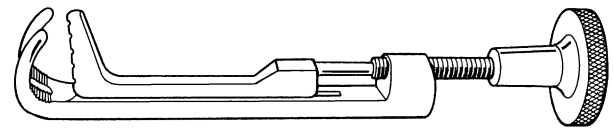

## Bone Holding Forceps

**51400-19** Burns Bone Holding Forcep, 190mm

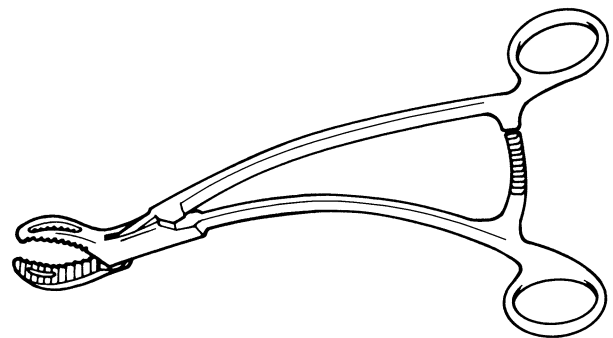

**51410-15** Fergusson Bone Holding Forcep, screw joint, 150mm

**51410-20** Fergusson Bone Holding Forcep, screw joint, 200mm

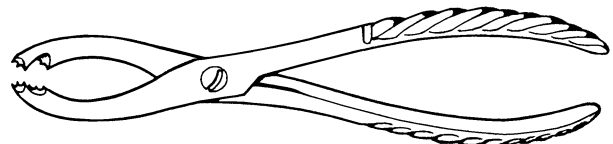

**51420-20** Hey Groves Bone Holding Forcep, 200mm

**51420-25** Hey Groves Bone Holding Forcep, 255mm

**51420-30** Hey Groves Bone Holding Forcep, 305mm

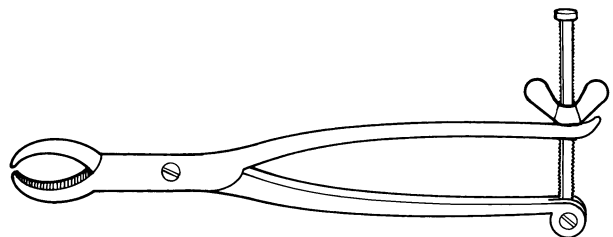

**51440-19** Necrosis (Sequestrum) Bone Holding Forcep, angled, screw joint, 190mm

**51440-20** Necrosis (Sequestrum) Bone Holding Forcep, angled, screw joint, 200mm

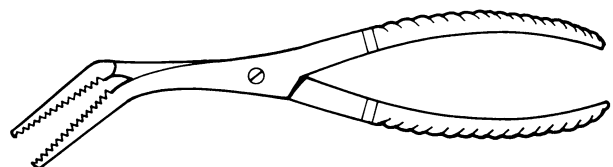

# Orthopaedic

## Bone Holding Forceps

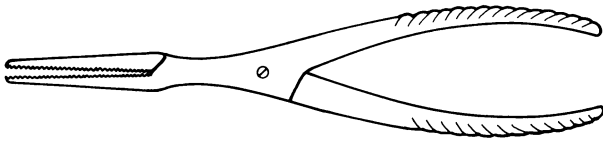

**51450-20** Necrosis (Sequestrum) Bone Holding Forcep, long fine jaws, screw joint, 200mm

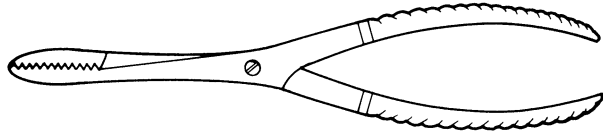

**51460-19** Necrosis (Sequestrum) Bone Holding Forcep, straight, screw joint, 190mm

**51460-20** Necrosis (Sequestrum) Bone Holding Forcep, straight, screw joint, 200mm

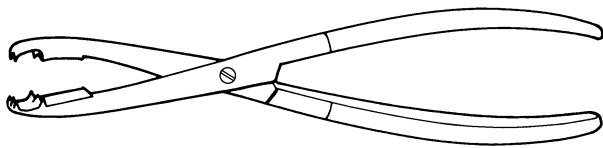

**51470-17** St. Thomas Bone Holding Forcep, screw joint, 175mm

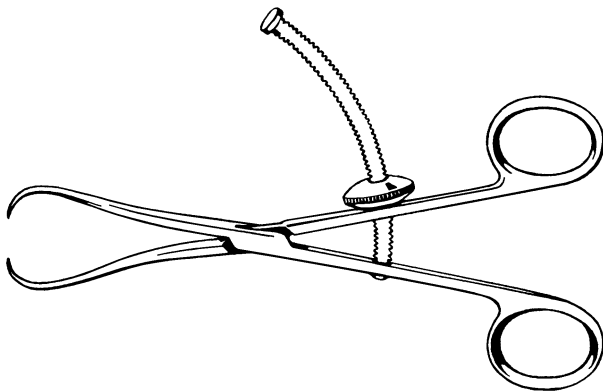

**51475-15** Tulloch Brown Bone Holding Forcep, 150mm

## Bone Hooks

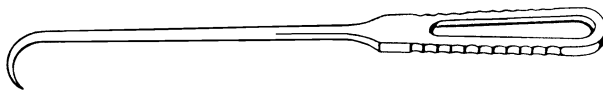

**51500-10** Kocher Bone Hook, sharp

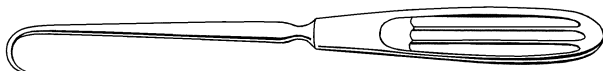

**51510-21** Langenbeck Bone Hook, blunt, 215mm

**51512-21** Langenbeck Bone Hook, sharp, 215mm

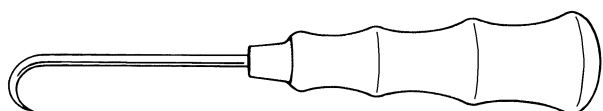

**51520-13** Harrison Bone Hook, sharp, aluminium handle, 130mm

51600-30 Bankhart Bone Levers, 300mm

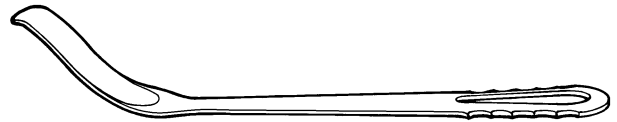

51610-44 Bennett 'Cobra' Bone Lever, small, 44mm at widest point, 240mm

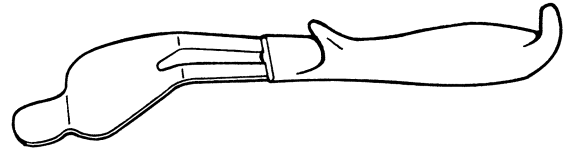

51610-57 Bennett 'Cobra' Bone Lever, large, 57mm at widest point, 240mm

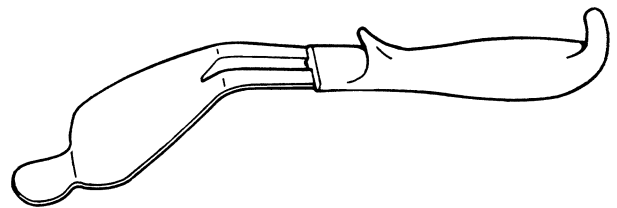

51620-35 Lane Bone Lever, heavy, solid handle, 355mm



51630-26 Lane Bone Lever, ring handle, 265mm

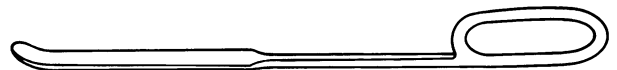

51640-26 Lane Bone Lever, serrated end, 260mm

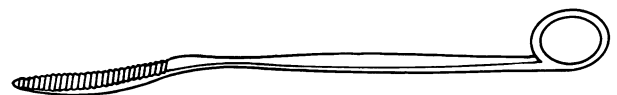

51645-32 Lane Bone Lever, Retractor And Guard, combined, 320mm



51650-33 Murphy Skid, 330mm

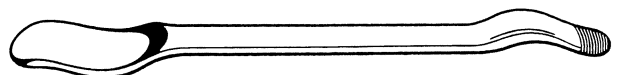

51651-33 Murphy Skid, insulated, 330mm

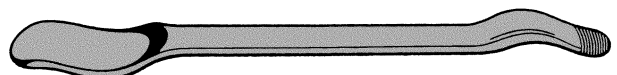

# Orthopaedic

## Bone Levers

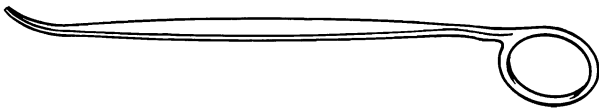

**51660-21** Trethowan Bone Lever, ring handle, 215mm

## Burs

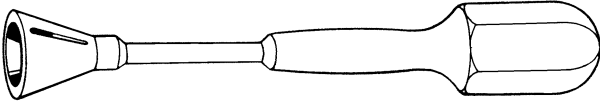

**51780-16** Marin Reamer And Bur, 160mm

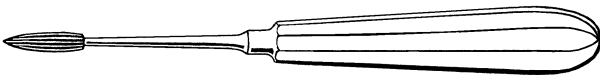
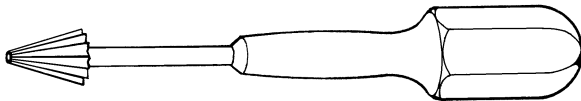

**51800-35** Paton Bur, 165mm, 3.5mm diameter

**51800-45** Paton Bur, 165mm, 4.5mm diameter

**51800-50** Paton Bur, 165mm, 5.0mm diameter

## Calipers

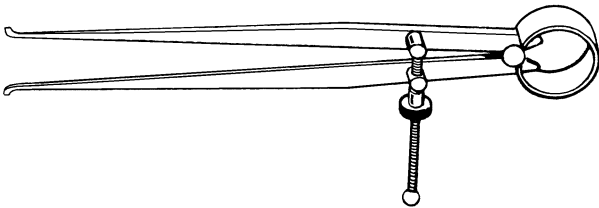

**51900-17** Albee Bone Caliper, inside measuring, nickel plated, 170mm

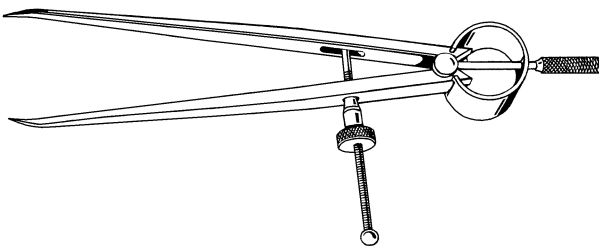

**51905-18** Albee Bone Caliper, dividers, nickel plated, 180mm



- 51910-18** Albee Bone Caliper, outside measuring, nickel plated, 180mm

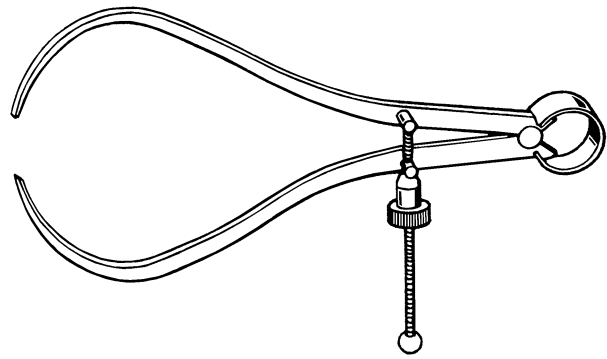

## Chisels

- 52100-06** Capener Chisel, tufnol handle, length 250mm, 6mm  
**52100-10** Capener Chisel, tufnol handle, length 250mm, 10mm  
**52100-12** Capener Chisel, tufnol handle, length 250mm, 12mm  
**52100-15** Capener Chisel, tufnol handle, length 250mm, 15mm  
**52100-20** Capener Chisel, tufnol handle, length 250mm, 20mm  
**52100-25** Capener Chisel, tufnol handle, length 250mm, 25mm  
**52100-30** Capener Chisel, tufnol handle, length 250mm, 30mm  
**52100-90** Capener Chisel, tufnol handle, length 250mm, set of 6

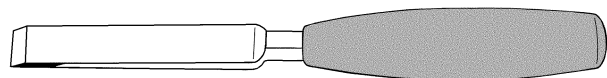

- 52105-05** French Chisel, with hard edge, 5mm  
**52105-07** French Chisel, with hard edge, 7mm  
**52105-09** French Chisel, with hard edge, 9mm  
**52105-11** French Chisel, with hard edge, 11mm

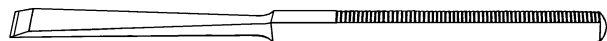

- 52110-10** Swedish Chisel, length 200mm, 10mm  
**52110-15** Swedish Chisel, length 200mm, 15mm  
**52110-20** Swedish Chisel, length 200mm, 20mm  
**52110-25** Swedish Chisel, length 200mm, 25mm  
**52110-30** Swedish Chisel, length 200mm, 30mm

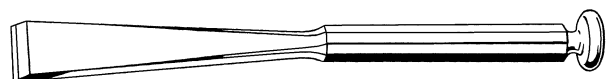

- 52111-02** Swedish Chisel, length 300mm, 2mm  
**52111-04** Swedish Chisel, length 300mm, 4mm  
**52111-06** Swedish Chisel, length 300mm, 6mm  
**52111-08** Swedish Chisel, length 300mm, 8mm  
**52111-10** Swedish Chisel, length 300mm, 10mm  
**52111-12** Swedish Chisel, length 300mm, 12mm



# Orthopaedic

## Compression Clamps

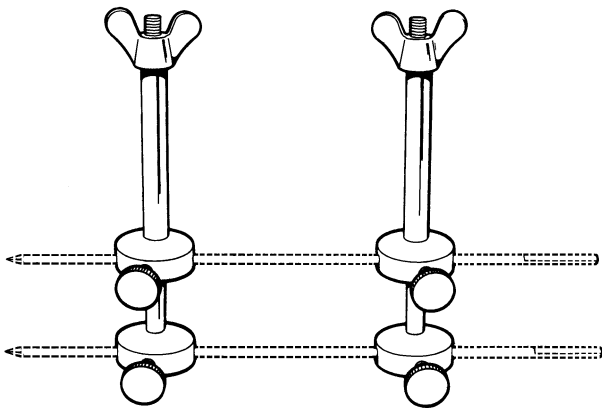

- 52180-40** Charnley Compression Clamp, to take 4mm pins, pair
- 52180-50** Charnley Compression Clamp, to take 5mm pins, pair

## Dislocating Hooks

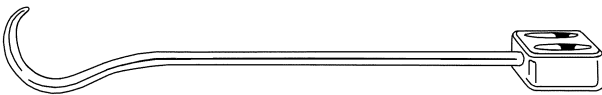

- 52200-10** Wroblenski Dislocating Hook, to hook around the neck of the femur

## Dissecting Forceps

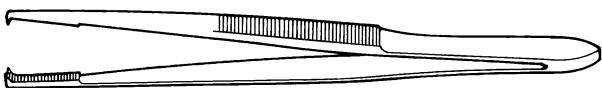

- 52300-14** Jackson Burrows Dissecting Forcep, serrated, 1/2 teeth, 140mm

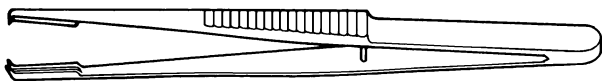

- 52310-14** Jackson Burrows Dissecting Forcep, with tongue and groove in jaw, 140mm

## Elevators

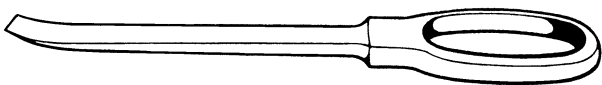

- 52400-23** Bristow Periosteal Elevator, sharp, 230mm

## Extractors

- 52450-20** Moore Femoral Head Extractor, with T handle, 205mm

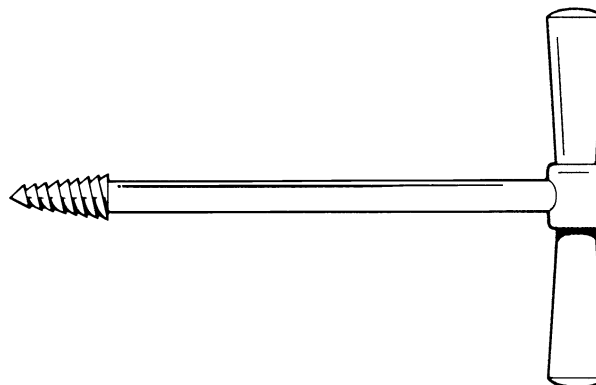

## Files

- 52500-30** Tubby File, 305mm



## Gouges

- 52550-04** Alexander Mastoid Gouge, with hard edge, length 155mm, 4mm  
**52550-06** Alexander Mastoid Gouge, with hard edge, length 155mm, 6mm  
**52550-08** Alexander Mastoid Gouge, with hard edge, length 155mm, 8mm  
**52550-10** Alexander Mastoid Gouge, with hard edge, length 155mm, 10mm  
**52550-12** Alexander Mastoid Gouge, with hard edge, length 155mm, 12mm  
**52550-14** Alexander Mastoid Gouge, with hard edge, length 155mm, 14mm

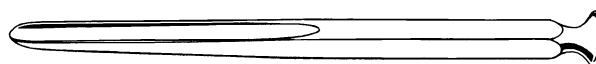

- 52600-30** Charnley Gouge, length 300mm

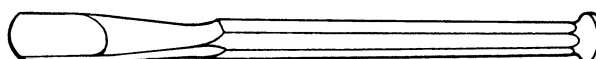

- 52610-10** Smith-Petersen Gouge, concave, toughened cutting edge, length 200mm, 10mm  
**52610-15** Smith-Petersen Gouge, concave, toughened cutting edge, length 200mm, 15mm  
**52610-20** Smith-Petersen Gouge, concave, toughened cutting edge, length 200mm, 20mm  
**52610-25** Smith-Petersen Gouge, concave, toughened cutting edge, length 200mm, 25mm



# Orthopaedic

## Gouges



- 52620-10** Smith-Petersen Gouge, straight, toughened cutting edge, length 200mm, 10mm
- 52620-15** Smith-Petersen Gouge, straight, toughened cutting edge, length 200mm, 15mm
- 52620-20** Smith-Petersen Gouge, straight, toughened cutting edge, length 200mm, 20mm
- 52620-25** Smith-Petersen Gouge, straight, toughened cutting edge, length 200mm, 25mm

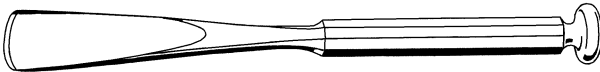

- 52630-06** Swedish Gouge, straight, length 200mm, 6mm
- 52630-08** Swedish Gouge, straight, length 200mm, 8mm
- 52630-10** Swedish Gouge, straight, length 200mm, 10mm
- 52630-12** Swedish Gouge, straight, length 200mm, 12mm
- 52630-15** Swedish Gouge, straight, length 200mm, 15mm
- 52630-20** Swedish Gouge, straight, length 200mm, 20mm
- 52630-25** Swedish Gouge, straight, length 200mm, 25mm
- 52630-30** Swedish Gouge, straight, length 200mm, 30mm

## Hand Splints

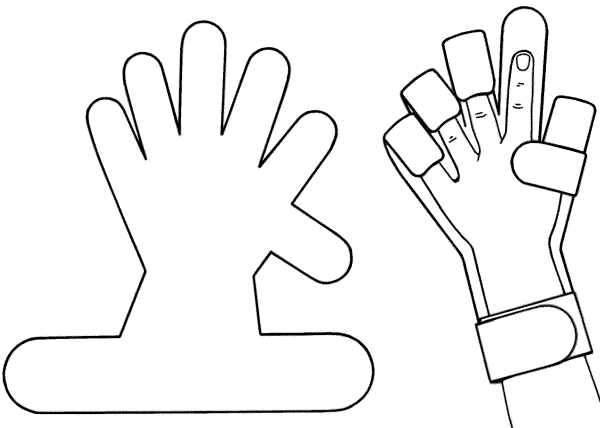

- 52900-25** Lead Hand Splint, small, with fold over tags for thumb and wrist, 250mm, 220mm
- 52900-38** Lead Hand Splint, large, with fold over tags for thumb and wrist, 380mm, 300mm
- 52901-33** Lead Hand Splint, mark 2, 1.2mm thick, large, with fold over tags for thumb and wrist, 335mm, 240mm

## Knives

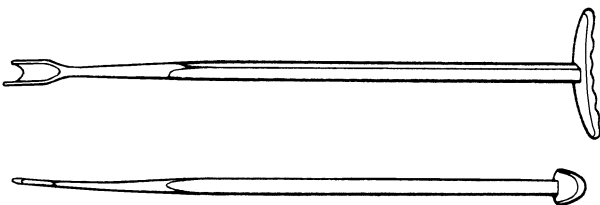

- 53160-17** Smillie Menisectomy Knife, curved to left, 175mm

## Knives

**53170-17** Smillie Menisectomy Knife, curved to right, 175mm

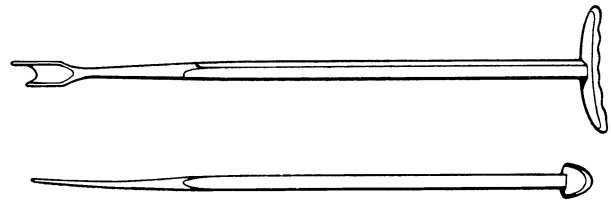

**53180-17** Smillie Menisectomy Knife, straight, 175mm

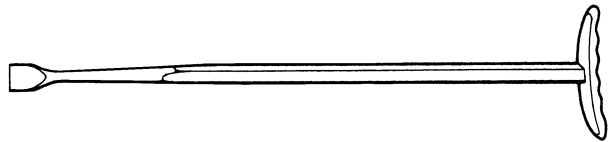

## Mallets

**53300-06** Cottle Mallet, s/s, 170g (6oz)

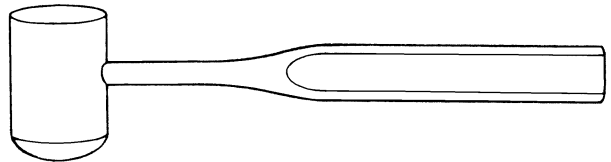

- 53310-18** Heath Mallet, copper head, s/p, 510g (18oz)
- 53310-28** Heath Mallet, copper head, s/p, 795g (28oz)
- 53310-32** Heath Mallet, copper head, s/p, 905g (32oz)
- 53310-36** Heath Mallet, copper head, s/p, 1020g (36oz)

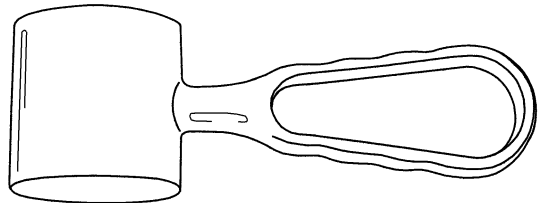

- 53311-18** Heath Mallet, s/s head, 510g (18oz)
- 53311-28** Heath Mallet, s/s head, 795g (28oz)
- 53311-32** Heath Mallet, s/s head, 905g (32oz)
- 53311-36** Heath Mallet, s/s head, 1020g (36oz)

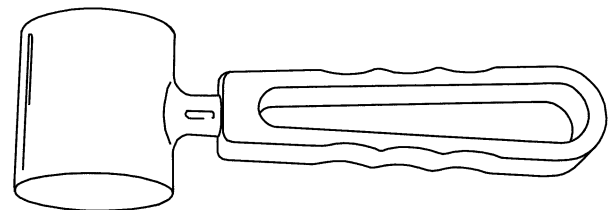

- 53315-14** Jamieson Mallet, s/s head and shaft, tufnol handle, 400g (14oz)
- 53315-27** Jamieson Mallet, s/s head and shaft, tufnol handle, 750g (27oz)

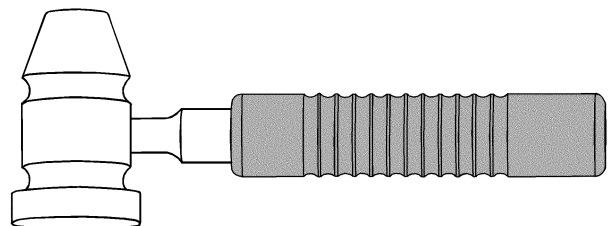

# Orthopaedic

## Mallets

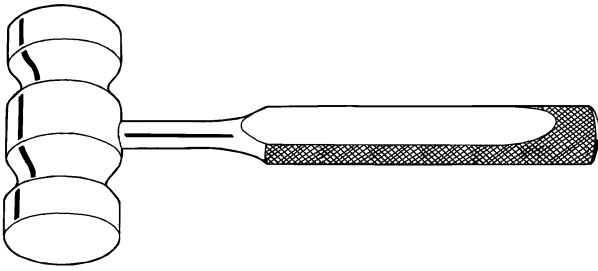

- 53317-16 London Splint Mallet, s/s, 450g (16oz)
- 53317-32 London Splint Mallet, s/s, 905g (32oz)

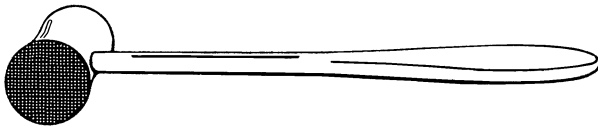

- 53320-08 Serrated One End Mallet, s/s, s/s handle, 190mm, 225g (8oz)

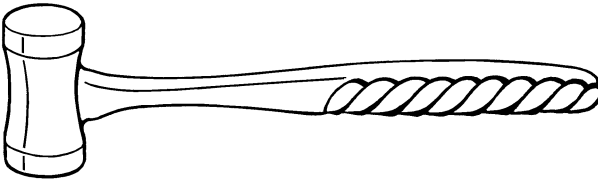

- 53325-18 Todd Mallet, s/s, 500g (18oz)

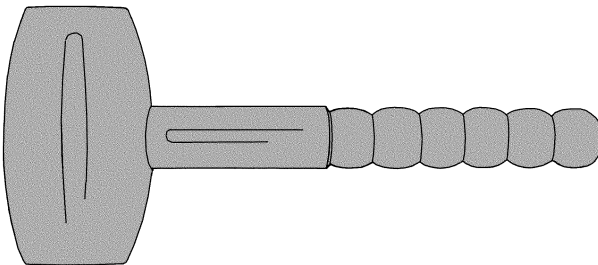

- 53330-10 Tufnol Mallet, barrel shaped, 500g (18oz)

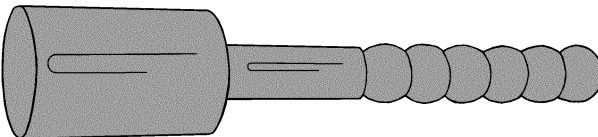

- 53340-18 Tufnol Mallet, stonemason pattern, 500g (18oz)

## Nail Instruments

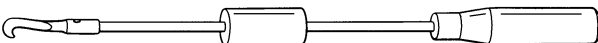

- 53410-15 Kuntscher Nail Extractor, 1.5mm hook to fit femur nails

- 53500-10** Capener Osteotome, curved, tufnol handle, 250mm, 10mm
- 53500-12** Capener Osteotome, curved, tufnol handle, 250mm, 12mm
- 53500-15** Capener Osteotome, curved, tufnol handle, 250mm, 15mm
- 53500-20** Capener Osteotome, curved, tufnol handle, 250mm, 20mm
- 53500-25** Capener Osteotome, curved, tufnol handle, 250mm, 25mm
- 53500-30** Capener Osteotome, curved, tufnol handle, 250mm, 30mm
- 53500-90** Capener Osteotome, curved, tufnol handle, 250mm, set of 6 (10mm - 30mm)

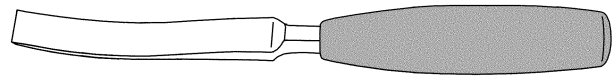

- 53510-05** Capener Osteotome, straight, tufnol handle, 250mm, 5mm
- 53510-06** Capener Osteotome, straight, tufnol handle, 250mm, 6mm
- 53510-10** Capener Osteotome, straight, tufnol handle, 250mm, 10mm
- 53510-12** Capener Osteotome, straight, tufnol handle, 250mm, 12mm
- 53510-15** Capener Osteotome, straight, tufnol handle, 250mm, 15mm
- 53510-20** Capener Osteotome, straight, tufnol handle, 250mm, 20mm
- 53510-25** Capener Osteotome, straight, tufnol handle, 250mm, 25mm
- 53510-30** Capener Osteotome, straight, tufnol handle, 250mm, 30mm
- 53510-38** Capener Osteotome, straight, tufnol handle, 250mm, 38mm
- 53510-90** Capener Osteotome, straight, tufnol handle, 250mm, set of 6 (10mm - 30mm)

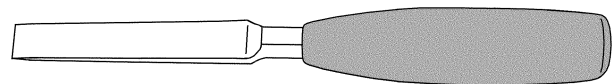

- 53515-10** MacEwen Osteotome, toughened cutting edge, 190mm, 10mm
- 53515-13** MacEwen Osteotome, toughened cutting edge, 190mm, 13mm
- 53515-20** MacEwen Osteotome, toughened cutting edge, 190mm, 20mm
- 53515-25** MacEwen Osteotome, toughened cutting edge, 190mm, 25mm
- 53515-30** MacEwen Osteotome, toughened cutting edge, 190mm, 30mm

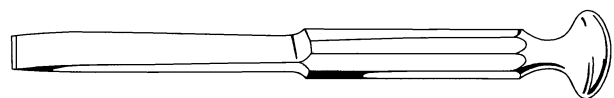

# Orthopaedic

## Osteotomes

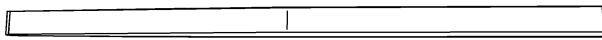

- 53518-02** Lambotte Mini Osteotome, straight, 140mm, 2mm
- 53518-03** Lambotte Mini Osteotome, straight, 140mm, 3mm
- 53518-04** Lambotte Mini Osteotome, straight, 140mm, 4mm
- 53518-05** Lambotte Mini Osteotome, straight, 140mm, 5mm
- 53518-06** Lambotte Mini Osteotome, straight, 140mm, 6mm
- 53518-07** Lambotte Mini Osteotome, straight, 140mm, 7mm
- 53518-08** Lambotte Mini Osteotome, straight, 140mm, 8mm
- 53518-09** Lambotte Mini Osteotome, straight, 140mm, 9mm
- 53518-10** Lambotte Mini Osteotome, straight, 140mm, 10mm
- 53518-11** Lambotte Mini Osteotome, straight, 140mm, 11mm
- 53518-12** Lambotte Mini Osteotome, straight, 140mm, 12mm

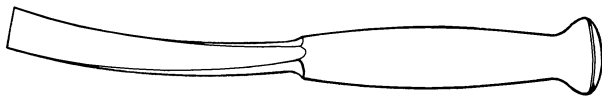

- 53520-10** Smith-Petersen Osteotome, curved, toughened cutting edge, 200mm, 10mm
- 53520-15** Smith-Petersen Osteotome, curved, toughened cutting edge, 200mm, 15mm
- 53520-20** Smith-Petersen Osteotome, curved, toughened cutting edge, 200mm, 20mm
- 53520-25** Smith-Petersen Osteotome, curved, toughened cutting edge, 200mm, 25mm
- 53520-30** Smith-Petersen Osteotome, curved, toughened cutting edge, 200mm, 30mm

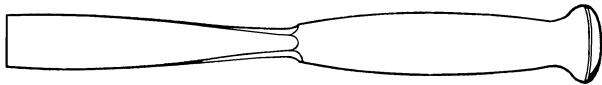

- 53530-10** Smith-Petersen Osteotome, straight, toughened cutting edge, 200mm, 10mm
- 53530-15** Smith-Petersen Osteotome, straight, toughened cutting edge, 200mm, 15mm
- 53530-20** Smith-Petersen Osteotome, straight, toughened cutting edge, 200mm, 20mm
- 53530-25** Smith-Petersen Osteotome, straight, toughened cutting edge, 200mm, 25mm
- 53530-30** Smith-Petersen Osteotome, straight, toughened cutting edge, 200mm, 30mm

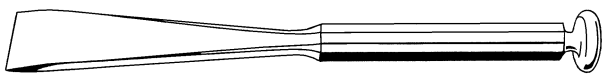

- 53540-10** Swedish Osteotome, straight, 200mm, 10mm
- 53540-13** Swedish Osteotome, straight, 200mm, 13mm
- 53540-15** Swedish Osteotome, straight, 200mm, 15mm
- 53540-20** Swedish Osteotome, straight, 200mm, 20mm
- 53540-25** Swedish Osteotome, straight, 200mm, 25mm
- 53540-30** Swedish Osteotome, straight, 200mm, 30mm

## Plate Benders

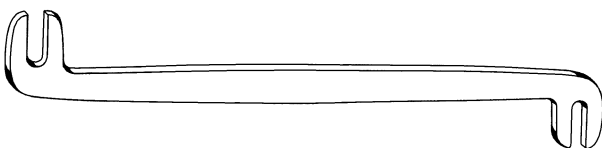

- 53700-20** Lane Plate Bender, slotted, 200mm, set of 2



## Plate Benders

**53710-22** Lane Plate Bender, with pins, 225mm, set of 2

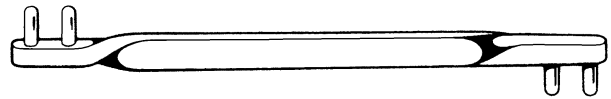

## Punches

**53790-13** Fleming Bone Graft Punch, 130mm

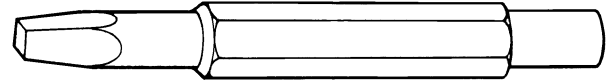

**53800-10** McGoey Punch, double ended, No.1, 19mm x 13mm



**53800-20** McGoey Punch, double ended, No.2, 10mm x 6mm



**53800-30** McGoey Punch, double ended, No.3, 13mm x 6mm with flats



**53810-10** Smillie Punch, angled

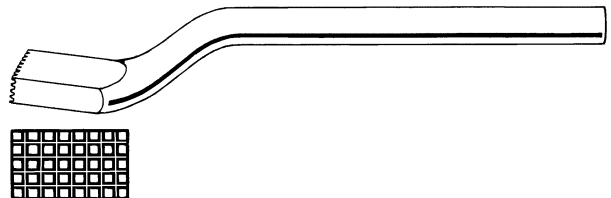

**53820-10** Smillie Punch, straight

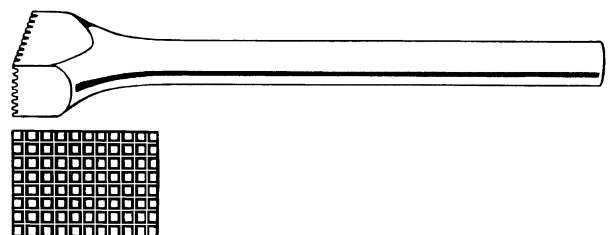

## Raspatories

**53860-18** St.Thomas Hospital Raspatory, pointed end, 180mm

**53870-18** St.Thomas Hospital Raspatory, rounded end, 180mm

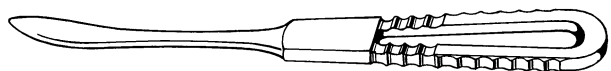

# Orthopaedic

## Rasps

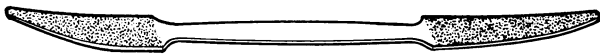

**53930-27** Putti Rasp, flat both ends, 270mm

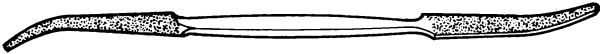

**53940-30** Putti Rasp, rounded one end, 300mm

## Retractors

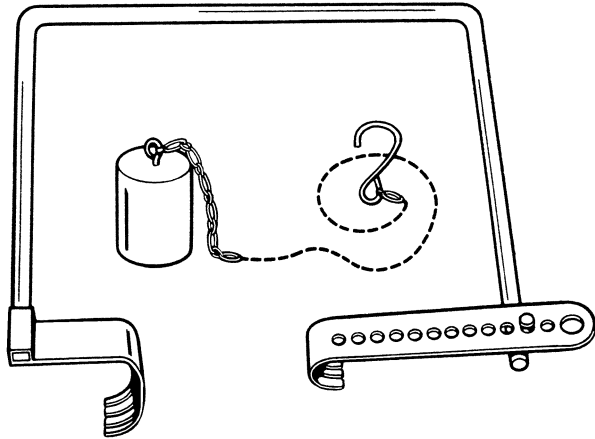

**54000-10** Charnley Initial Incision Retractor, frame only

**54000-20** Charnley Initial Incision Retractor, weight and chain with hooks only

**54000-30** Charnley Initial Incision Retractor, weight only

**54000-40** Charnley Initial Incision Retractor, chain with hooks only

**54000-50** Charnley Initial Incision Retractor, blade with square fitting only, standard, 50mm

**54000-55** Charnley Initial Incision Retractor, blade with square fitting only, extra deep, 75mm

**54000-57** Charnley Initial Incision Retractor, blade with square fitting only, extra extra deep, 100mm

**54000-60** Charnley Initial Incision Retractor, blade with round fitting only, standard, 40mm

**54000-65** Charnley Initial Incision Retractor, blade with round fitting only, extra deep, 75mm

**54000-67** Charnley Initial Incision Retractor, blade with round fitting only, extra extra deep, 100mm

**54000-80** Charnley Initial Incision Retractor, complete, standard, without weight and chain, 305mm

**54000-90** Charnley Initial Incision Retractor, complete, standard, with weight and chain, 305mm

**54000-95** Charnley Initial Incision Retractor, complete, extra deep, with weight and chain, 305mm

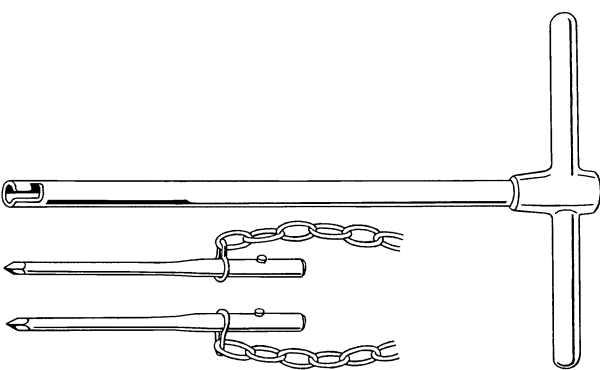

**54005-10** Charnley Pin Retractor, T handle only, 210mm

**54005-50** Charnley Pin Retractor, pins only, 105mm, pair, connected by 410mm long chain

**54005-90** Charnley Pin Retractor, complete, T handle and pair of pins connected by chain

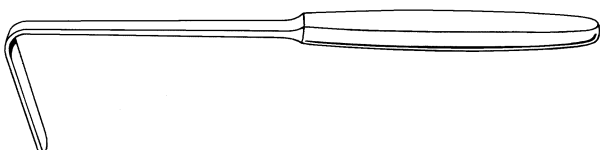

**54010-21** Charnley Knee Retractor, 215mm, 50mm x 6mm blade

- 54020-08** Hohmann-Muller Spike Retractor, 8mm
- 54020-18** Hohmann-Muller Spike Retractor, 18mm
- 54020-43** Hohmann-Muller Spike Retractor, 43mm
- 54020-70** Hohmann-Muller Spike Retractor, 70mm

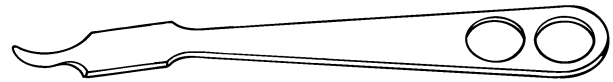

- 54030-22** Jackson Burrows Retractor, broad angled, 220mm

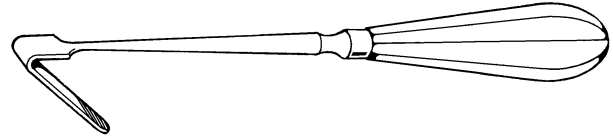

- 54040-22** Jackson Burrows Retractor, narrow, curved, 220mm

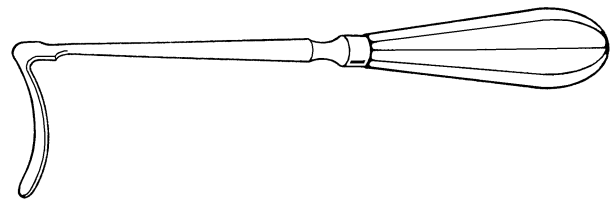

- 54050-10** Rowe Boat Hook Retractor



- 54060-10** Smillie Knee Joint Retractor, blade 'A' only, straight blade, 150mm, 20mm x 60mm

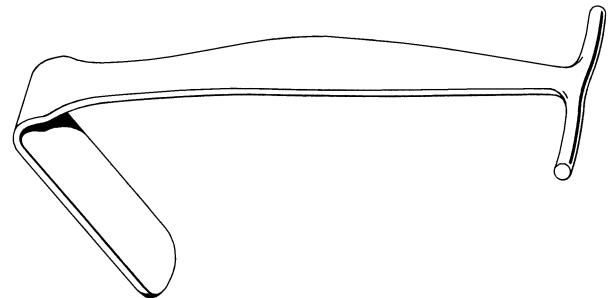

- 54060-20** Smillie Knee Joint Retractor, blade 'B' only, straight blade, 150mm, 20mm x 40mm

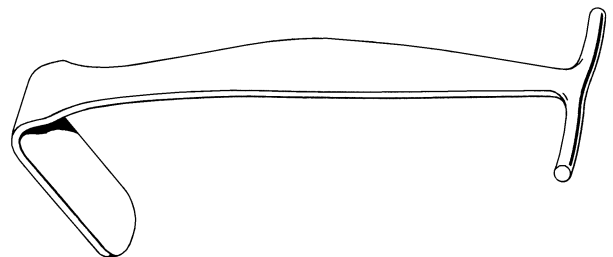

# Orthopaedic

## Retractors

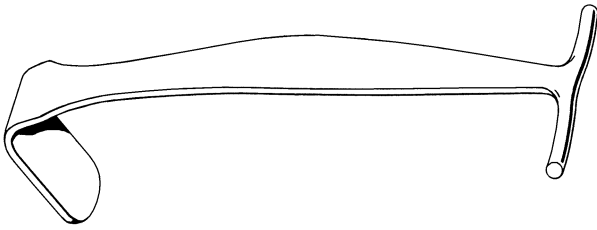

**54060-30** Smillie Knee Joint Retractor, blade 'C' only, straight blade, 150mm, 17mm x 30mm

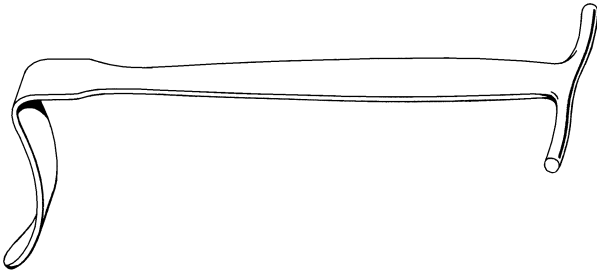

**54060-40** Smillie Knee Joint Retractor, blade 'D' only, reverse curved blade, 150mm, 13mm x 45mm

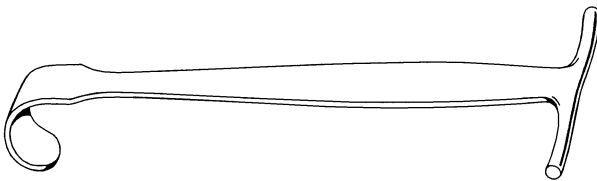

**54060-50** Smillie Knee Joint Retractor, blade 'E' only, curved blade, 150mm, 13mm x 20mm

**54060-90** Smillie Knee Joint Retractor, set of 6 (1 x blades A B C D, 2 x blade E)

## Retractors - Self Retaining

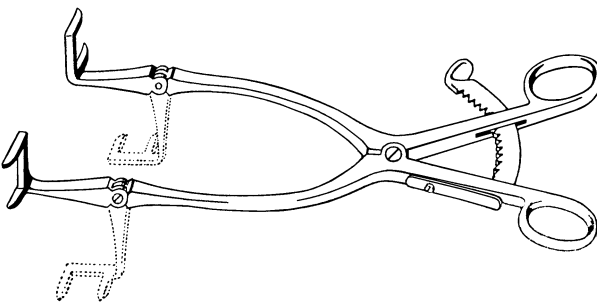

**54090-27** Charnley Horizontal Self Retaining Retractor, hinged horizontal arms 50mm long, 275mm

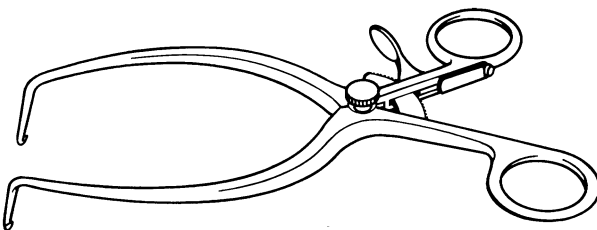

**54100-17** Jackson Burrows Self Retaining Retractor, 175mm

**54200-18** Jansen Rongeur, curved, compound action, 180mm

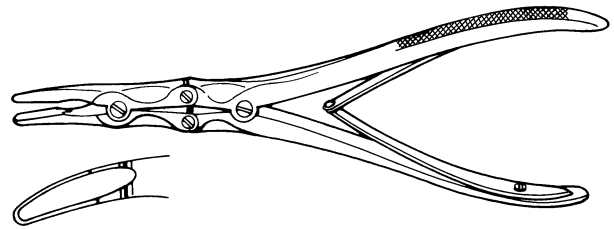

**54210-04** Leksell Rongeur, compound action, 230mm, 4mm jaw

**54210-06** Leksell Rongeur, compound action, 230mm, 6mm jaw

**54210-08** Leksell Rongeur, compound action, 230mm, 8mm jaw

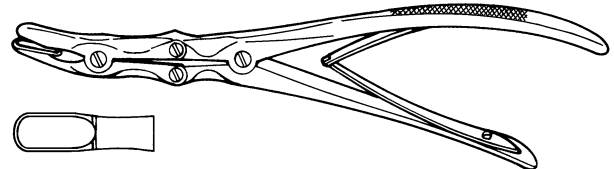

**54220-16** Lempert Rongeur, curved, 160mm

**54220-19** Lempert Rongeur, curved, 190mm

**54230-19** Lempert Rongeur, straight, 190mm

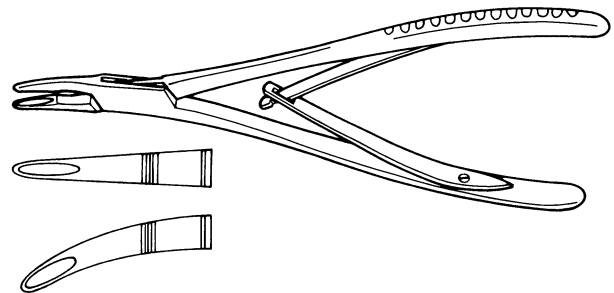

**54240-15** Luer Rongeur, curved, small, 150mm

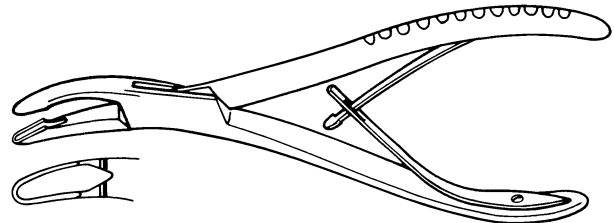

**54240-17** Luer Rongeur, curved, large, 170mm

**54250-17** Luer Rongeur, straight, large, 170mm

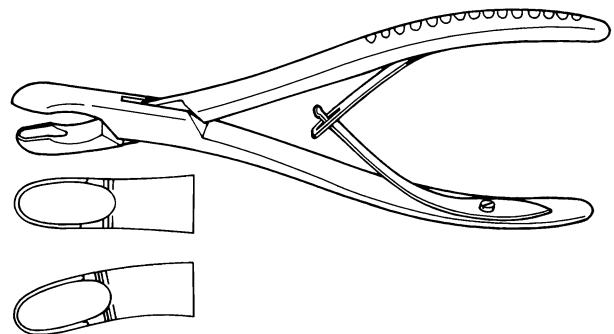

# Orthopaedic

## Rugines

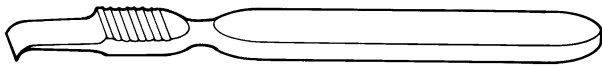

54300-15 Farabeuf Rugin, curved, flat handle, 150mm

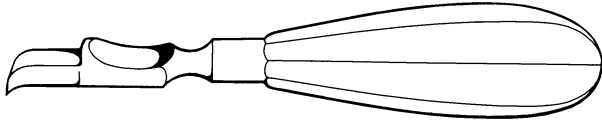

54310-16 Farabeuf Rugin, curved, hollow handle, 160mm

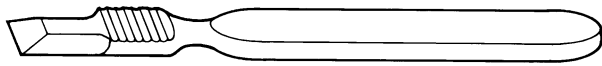

54320-15 Farabeuf Rugin, straight, flat handle, 150mm

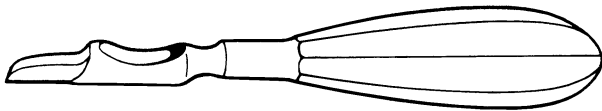

54330-16 Farabeuf Rugin, straight, hollow handle, 160mm

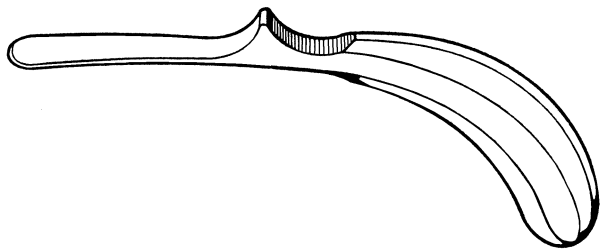

54340-18 Jones Rugin, pistol handle, fan shape, 185mm

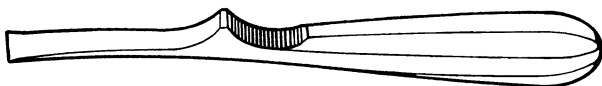

54350-10 Mitchell Rugin, hollow handle, fan shaped, straight sharp edge, 190mm

## Screw Holding Forceps

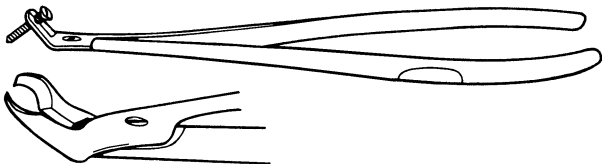

54400-23 Lane Screw Holding Forcep, screw joint, 235mm

## Screw Jacks

**54450-10** Charnley Screw Jack, for horizontal retractor

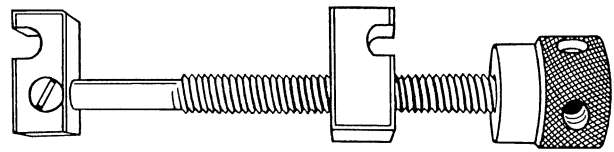

## Screwdrivers

**54500-04** Lane Screwdriver, for single slot screws, hollow handle, 280mm, 4mm wide

**54500-05** Lane Screwdriver, for single slot screws, hollow handle, 280mm, 5mm wide

**54500-06** Lane Screwdriver, for single slot screws, hollow handle, 280mm, 6mm wide

**54501-04** Lane Screwdriver, for single slot screws, solid handle, 280mm, 4mm wide

**54501-05** Lane Screwdriver, for single slot screws, solid handle, 280mm, 5mm wide

**54501-06** Lane Screwdriver, for single slot screws, solid handle, 280mm, 6mm wide



**54510-28** Lane Screwdriver, for Phillips screws, hollow handle, 285mm

**54511-28** Lane Screwdriver, for Phillips screws, solid handle, 285mm

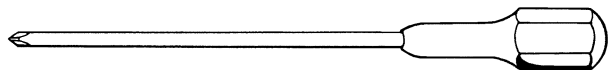

**54530-24** Williams Self Retaining Screwdriver, for single slot screws, 240mm

**54531-24** Williams Self Retaining Screwdriver, for Phillips screws, 240mm

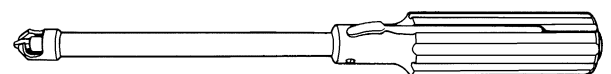

## Staple Instruments

**54600-16** Blount Staple Driver, for large, small and wide staples, 160mm

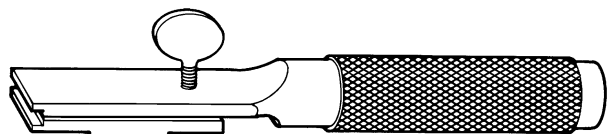

**54610-15** Blount Staple Remover, 150mm



**54620-16** Blount Staple Set, 165mm



# Orthopaedic

## Staple Instruments

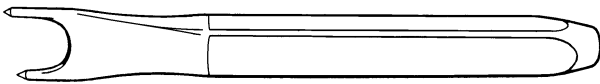

**54630-16** Blount Staple Starter, 160mm, for 16mm staples

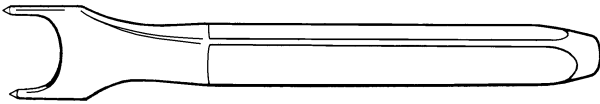

**54630-22** Blount Staple Starter, 160mm, for 22mm staples

## Stirrups

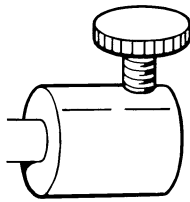

**54800-22** Bohler Stirrup, pin mount, for 4mm and 6mm pins, 22mm

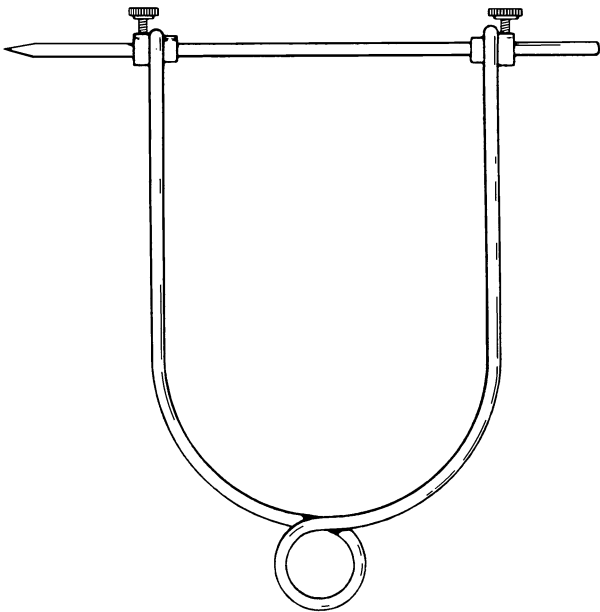

**54810-10** Bohler Stirrup, rotating with swivel fixation pieces, small, 100mm, 90mm

**54810-16** Bohler Stirrup, rotating with swivel fixation pieces, medium, 165mm, 115mm

**54810-24** Bohler Stirrup, rotating with swivel fixation pieces, large, 240mm, 150mm

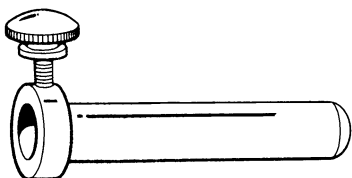

**54820-10** Steinmann Pin Cap, to shield ends of 4mm and 6mm pins



Suture Forceps

- 54900-14 Charnley Suture Forcep, slotted, 1/2 teeth, 145mm
- 54900-18 Charnley Suture Forcep, slotted, 1/2 teeth, 180mm

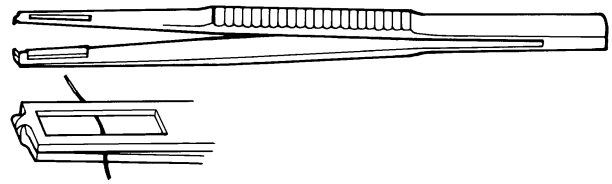

Tendon Hooks

- 55000-11 Harlow Wood Tendon Hook, with bow handle, 115mm



Tendon Instruments

- 55100-15 Anderson Tunnelling Forcep, curved, 150mm
- 55100-24 Anderson Tunnelling Forcep, curved, 240mm

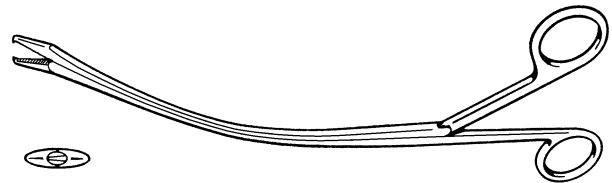

- 55110-20 Anderson Tunnelling Forcep, straight, 200mm
- 55110-24 Anderson Tunnelling Forcep, straight, 240mm

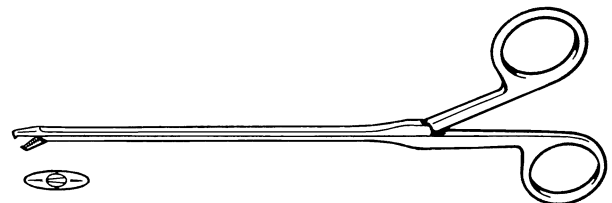

- 55130-52 Brand Plantaris Stripper, 525mm

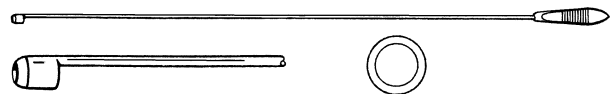

- 55135-40 Furlong Tendon Stripper, 200mm, 4mm bore
- 55135-50 Furlong Tendon Stripper, 200mm, 5mm bore



- 55140-10 Moseley Fasciotome, s/s

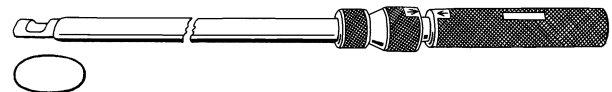

# Orthopaedic

## Tendon Instruments

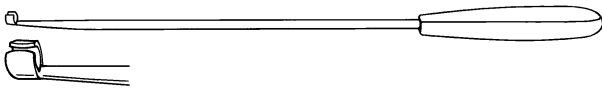

**55150-38** Mustarde Fascia Splitter, 380mm

## Twist Drills



- 51739-19** Morse Twist Drill, 75mm long, 1.9mm diameter
- 51739-23** Morse Twist Drill, 75mm long, 2.3mm diameter
- 51739-27** Morse Twist Drill, 75mm long, 2.7mm diameter
- 51739-31** Morse Twist Drill, 75mm long, 3.1mm diameter
- 51739-35** Morse Twist Drill, 75mm long, 3.5mm diameter
- 51739-39** Morse Twist Drill, 75mm long, 3.9mm diameter
- 51740-19** Morse Twist Drill, 125mm long, 1.9mm diameter
- 51740-23** Morse Twist Drill, 125mm long, 2.3mm diameter
- 51740-27** Morse Twist Drill, 125mm long, 2.7mm diameter
- 51740-31** Morse Twist Drill, 125mm long, 3.1mm diameter
- 51740-35** Morse Twist Drill, 125mm long, 3.5mm diameter
- 51740-39** Morse Twist Drill, 125mm long, 3.9mm diameter

## Wire Instruments

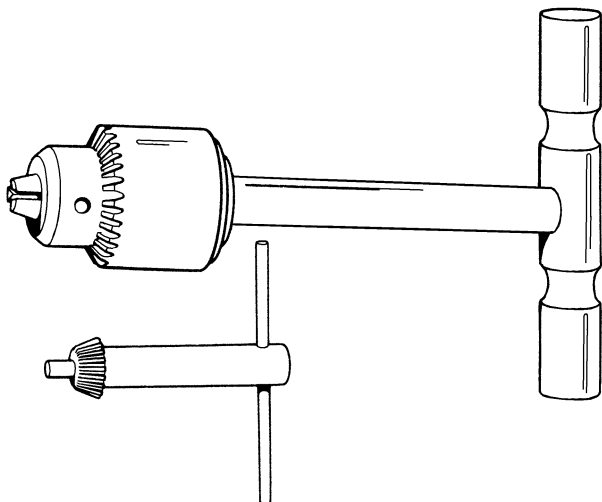

- 55300-10** Bone Pin Chuck, on T handle, c/w chuck key, 100mm
- 55300-50** Bone Pin Chuck, chuck only, c/w chuck key

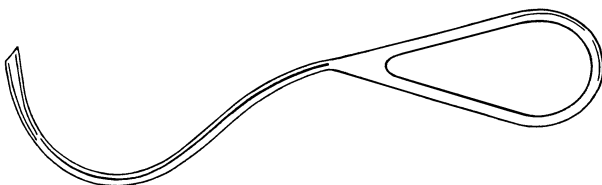

**55302-17** Chamley Wire Passer, 175mm

**55305-14** Watson Jones Introducer, for 2.5mm diameter guide wires, 140mm

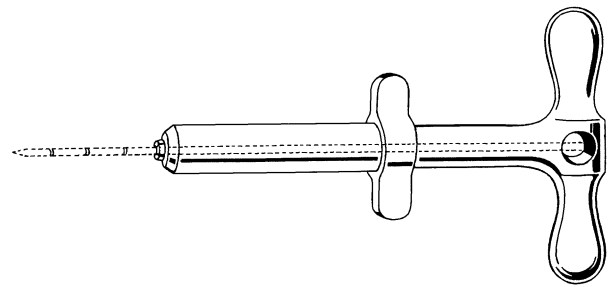

**55310-16** Kirschner Wire Cutter / Plier, c/p, 165mm

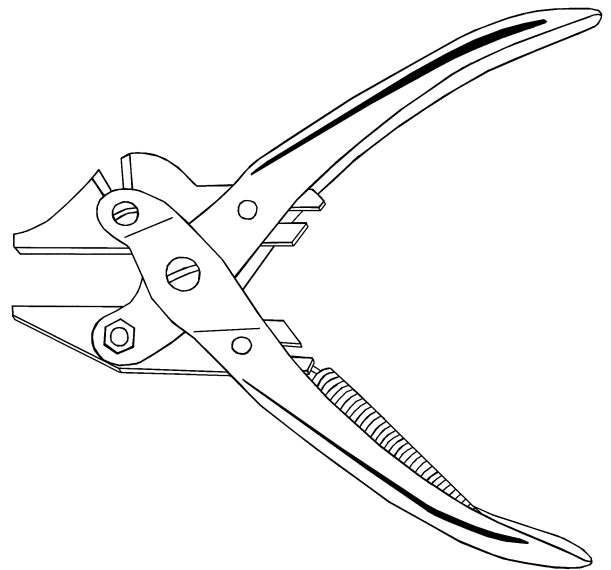

# Gynaecology and Obstetrics

## Cannulae

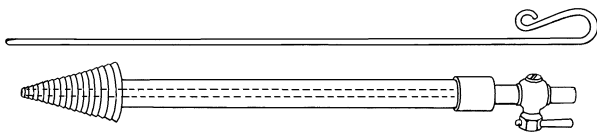

**60920-20** Fraser Wilkinson Intra Uterine Cannula, with stillette, perspex, with metal stopcock, 205mm

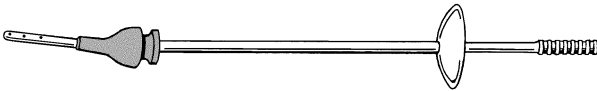

**61000-27** Hayes-Provis Intra Uterine Cannula, rubber cone, 275mm

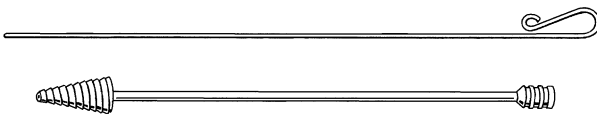

**61010-10** Leech Wilkinson Intra Uterine Cannula, with stillette, luer cone, 265mm, 10mm at base



**61010-13** Leech Wilkinson Intra Uterine Cannula, with stillette, luer cone, 265mm, 13mm at base



**61010-16** Leech Wilkinson Intra Uterine Cannula, with stillette, luer cone, 265mm, 16mm at base

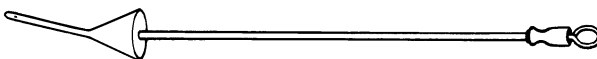

**61020-27** Provis Intra Uterine Cannula, 275mm



**61030-14** Spackman Intra Uterine Cannula, with adjustable plate, 360mm, metal cone, 14FG

**61030-18** Spackman Intra Uterine Cannula, with adjustable plate, 360mm, metal cone, 18FG

**61035-14** Spackman Intra Uterine Cannula, with adjustable plate, 360mm, rubber cone, 14FG

**61035-18** Spackman Intra Uterine Cannula, with adjustable plate, 360mm, rubber cone, 18FG

**61035-50** Spackman Intra Uterine Cannula, rubber cone only

## Catheters

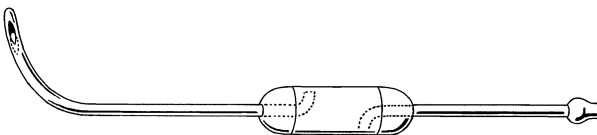

**61040-23** Carton-Cowell Catheter, lateral holes, 230mm

- 61060-16** Female Catheter, oval, with solid end, s/p, 165mm
- 61070-06** Female Catheter, round, with solid end, s/p, 165mm, 6EG
- 61070-07** Female Catheter, round, with solid end, s/p, 165mm, 7EG
- 61070-08** Female Catheter, round, with solid end, s/p, 165mm, 8EG
- 61070-09** Female Catheter, round, with solid end, s/p, 165mm, 9EG
- 61070-10** Female Catheter, round, with solid end, s/p, 165mm, 10EG
- 61070-12** Female Catheter, round, with solid end, s/p, 165mm, 12EG
- 61075-06** Female Catheter, round, with solid end, silver, 165mm, 6EG
- 61075-07** Female Catheter, round, with solid end, silver, 165mm, 7EG
- 61075-08** Female Catheter, round, with solid end, silver, 165mm, 8EG
- 61075-09** Female Catheter, round, with solid end, silver, 165mm, 9EG
- 61075-10** Female Catheter, round, with solid end, silver, 165mm, 10EG
- 61075-12** Female Catheter, round, with solid end, silver, 165mm, 12EG

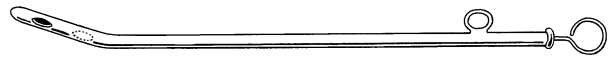

- 61080-08** Rotunda Catheter, round, with solid end, s/s, 200mm, 8EG
- 61080-09** Rotunda Catheter, round, with solid end, s/s, 200mm, 9EG
- 61080-10** Rotunda Catheter, round, with solid end, s/s, 200mm, 10EG



## Clamps

- 61100-20** Berkeley-Bonney Hysterectomy Clamp, curved on flat, 1/2 teeth, 200mm

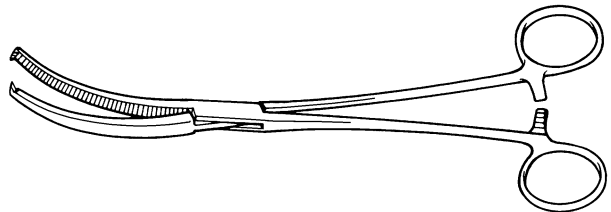

- 61110-19** Bonney Hysterectomy Clamp, angled on flat, 1/2 teeth, 195mm

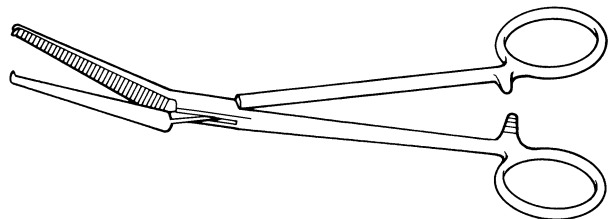

## Clamps

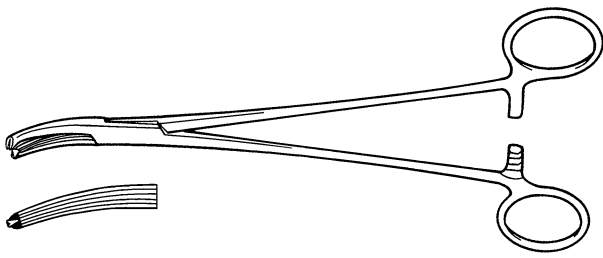

**61120-20** Faure Clamp, toothed, 200mm

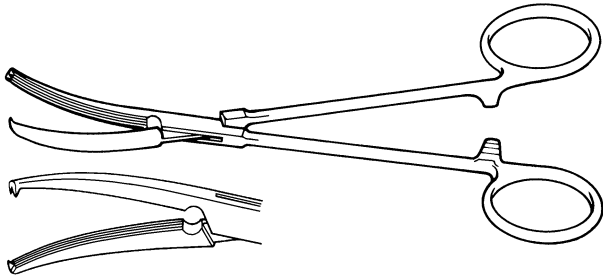

**61130-20** Gwilliam Clamp, curved on flat, longitudinal serrations, 1/2 teeth, 200mm

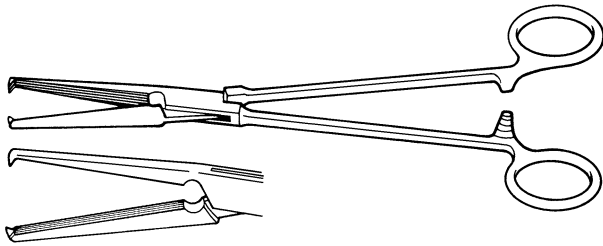

**61140-20** Gwilliam Clamp, straight, longitudinal serrations, 1/2 teeth, 200mm

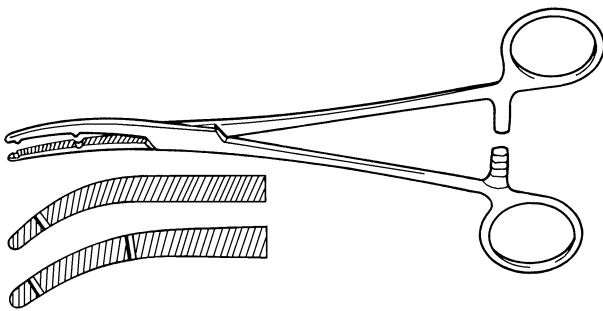

**61150-21** Heaney Clamp, curved, double tooth, 210mm

**61160-21** Heaney Clamp, curved, single tooth, 210mm

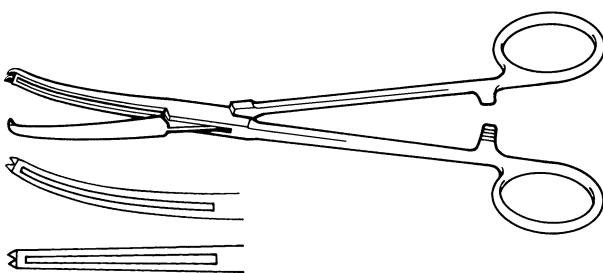

**61170-20** Maingot Clamp, curved on flat, 1/2 teeth, 205mm

**61170-24** Maingot Clamp, curved on flat, 1/2 teeth, 240mm

**61180-20** Maingot Clamp, straight, 1/2 teeth, 205mm

**61180-24** Maingot Clamp, straight, 1/2 teeth, 240mm

## Clamps - Atraumatic

- 61200-21** DeBakey Hysterectomy Atraumatic Clamp, angled, 2/3 teeth, 210mm
- 61200-23** DeBakey Hysterectomy Atraumatic Clamp, angled, 2/3 teeth, 230mm
- 61210-21** DeBakey Hysterectomy Atraumatic Clamp, deep curve, 2/3 teeth, 220mm
- 61210-23** DeBakey Hysterectomy Atraumatic Clamp, deep curve, 2/3 teeth, 240mm
- 61220-22** DeBakey Hysterectomy Atraumatic Clamp, slight curve, 2/3 teeth, 220mm
- 61220-24** DeBakey Hysterectomy Atraumatic Clamp, slight curve, 2/3 teeth, 240mm
- 61230-22** DeBakey Hysterectomy Atraumatic Clamp, straight, 2/3 teeth, 220mm
- 61230-24** DeBakey Hysterectomy Atraumatic Clamp, straight, 2/3 teeth, 240mm

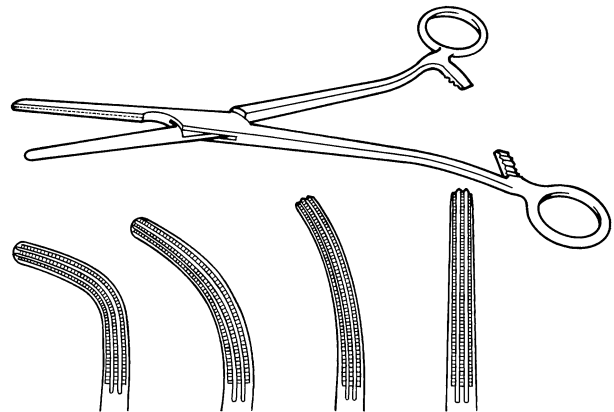

## Curettes

- 61310-26** Horrocks Uterine Curette, fine, semi-blunt, 260mm

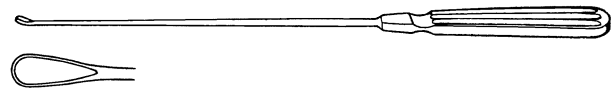

- 61320-25** Novak Suction Curette, 250mm

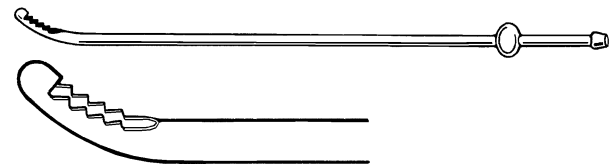

- 61330-24** Randall Curette, 240mm

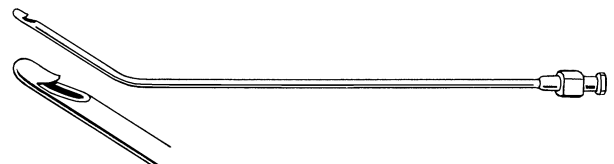

- 61340-08** Rheinstadter Uterine Flushing Curette, blunt edge, 8mm
- 61340-11** Rheinstadter Uterine Flushing Curette, blunt edge, 11mm
- 61340-14** Rheinstadter Uterine Flushing Curette, blunt edge, 14mm
- 61350-08** Rheinstadter Uterine Flushing Curette, sharp edge, 8mm
- 61350-11** Rheinstadter Uterine Flushing Curette, sharp edge, 11mm
- 61350-14** Rheinstadter Uterine Flushing Curette, sharp edge, 14mm

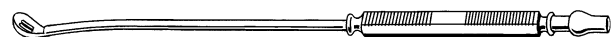

# Gynaecology and Obstetrics

## Curettes

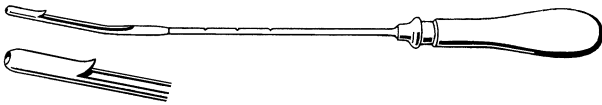

**61360-22** Sharman Endometrial Curette, 220mm



**61370-25** Sims Uterine Curette, double ended, blunt / sharp combined, 250mm

**61390-25** Sims Uterine Curette, double ended, sharp / sharp combined, 250mm

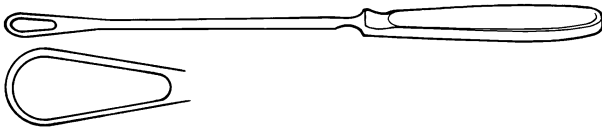

**61380-06** Sims Uterine Curette, blunt, pliable shaft, 255mm, 6mm

**61380-10** Sims Uterine Curette, blunt, pliable shaft, 255mm, 10mm

**61380-13** Sims Uterine Curette, blunt, pliable shaft, 255mm, 13mm

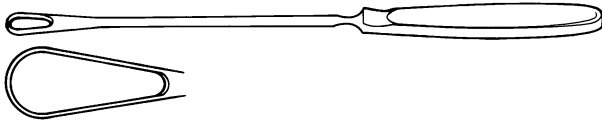

**61400-06** Sims Uterine Curette, sharp, pliable shaft, 255mm, 6mm

**61400-10** Sims Uterine Curette, sharp, pliable shaft, 255mm, 10mm

**61400-13** Sims Uterine Curette, sharp, pliable shaft, 255mm, 13mm

## Dilators

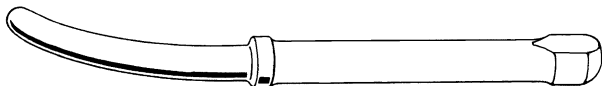

**61570-05** Bonney Barker Dilator, s/s, 190mm, 3/5mm

**61570-06** Bonney Barker Dilator, s/s, 190mm, 4/6mm

**61570-07** Bonney Barker Dilator, s/s, 190mm, 5/7mm

**61570-08** Bonney Barker Dilator, s/s, 190mm, 6/8mm

**61570-09** Bonney Barker Dilator, s/s, 190mm, 7/9mm

**61570-10** Bonney Barker Dilator, s/s, 190mm, 8/10mm

**61570-11** Bonney Barker Dilator, s/s, 190mm, 9/11mm

**61570-12** Bonney Barker Dilator, s/s, 190mm, 10/12mm

**61570-13** Bonney Barker Dilator, s/s, 190mm, 11/13mm

**61570-14** Bonney Barker Dilator, s/s, 190mm, 12/14mm

**61570-15** Bonney Barker Dilator, s/s, 190mm, 13/15mm

**61570-16** Bonney Barker Dilator, s/s, 190mm, 14/16mm

**61570-17** Bonney Barker Dilator, s/s, 190mm, 15/17mm

**61570-18** Bonney Barker Dilator, s/s, 190mm, 16/18mm

**61570-19** Bonney Barker Dilator, s/s, 190mm, 17/19mm

**61570-20** Bonney Barker Dilator, s/s, 190mm, 18/20mm

**61570-85** Bonney Barker Dilator, s/s, 190mm, set of 8 (3/5mm - 10/12mm)

**61570-90** Bonney Barker Dilator, s/s, 190mm, set of 16 (3/5mm - 18/20mm)



- 61600-06** Hawkin Ambler Dilator, conical, 170mm, 3/6mm  
**61600-07** Hawkin Ambler Dilator, conical, 170mm, 4/7mm  
**61600-08** Hawkin Ambler Dilator, conical, 170mm, 5/8mm  
**61600-09** Hawkin Ambler Dilator, conical, 170mm, 6/9mm  
**61600-10** Hawkin Ambler Dilator, conical, 170mm, 7/10mm  
**61600-11** Hawkin Ambler Dilator, conical, 170mm, 8/11mm  
**61600-12** Hawkin Ambler Dilator, conical, 170mm, 9/12mm  
**61600-13** Hawkin Ambler Dilator, conical, 170mm, 10/13mm  
**61600-14** Hawkin Ambler Dilator, conical, 170mm, 11/14mm  
**61600-15** Hawkin Ambler Dilator, conical, 170mm, 12/15mm  
**61600-16** Hawkin Ambler Dilator, conical, 170mm, 13/16mm  
**61600-17** Hawkin Ambler Dilator, conical, 170mm, 14/17mm  
**61600-18** Hawkin Ambler Dilator, conical, 170mm, 15/18mm  
**61600-19** Hawkin Ambler Dilator, conical, 170mm, 16/19mm  
**61600-20** Hawkin Ambler Dilator, conical, 170mm, 17/20mm  
**61600-21** Hawkin Ambler Dilator, conical, 170mm, 18/21mm  
**61600-90** Hawkin Ambler Dilator, conical, 170mm, set of 12 sizes (3/6mm - 14/17mm)



- 61610-02** Hegar Dilator, s/s, double ended, 220mm, 1/2mm  
**61610-04** Hegar Dilator, s/s, double ended, 220mm, 3/4mm  
**61610-06** Hegar Dilator, s/s, double ended, 220mm, 5/6mm  
**61610-08** Hegar Dilator, s/s, double ended, 220mm, 7/8mm  
**61610-10** Hegar Dilator, s/s, double ended, 220mm, 9/10mm  
**61610-12** Hegar Dilator, s/s, double ended, 220mm, 11/12mm  
**61610-14** Hegar Dilator, s/s, double ended, 220mm, 13/14mm  
**61610-16** Hegar Dilator, s/s, double ended, 220mm, 15/16mm  
**61610-18** Hegar Dilator, s/s, double ended, 220mm, 17/18mm  
**61610-20** Hegar Dilator, s/s, double ended, 220mm, 19/20mm  
**61610-22** Hegar Dilator, s/s, double ended, 220mm, 21/22mm  
**61610-24** Hegar Dilator, s/s, double ended, 220mm, 23/24mm  
**61610-26** Hegar Dilator, s/s, double ended, 220mm, 25/26mm  
**61610-90** Hegar Dilator, s/s, double ended, 220mm, set of 8 sizes (3/4mm - 17/18mm)  
**61610-95** Hegar Dilator, s/s, double ended, 220mm, set of 12 sizes (1/2mm - 23/24mm)

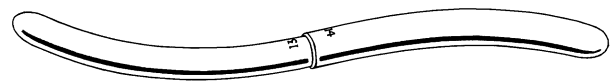

- 61630-10** Umbilical Dilator, 95mm



# Gynaecology and Obstetrics

## Dressing Forceps

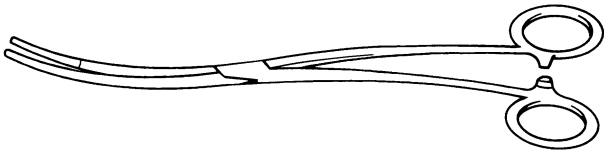

**61700-26** Bozemann Uterine Dressing Forcep, grooved jaw, 265mm

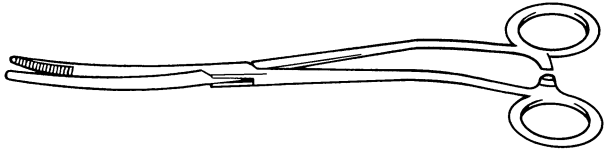

**61710-26** Bozemann Uterine Dressing Forcep, serrated jaw, 265mm

## Introducers

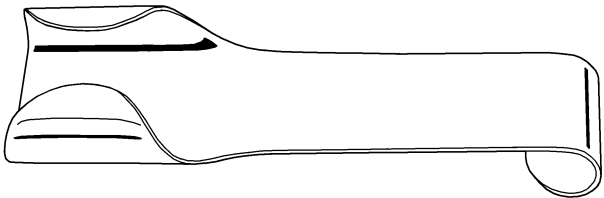

**61850-13** Pessary Introducer, for rubber ring pessary, 135mm

## Myoma Screws

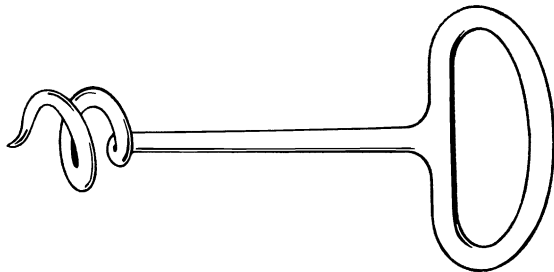

**61900-15** Doyen Myoma Screw, s/s, for abdominal use, 150mm

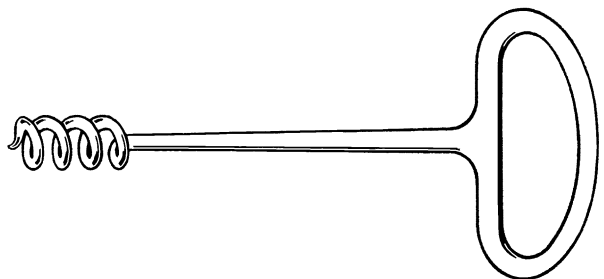

**61910-17** Doyen Myoma Screw, s/s, or vaginal use, 175mm

**62000-41** Barnes Obstetric Forcep, 410mm

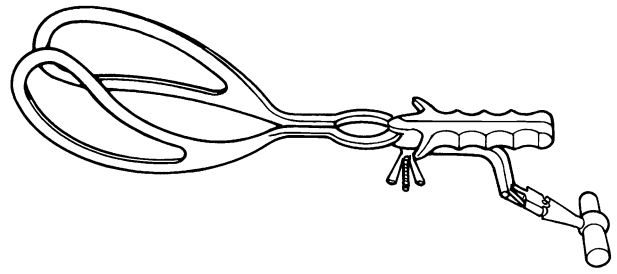

**62020-41** Kielland Obstetric Forcep, 410mm

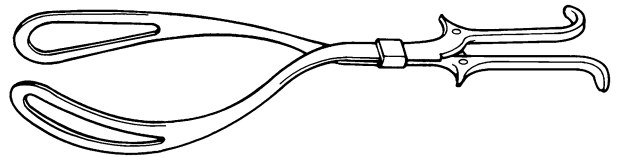

**62030-28** Simpson Obstetric Forcep, short model, 280mm

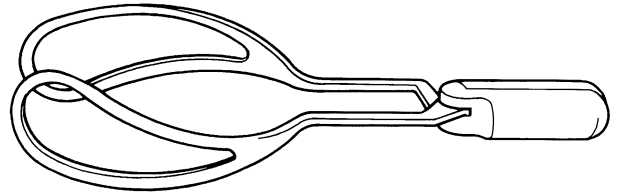

**62040-28** Wrigley Obstetric Forcep, short model, 250mm

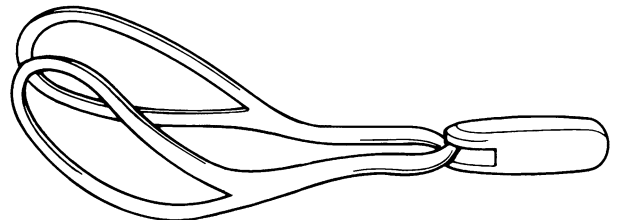

## Ovum Forceps

**62110-24** McClintock Ovum Forcep, curved, screw joint, 240mm

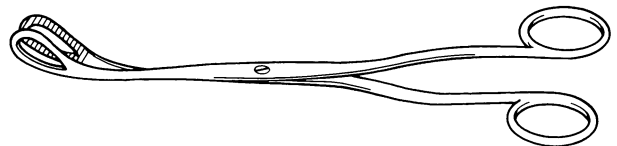

# Gynaecology and Obstetrics

## Peritoneum Forceps

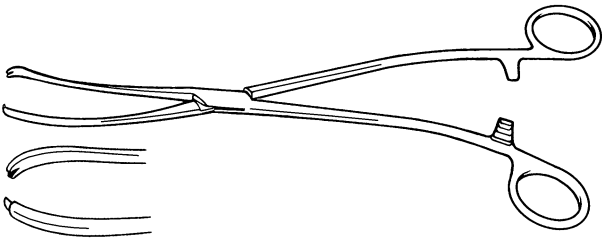

**62400-25** Goodwin Amnietomy Peritoneum Forcep, double curve, 250mm

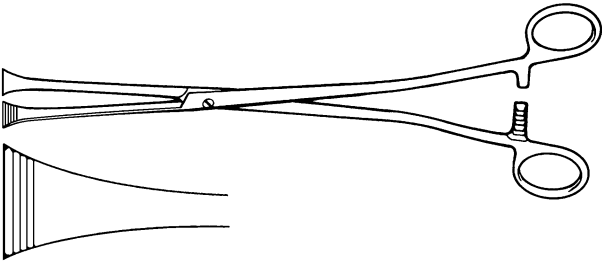

**62420-20** Green Armytage Peritoneum Forcep, straight, screw joint, 210mm

## Probes



**62500-11** Anel Silver Probe, with eye, 110mm

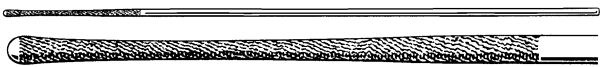

**62510-30** Playfair Probe, 300mm

## Punch Forceps

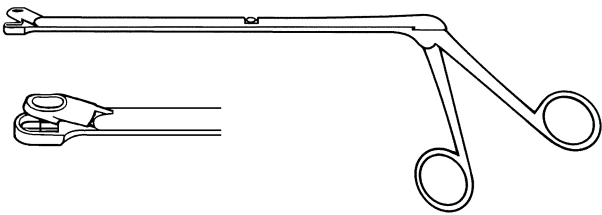

**62600-20** Eppendorf Biopsy Punch Forcep, 200mm effective length

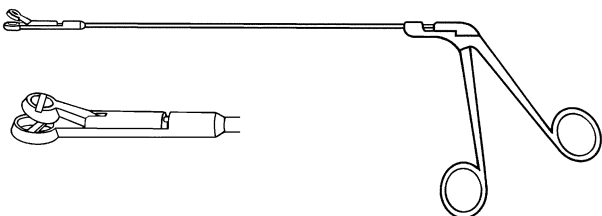

**62610-20** Leech Wilkinson Biopsy Punch Forcep, 200mm effective length

## Punch Forceps

**62620-23** Wittner Cervical Biopsy Punch Forcep, curved to side, 230mm effective length

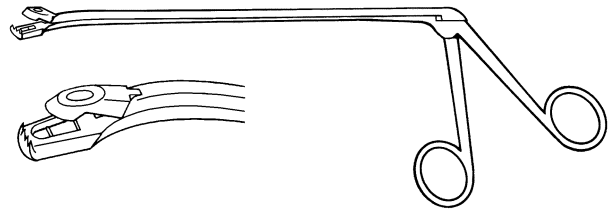

## Retractors

**62700-06** Doyen (Pozzi) Retractor, small, 48mm x 60mm

**62700-09** Doyen (Pozzi) Retractor, medium, 48mm x 90mm

**62700-12** Doyen (Pozzi) Retractor, large, 48mm x 124mm

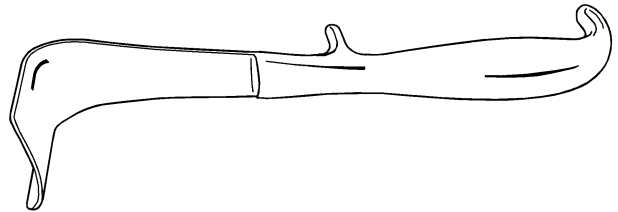

**62710-10** Doyen Retractor, 100mm x 30mm blade

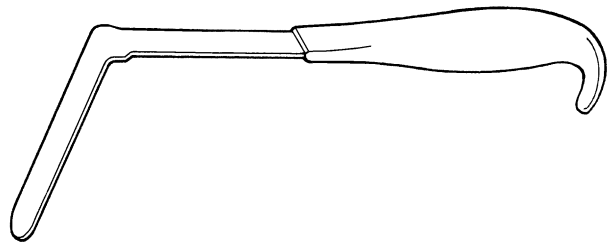

**62720-09** Landon Vaginal Retractor, s/s, 90mm, 25mm blade

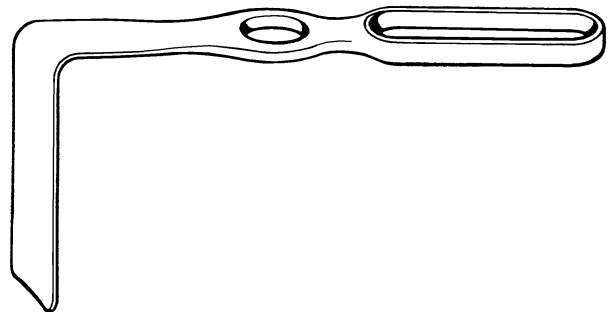

**62730-09** Wertheim Vaginal Retractor, 95mm x 38mm blade

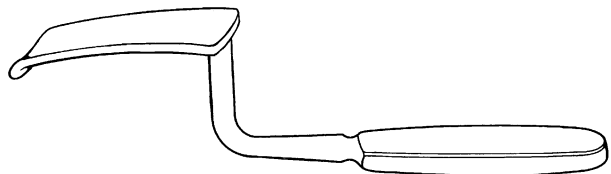

## Scissors

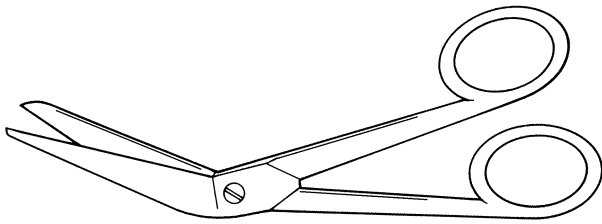

**62900-12** Barnes Episiotomy Scissor, 125mm

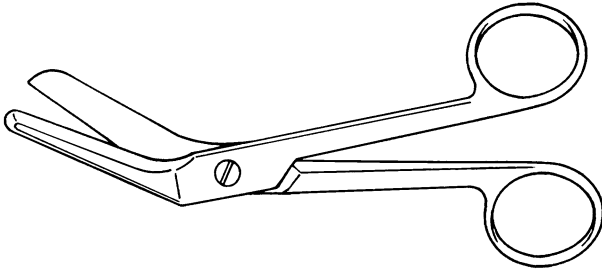

**62910-14** Braun-Stadler Episiotomy Scissor, 140mm

**62910-20** Braun-Stadler Episiotomy Scissor, 200mm

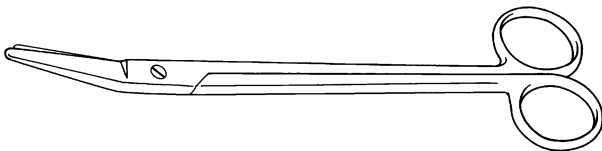

**62915-22** Monaghan Scissor, angled on flat, heavy, 220mm

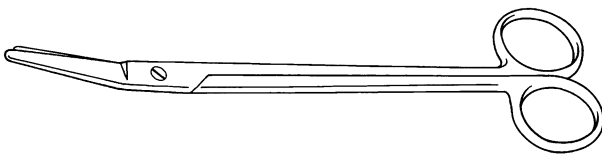

**62916-21** Monaghan Scissor, angled on flat, light, 210mm

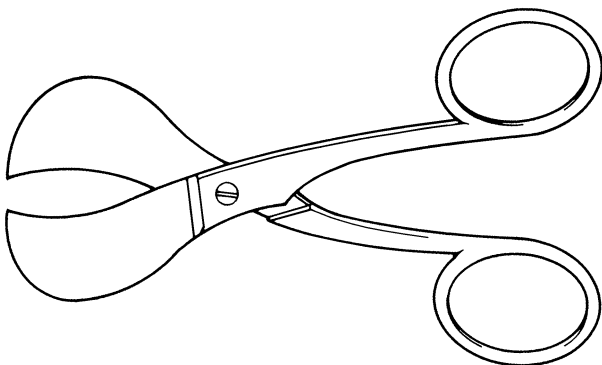

**62920-10** Umbilical Scissor, american pattern, 100mm

## Scissors

**62930-23** Uterine Scissor, angled, 230mm

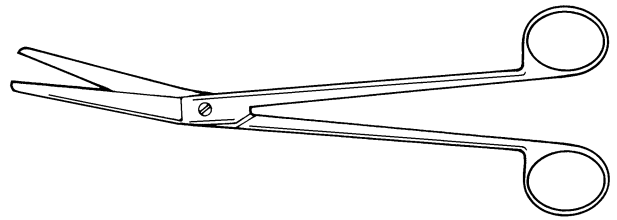

**62940-23** Uterine Scissor, curved, 230mm

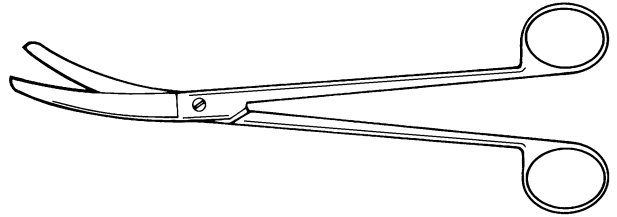

**62950-23** Uterine Scissor, straight, 230mm

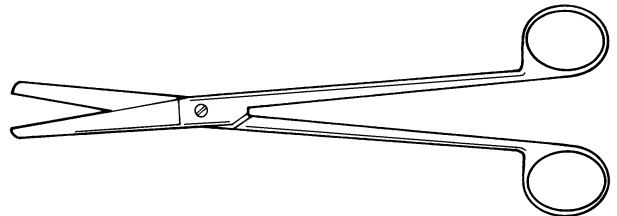

**62960-24** Vant Episiotomy Scissor, 240mm

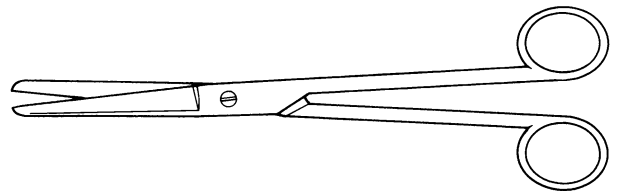

## Sounds

**63000-29** Galabin Uterine Sound, s/p, malleable, shaft graduated in 2 cms, 300mm



**63010-30** Horrocks Uterine Sound, s/p, malleable, shaft graduated in 2 cms, 300mm



**63020-32** Simpson Uterine Sound, s/p, rigid, shaft graduated in 2 cms, 300mm

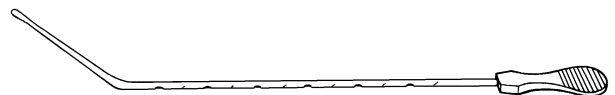

# Gynaecology and Obstetrics

## Suction Tubes

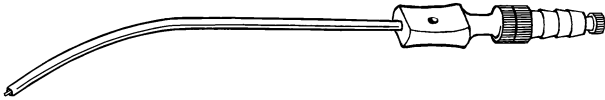

**63200-17** Gillies Suction Tube, s/s, with stilette, 175mm

## Uterine Forceps

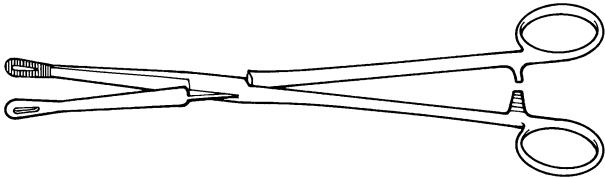

**63300-24** Bonney Polypus Uterine Forcep, oval, 240mm

## Vaginal Specula

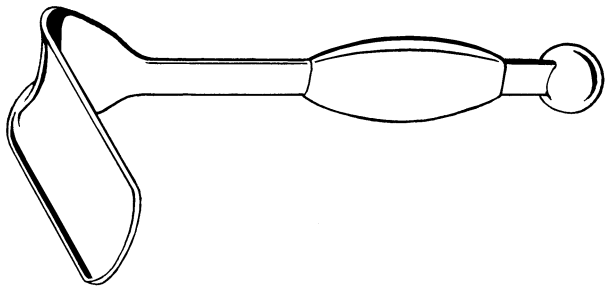

**63414-50** Bailey Vaginal Speculum, fixed weight, 50mm x 40mm blade

**63414-75** Bailey Vaginal Speculum, fixed weight, 75mm x 40mm blade

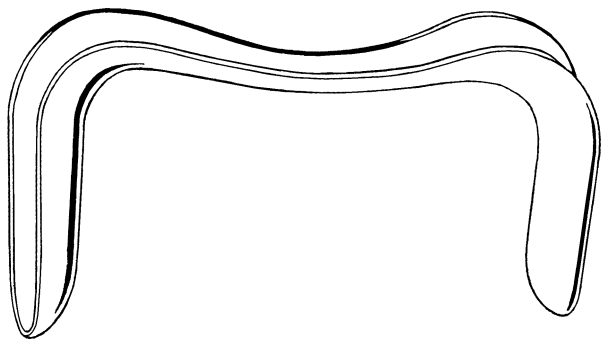

**63450-60** Sims Vaginal Speculum, double ended, small, 60mm x 25mm & 65mm x 30mm

**63450-70** Sims Vaginal Speculum, double ended, medium, 70mm x 30mm & 75mm x 35mm

**63450-80** Sims Vaginal Speculum, double ended, large, 80mm x 35mm & 85mm x 40mm

**63450-90** Sims Vaginal Speculum, double ended, set of 3

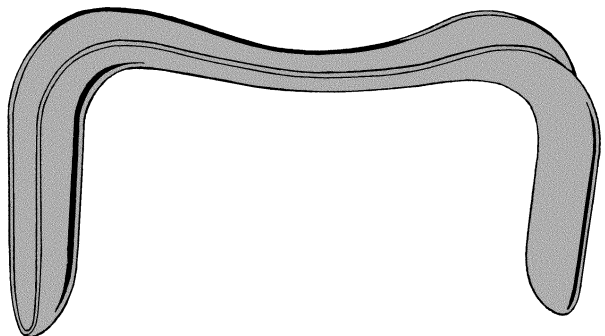

**63451-60** Sims Vaginal Speculum, insulated, double ended, small, 60mm x 25mm & 65mm x 30mm

**63451-70** Sims Vaginal Speculum, insulated, double ended, medium, 70mm x 30mm & 75mm x 35mm

**63451-80** Sims Vaginal Speculum, insulated, double ended, large, 80mm x 35mm & 85mm x 40mm

**63451-90** Sims Vaginal Speculum, insulated, double ended, set of 3



**63500-23** Lower Vulsellum Forcep, 2/2 teeth, 230mm

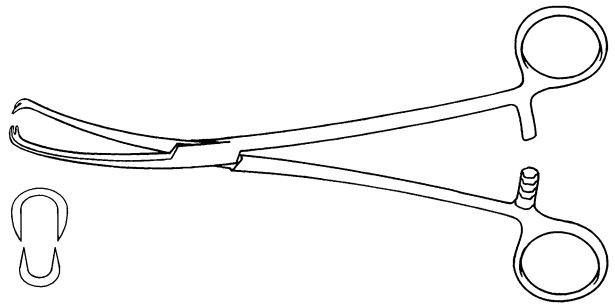

**63510-23** Luer Vulsellum Forcep, 1/1 teeth, 230mm

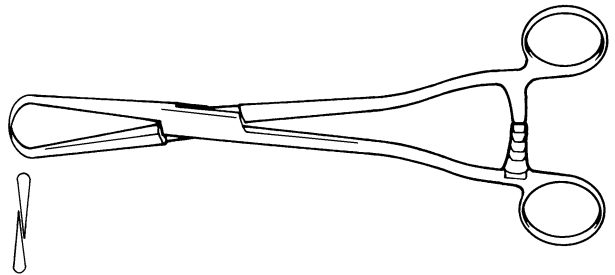

**63515-22** Schroeder Uterine Vulsellum Forcep, 1/1 teeth, 225mm

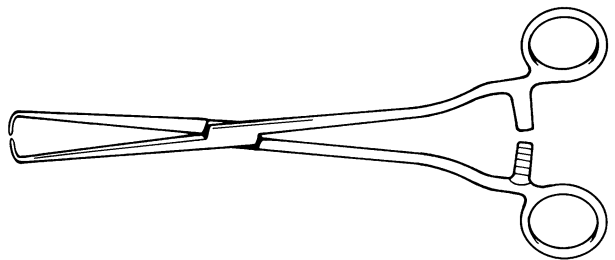

**63520-18** Teales Uterine Vulsellum Forcep, curved, 3/4 teeth, 180mm

**63520-23** Teales Uterine Vulsellum Forcep, curved, 3/4 teeth, 230mm

**63530-23** Teales Uterine Vulsellum Forcep, straight, 3/4 teeth, 230mm

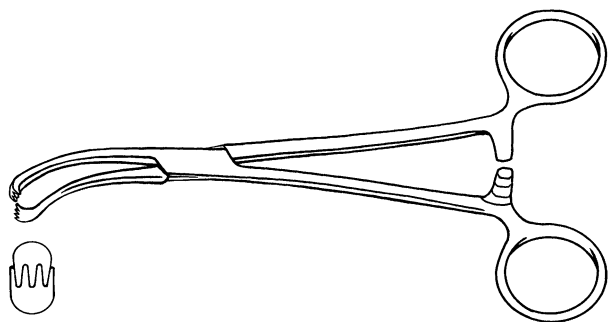

# Neurology

## Artery Forceps

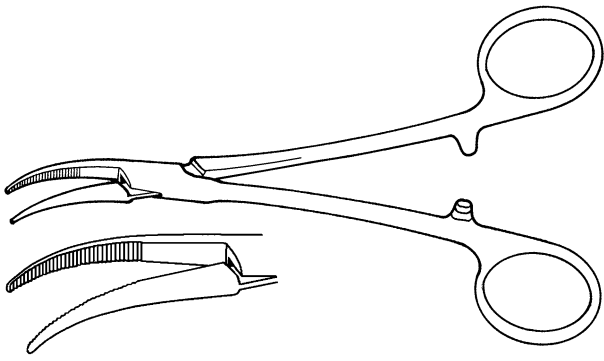

**71000-14** Cairns Artery Forcep, curved to side, half serrated jaws, 145mm

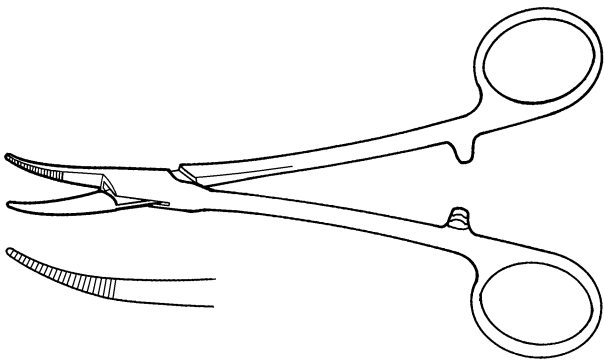

**71010-14** Cairns Artery Forcep, curved, half serrated jaws, 145mm

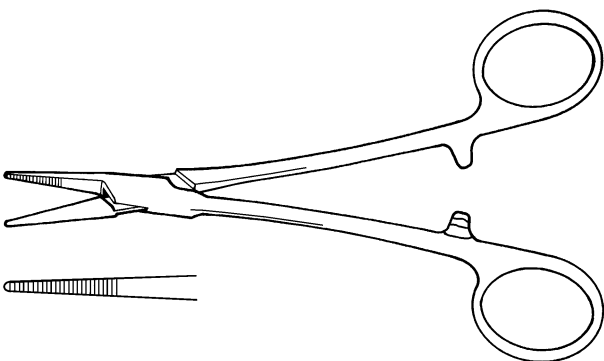

**71020-14** Cairns Artery Forcep, straight, half serrated jaws, 145mm

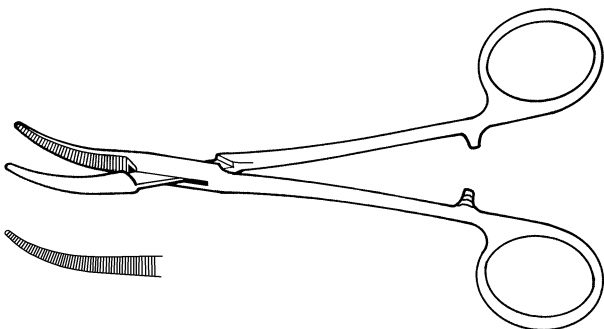

**71030-14** Crile Artery Forcep, curved, serrated jaws, 140mm  
**71030-16** Crile Artery Forcep, curved, serrated jaws, 160mm  
**71030-18** Crile Artery Forcep, curved, serrated jaws, 180mm

- 71040-14** Crile Artery Forcep, straight, serrated jaws, 140mm
- 71040-16** Crile Artery Forcep, straight, serrated jaws, 160mm
- 71040-18** Crile Artery Forcep, straight, serrated jaws, 180mm

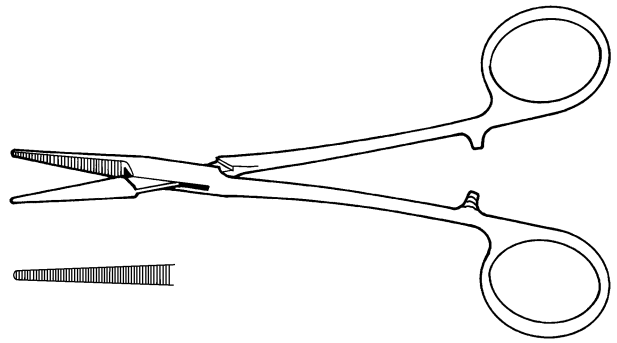

- 71050-14** Cushing Artery Forcep, curved to side, fine half serrated jaws, 145mm

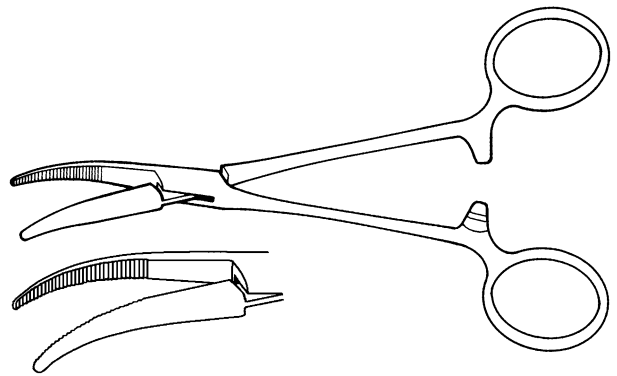

- 71060-14** Cushing Artery Forcep, curved, fine half serrated jaws, 145mm

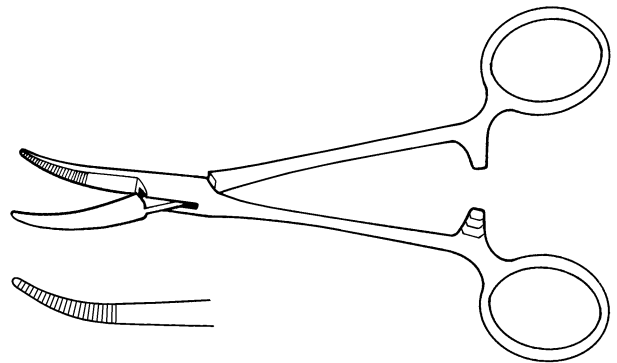

- 71070-14** Cushing Artery Forcep, straight, fine half serrated jaws, 145mm

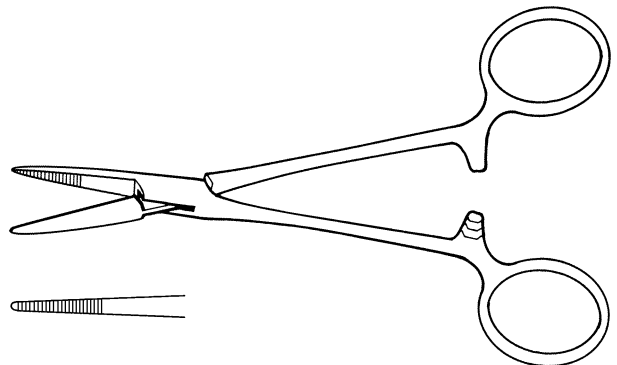

# Neurology

## Braces

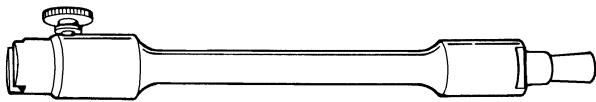

**71100-10** Hudson Brace, extension piece, 100mm

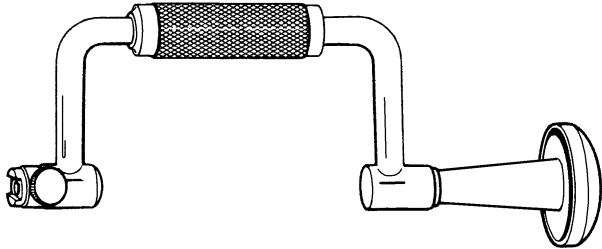

**71110-21** Hudson Brace, universal fitting, small size, 215mm  
**71110-25** Hudson Brace, universal fitting, standard size, 255mm

## Burs



**71200-09** Hudson Conical Bur, 9mm  
**71200-11** Hudson Conical Bur, 11mm  
**71200-13** Hudson Conical Bur, 13mm  
**71200-16** Hudson Conical Bur, 16mm  
**71200-19** Hudson Conical Bur, 19mm



**71210-08** Hudson Perforator, 8mm  
**71210-10** Hudson Perforator, 10mm  
**71210-12** Hudson Perforator, 12mm  
**71210-15** Hudson Perforator, 15mm

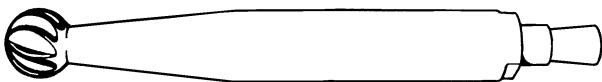

**71220-11** Hudson Spherical Bur, 11mm  
**71220-13** Hudson Spherical Bur, 13mm  
**71220-16** Hudson Spherical Bur, 16mm  
**71220-19** Hudson Spherical Bur, 19mm  
**71220-22** Hudson Spherical Bur, 22mm

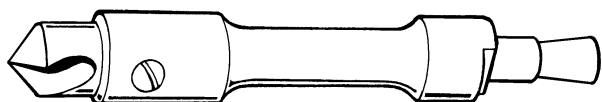

**71230-12** Spiral Undercut Bur, 100mm, 12mm

## Cannulae

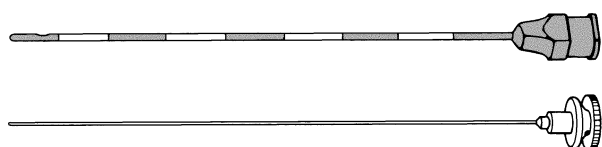

**71300-14** Cone Ventricular Cannula, graduated in cms, luer fitting, 2.03mm diameter (14 swg)  
**71300-16** Cone Ventricular Cannula, graduated in cms, luer fitting, 1.63mm diameter (16 swg)  
**71300-18** Cone Ventricular Cannula, graduated in cms, luer fitting, 1.22mm diameter (18 swg)

## Cannulae

- 71310-06** Jefferson Ventricular Cannula, graduated in cms, luer fitting, 60mm
- 71310-08** Jefferson Ventricular Cannula, graduated in cms, luer fitting, 80mm
- 71310-10** Jefferson Ventricular Cannula, graduated in cms, luer fitting, 100mm

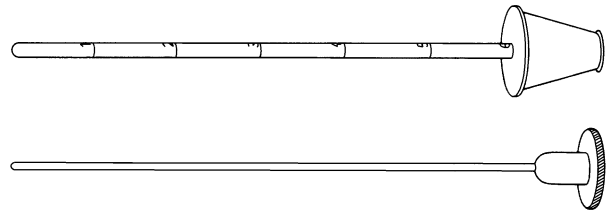

## Clip Forceps

- 71400-14** McKenzie Clip Forcep, curved, applying, 140mm
- 71400-17** McKenzie Clip Forcep, curved, applying, 175mm

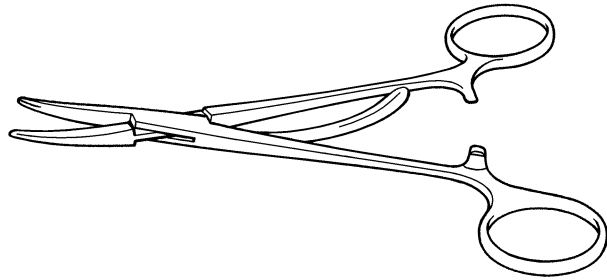

- 71430-16** Raney Clip Forcep, applying, 160mm

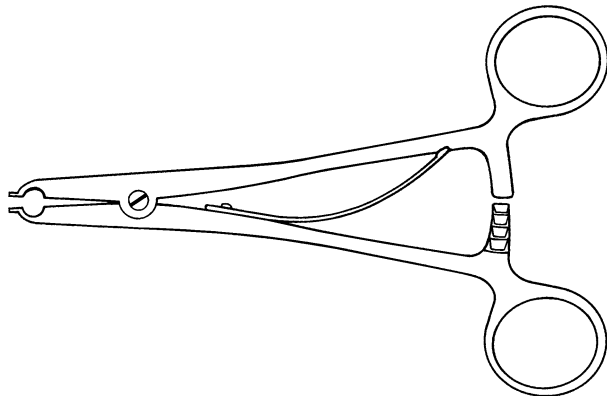

## Curettes

- 71500-20** American Spinal Curette, straight, tufnol handle, 255mm, size 000, 2.0mm x 4mm
- 71500-25** American Spinal Curette, straight, tufnol handle, 255mm, size 00, 2.5mm x 4.5mm
- 71500-27** American Spinal Curette, straight, tufnol handle, 255mm, size 0, 2.75mm x 5mm
- 71500-30** American Spinal Curette, straight, tufnol handle, 255mm, size 1, 3.0mm x 5.5mm
- 71500-32** American Spinal Curette, straight, tufnol handle, 255mm, size 2, 3.25mm x 6mm
- 71500-40** American Spinal Curette, straight, tufnol handle, 255mm, size 3, 4.0mm x 7mm
- 71500-60** American Spinal Curette, straight, tufnol handle, 255mm, size 4, 6.0mm x 9.5mm
- 71500-70** American Spinal Curette, straight, tufnol handle, 255mm, size 5, 7.0mm x 14mm
- 71500-90** American Spinal Curette, straight, tufnol handle, 255mm, size 6, 9.0mm x 17mm

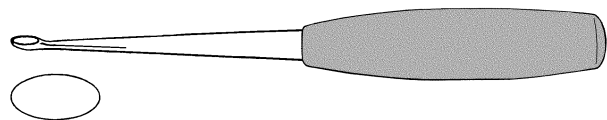

# Neurology

## Curettes

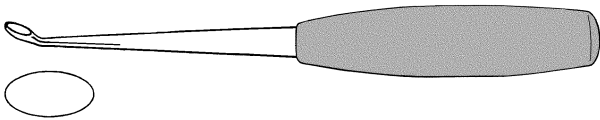

- 71501-20** American Spinal Curette, angled, tufnol handle, 255mm, size 000, 2.0mm x 4mm
- 71501-25** American Spinal Curette, angled, tufnol handle, 255mm, size 00, 2.5mm x 4.5mm
- 71501-27** American Spinal Curette, angled, tufnol handle, 255mm, size 0, 2.75mm x 5mm
- 71501-30** American Spinal Curette, angled, tufnol handle, 255mm, size 1, 3.0mm x 5.5mm
- 71501-32** American Spinal Curette, angled, tufnol handle, 255mm, size 2, 3.25mm x 6mm
- 71501-40** American Spinal Curette, angled, tufnol handle, 255mm, size 3, 4.0mm x 7mm
- 71501-60** American Spinal Curette, angled, tufnol handle, 255mm, size 4, 6.0mm x 9.5mm
- 71501-70** American Spinal Curette, angled, tufnol handle, 255mm, size 5, 7.0mm x 14mm
- 71501-90** American Spinal Curette, angled, tufnol handle, 255mm, size 6, 9.0mm x 17mm

## Dissecting Forceps



- 71600-19** Adson Bayonet Dissecting Forcep, 1/2 teeth, 190mm



- 71610-19** Adson Bayonet Dissecting Forcep, serrated, fine, 190mm



- 71630-16** Cairns Dissecting Forcep, delicate, 2/3 teeth, 165mm

- 71630-21** Cairns Dissecting Forcep, delicate, 2/3 teeth, 215mm



- 71640-17** Dott Dissecting Forcep, fine, 1/2 teeth, 175mm

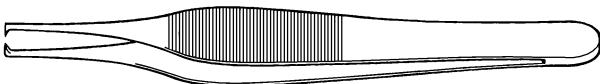

- 71650-18** Jefferson Dissecting Forcep, fine, 1/2 teeth, 175mm



- 71660-16** Pennybacker Dissecting Forcep, 3/4 teeth, 165mm

## Dissectors

**71710-22** Pennybacker Dissector, double ended, 225mm



**71720-17** Swedish Dissector, double ended, 175mm

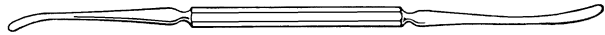

## Dressing Forceps

**71800-18** Cairns Dressing Forcep, fine, serrated jaws, 180mm



**71810-21** Cairns Dressing Forcep, medium, serrated jaws, 215mm



**71820-18** Jefferson Dressing Forcep, serrated jaws, 180mm

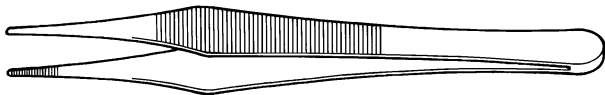

## Dural Hooks

**72000-19** Adson Dural Hook, rectangular, blunt, 190mm

**72010-19** Adson Dural Hook, rectangular, sharp, 190mm

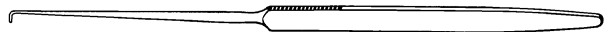

**72020-12** Cairns Dural Hook, fine, sharp, 125mm

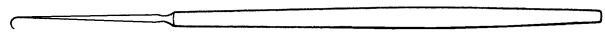

**72030-12** Cairns Dural Hook, sharp, 125mm



**72040-25** Nerve Dural Hook, 250mm



**72055-30** Smithwick Sympathectomy Hook, double ended, 305mm

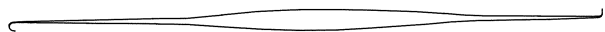

# Neurology

## Elevators



- 72100-05** Adson Periosteal Elevator, curved, 165mm, 5mm wide
- 72100-07** Adson Periosteal Elevator, curved, 165mm, 7mm wide

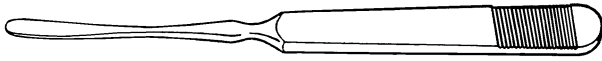

- 72110-05** Adson Periosteal Elevator, straight, 165mm, 5mm wide
- 72110-07** Adson Periosteal Elevator, straight, 165mm, 7mm wide

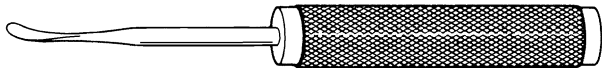

- 72119-13** Cobb Elevator, 375mm overall length, 245mm handle, 13mm
- 72119-16** Cobb Elevator, 375mm overall length, 245mm handle, 16mm
- 72119-20** Cobb Elevator, 375mm overall length, 245mm handle, 20mm
- 72120-10** Cobb Elevator, 275mm overall length, 145mm handle, 10mm
- 72120-13** Cobb Elevator, 275mm overall length, 145mm handle, 13mm
- 72120-19** Cobb Elevator, 275mm overall length, 145mm handle, 19mm

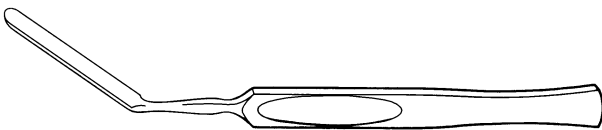

- 72124-18** Horsley Dura Mater Elevator, single ended, 180mm



- 72126-10** Horsley Dura Mater Elevator, double ended

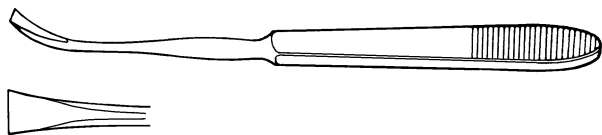

- 72130-04** Pennybacker Elevator, curved, sharp, 150mm, 4mm wide
- 72130-06** Pennybacker Elevator, curved, sharp, 150mm, 6mm wide
- 72130-08** Pennybacker Elevator, curved, sharp, 150mm, 8mm wide





- 72200-06** Capener Gouge, cranked, for lamina, tufnol handle, length 235mm, 6mm
- 72200-08** Capener Gouge, cranked, for lamina, tufnol handle, length 235mm, 8mm
- 72200-10** Capener Gouge, cranked, for lamina, tufnol handle, length 235mm, 10mm
- 72200-11** Capener Gouge, cranked, for lamina, tufnol handle, length 235mm, 11mm
- 72200-13** Capener Gouge, cranked, for lamina, tufnol handle, length 235mm, 13mm
- 72200-16** Capener Gouge, cranked, for lamina, tufnol handle, length 235mm, 16mm
- 72200-19** Capener Gouge, cranked, for lamina, tufnol handle, length 235mm, 19mm
- 72200-25** Capener Gouge, cranked, for lamina, tufnol handle, length 235mm, 25mm

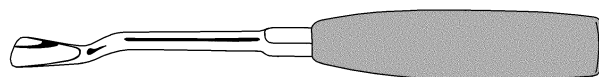

- 72210-06** Capener Gouge, cranked, reverse blade, tufnol handle, length 235mm, 6mm
- 72210-13** Capener Gouge, cranked, reverse blade, tufnol handle, length 235mm, 13mm
- 72210-19** Capener Gouge, cranked, reverse blade, tufnol handle, length 235mm, 19mm
- 72210-25** Capener Gouge, cranked, reverse blade, tufnol handle, length 235mm, 25mm
- 72210-32** Capener Gouge, cranked, reverse blade, tufnol handle, length 235mm, 32mm

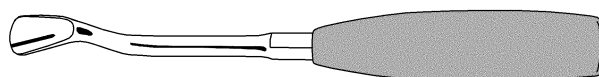

- 72220-06** Capener Gouge, straight, tufnol handle, 250mm, 6mm
- 72220-08** Capener Gouge, straight, tufnol handle, 250mm, 8mm
- 72220-10** Capener Gouge, straight, tufnol handle, 250mm, 10mm
- 72220-11** Capener Gouge, straight, tufnol handle, 250mm, 11mm
- 72220-13** Capener Gouge, straight, tufnol handle, 250mm, 13mm
- 72220-15** Capener Gouge, straight, tufnol handle, 250mm, 15mm
- 72220-16** Capener Gouge, straight, tufnol handle, 250mm, 16mm
- 72220-19** Capener Gouge, straight, tufnol handle, 250mm, 19mm
- 72220-20** Capener Gouge, straight, tufnol handle, 250mm, 20mm
- 72220-25** Capener Gouge, straight, tufnol handle, 250mm, 25mm
- 72220-30** Capener Gouge, straight, tufnol handle, 250mm, 30mm

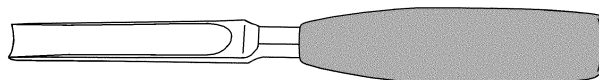

- 72300-12** Cairns Dural Guide And Director, 125mm

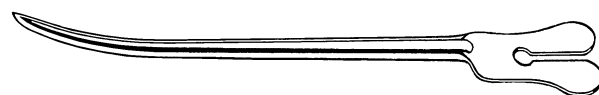

# Neurology

## Needleholders - Tungsten Carbide

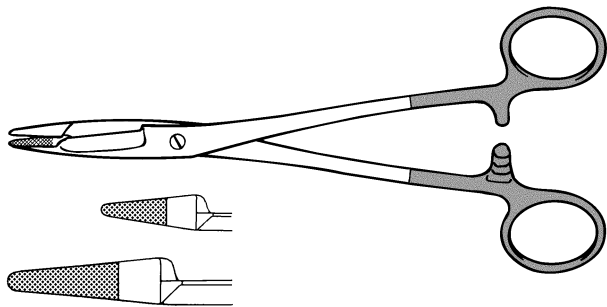

- 72600-14** Olsen-Hegar Needleholder, tungsten carbide, 140mm
- 72600-19** Olsen-Hegar Needleholder, tungsten carbide, 190mm

## Retractors

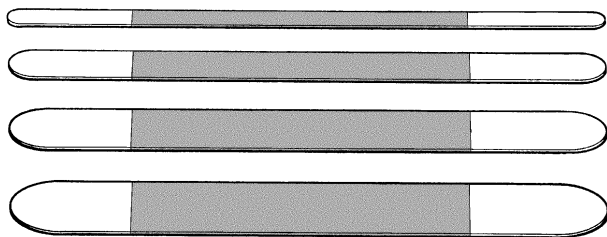

- 73100-06** Cairns Strip Retractor, 200mm x 6mm
- 73100-08** Cairns Strip Retractor, 200mm x 8mm
- 73100-09** Cairns Strip Retractor, 200mm x 9mm
- 73100-10** Cairns Strip Retractor, 200mm x 10mm
- 73100-11** Cairns Strip Retractor, 200mm x 11mm
- 73100-13** Cairns Strip Retractor, 200mm x 13mm
- 73100-16** Cairns Strip Retractor, 200mm x 16mm
- 73100-19** Cairns Strip Retractor, 200mm x 19mm
- 73100-22** Cairns Strip Retractor, 200mm x 22mm
- 73100-25** Cairns Strip Retractor, 200mm x 25mm

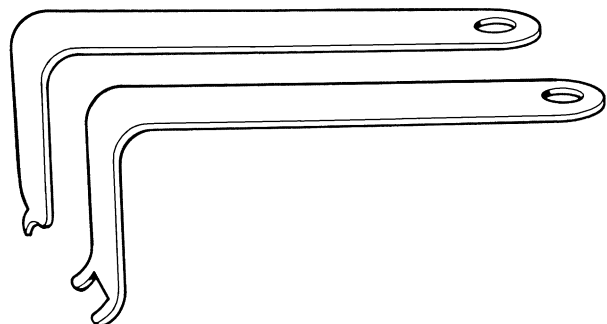

- 73110-10** Charnley Laminectomy Retractor, sharp blade only, large, 185mm, 70mm deep
- 73110-20** Charnley Laminectomy Retractor, blunt blade only, large, 185mm, 70mm deep
- 73110-30** Charnley Laminectomy Retractor, sharp blade only, small, 185mm, 55mm deep
- 73110-40** Charnley Laminectomy Retractor, blunt blade only, small, 185mm, 55mm deep
- 73110-85** Charnley Laminectomy Retractor, set of 1 sharp and 1 blunt, small, 185mm, 55mm deep, with weight and chain
- 73110-90** Charnley Laminectomy Retractor, set of 1 sharp and 1 blunt, large, 185mm, 70mm deep, with weight and chain
- 73110-95** Charnley Laminectomy Retractor, set of 2 sharp and 2 blunt, small and large, with 2 weight and chain

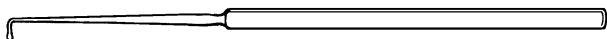

- 73120-19** Cushing Retractor, 190mm
- 73120-22** Cushing Retractor, 225mm
- 73120-28** Cushing Retractor, 280mm



- 73160-10** Hibbs Retractor, 200mm, 10mm x 38mm blade
- 73160-16** Hibbs Retractor, 200mm, 16mm x 54mm blade
- 73160-25** Hibbs Retractor, 200mm, 25mm x 70mm blade

## Retractors

- 73170-10** Love Nerve Root Retractor, angled
- 73180-10** Love Nerve Root Retractor, right angled
- 73190-10** Love Nerve Root Retractor, straight



- 73195-18** Mathieu Retractor, double ended, 180mm

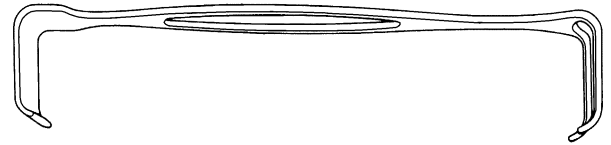

- 73200-21** O'Connell Nerve Root Retractor, double ended, 215mm

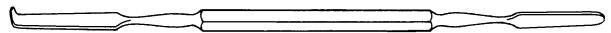

## Retractors - Self Retaining

- 73280-14** Cairns Scalp Self Retaining Retractor, curved, sharp swivel blades, 140mm

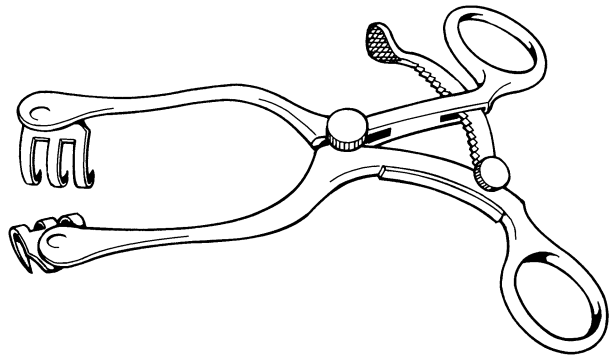

- 73300-24** Cone Laminectomy Self Retaining Retractor, blunt, 3/4 prong, 255mm
- 73310-24** Cone Laminectomy Self Retaining Retractor, sharp, 3/4 prong, 255mm

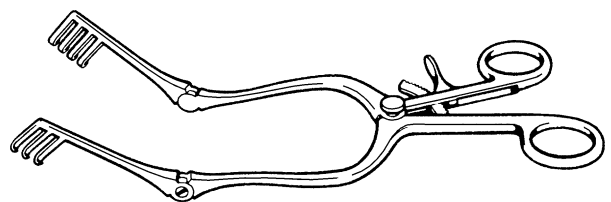

- 73315-10** Hardman Laminectomy Self Retaining Retractor, short prong on left
- 73315-20** Hardman Laminectomy Self Retaining Retractor, short prong on right
- 73315-30** Hardman Laminectomy Self Retaining Retractor, equal long prongs

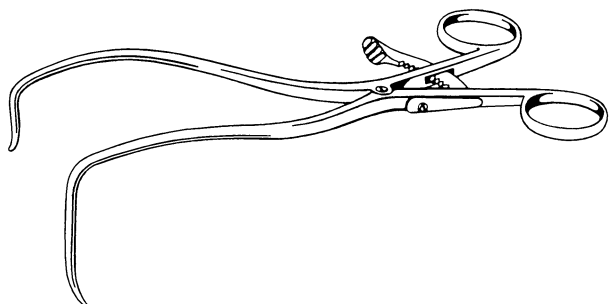

# Neurology

## Retractors - Self Retaining

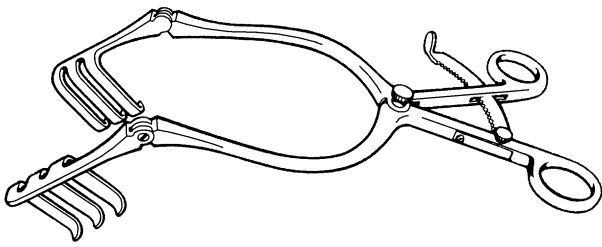

**73330-30** Harvey-Jackson Self Retaining Retractor, hinged arms, 305mm, 38 x 44mm blades

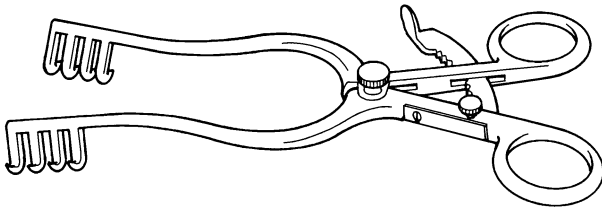

**73350-13** Henderson Self Retaining Retractor, blunt, 135mm

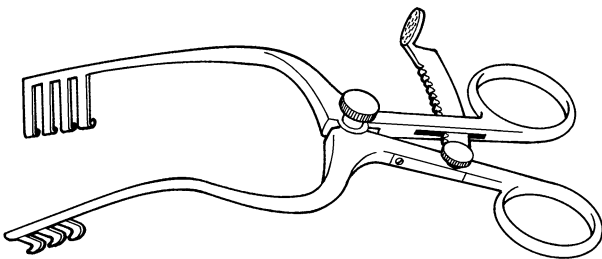

**73360-14** Jefferson Self Retaining Retractor, curved, blunt, 3/4 prong, 140mm

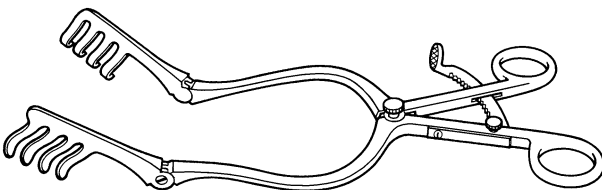

**73370-29** Mayo Adson Self Retaining Retractor, hinged arms, 290mm

**73400-03** Bateman Rongeur, 40 degree upward cutting,  
150mm, 3mm bite

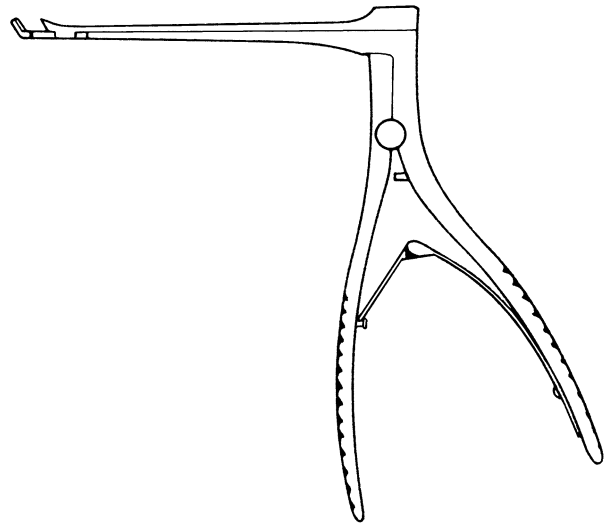

**73420-04** Cushing Pituitary Rongeur, curved with teeth,  
135mm, 4mm bite

**73420-05** Cushing Pituitary Rongeur, curved with teeth,  
135mm, 5mm bite

**73420-06** Cushing Pituitary Rongeur, curved with teeth,  
135mm, 6mm bite

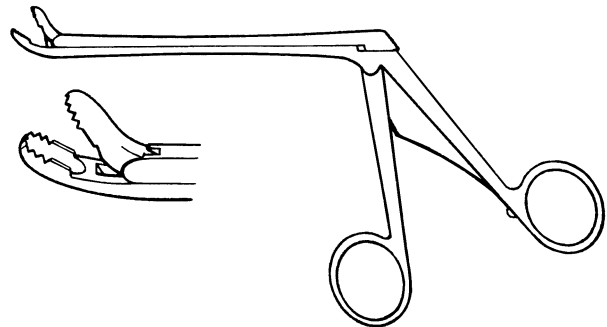

**73430-04** Cushing Pituitary Rongeur, straight with teeth,  
135mm, 4mm bite

**73430-05** Cushing Pituitary Rongeur, straight with teeth,  
135mm, 5mm bite

**73430-06** Cushing Pituitary Rongeur, straight with teeth,  
135mm, 6mm bite

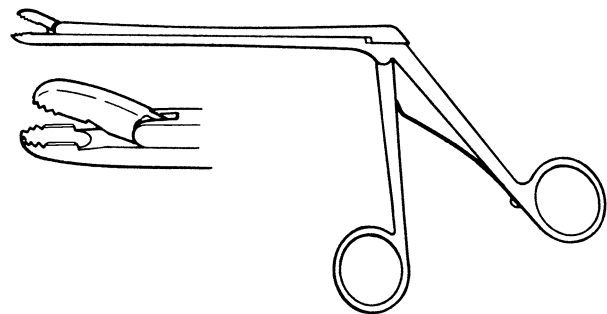

**73440-03** Cushing Rongeur, angled downward, 130mm,  
3mm bite

**73440-04** Cushing Rongeur, angled downward, 130mm,  
4mm bite

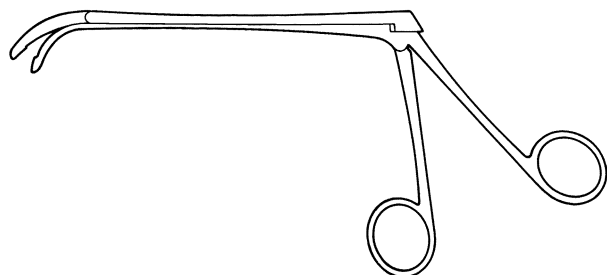

# Neurology

## Rongeurs

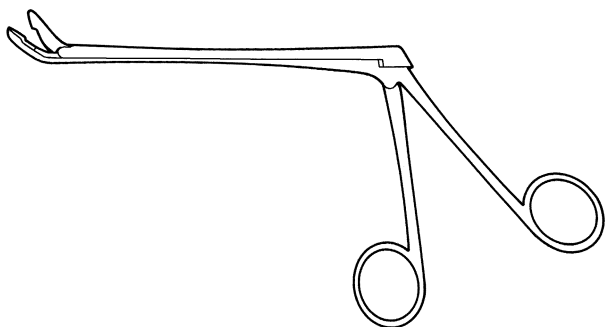

- 73450-03** Cushing Rongeur, angled upward, 130mm, 3mm bite
- 73450-04** Cushing Rongeur, angled upward, 130mm, 4mm bite
- 73450-05** Cushing Rongeur, angled upward, 130mm, 5mm bite

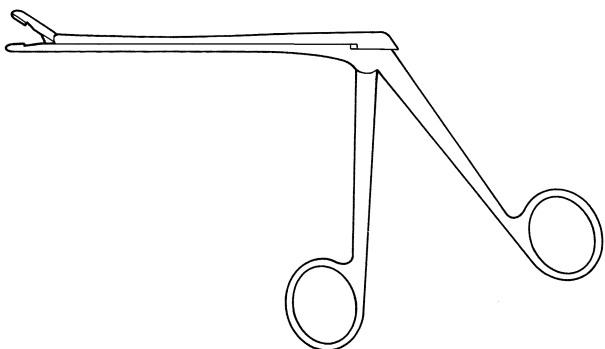

- 73460-04** Cushing Rongeur, straight, 130mm, 4mm bite
- 73460-05** Cushing Rongeur, straight, 130mm, 5mm bite
- 73460-07** Cushing Rongeur, straight, 130mm, 7mm bite

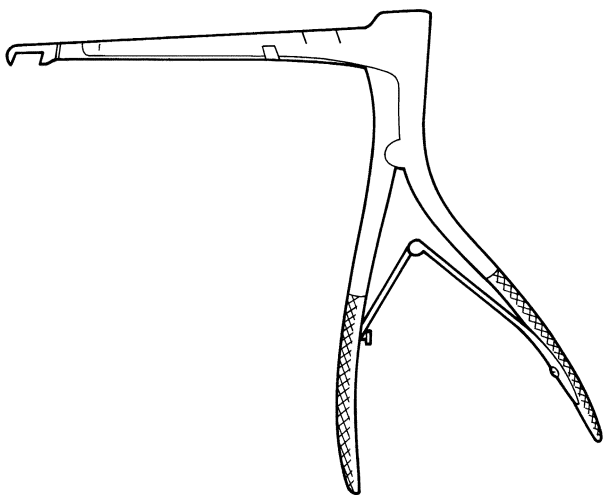

- 73470-03** Falconer Rongeur, downward cutting, 140mm, 3mm bite
- 73470-05** Falconer Rongeur, downward cutting, 140mm, 5mm bite

- 73480-03** Falconer Rongeur, upward cutting, 140mm, 3mm bite  
**73480-05** Falconer Rongeur, upward cutting, 140mm, 5mm bite

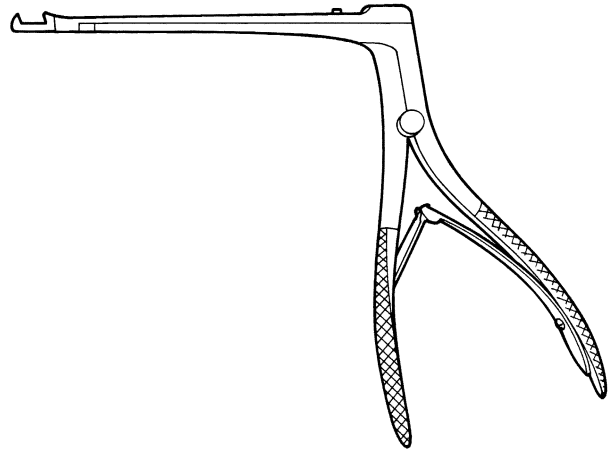

- 73490-04** Glasgow Rongeur, curved on flat, screw joint, 145mm, 4mm bite

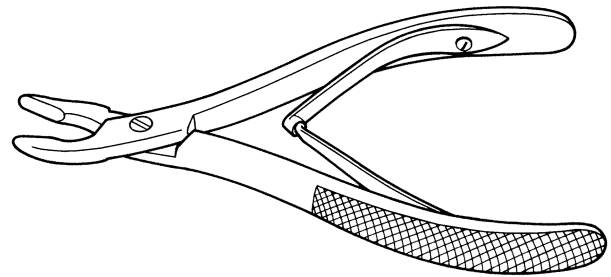

- 73500-08** Jansen Rongeur, small curve, screw joint, 150mm, 8mm bite

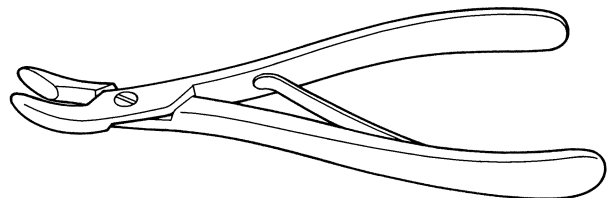

## Rongeurs

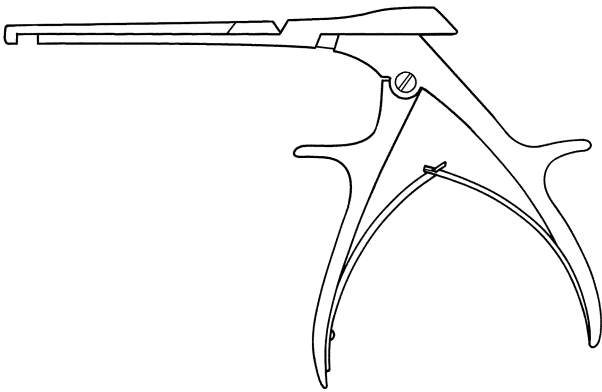

- 73510-03** Kerrison Rongeur, 40 degree downward cutting, 180mm, 3mm bite
- 73510-04** Kerrison Rongeur, 40 degree downward cutting, 180mm, 4mm bite
- 73510-05** Kerrison Rongeur, 40 degree downward cutting, 180mm, 5mm bite
- 73520-03** Kerrison Rongeur, downward cutting, 150mm, 3mm bite
- 73520-04** Kerrison Rongeur, downward cutting, 150mm, 4mm bite
- 73520-05** Kerrison Rongeur, downward cutting, 150mm, 5mm bite
- 73530-02** Kerrison Rongeur, downward cutting, 180mm, 2mm bite
- 73530-03** Kerrison Rongeur, downward cutting, 180mm, 3mm bite
- 73540-03** Kerrison Rongeur, downward cutting, 200mm, 3mm bite
- 73540-04** Kerrison Rongeur, downward cutting, 200mm, 4mm bite
- 73540-05** Kerrison Rongeur, downward cutting, 200mm, 5mm bite

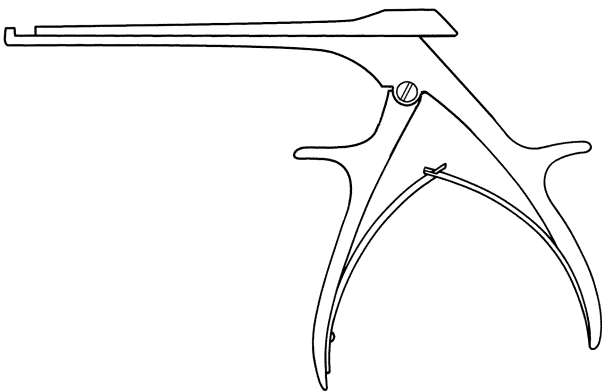

- 73550-03** Kerrison Rongeur, upward cutting, 150mm, 3mm bite
- 73550-04** Kerrison Rongeur, upward cutting, 150mm, 4mm bite
- 73550-05** Kerrison Rongeur, upward cutting, 150mm, 5mm bite
- 73560-02** Kerrison Rongeur, upward cutting, 180mm, 2mm bite
- 73560-03** Kerrison Rongeur, upward cutting, 180mm, 3mm bite
- 73570-03** Kerrison Rongeur, upward cutting, 200mm, 3mm bite
- 73570-04** Kerrison Rongeur, upward cutting, 200mm, 4mm bite
- 73570-05** Kerrison Rongeur, upward cutting, 200mm, 5mm bite

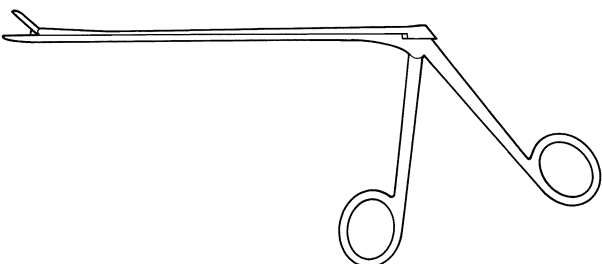

- 73580-03** Love-Grunwald Rongeur, curved downward, 180mm, 3mm bite
- 73590-03** Love-Grunwald Rongeur, curved upward, 180mm, 3mm bite
- 73600-03** Love-Grunwald Rongeur, straight, 180mm, 3mm bite



**73610-04** Northfield Rongeur, curved upward, 130mm, 4mm bite

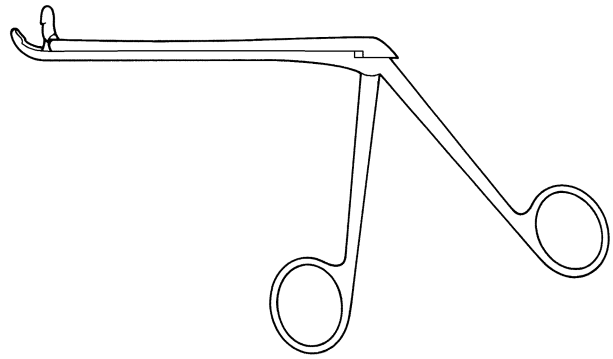

**73620-10** Northfield Rongeur, straight, 200mm, 10mm bite

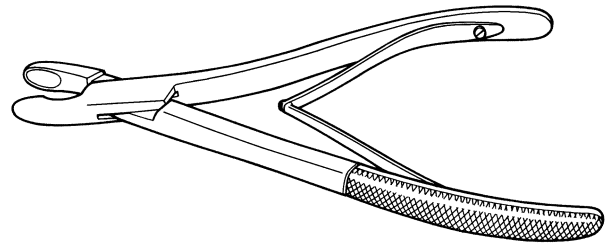

**73630-05** Olivecrona Rongeur, angled to side, 200mm, 5mm bite

**73630-06** Olivecrona Rongeur, angled to side, 230mm, 6mm bite

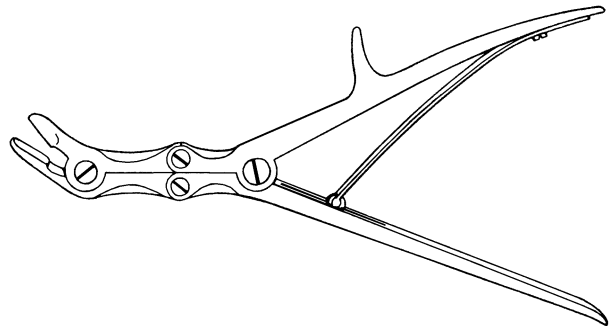

**73640-03** Pennybacker Rongeur, straight, 115mm, 3mm bite

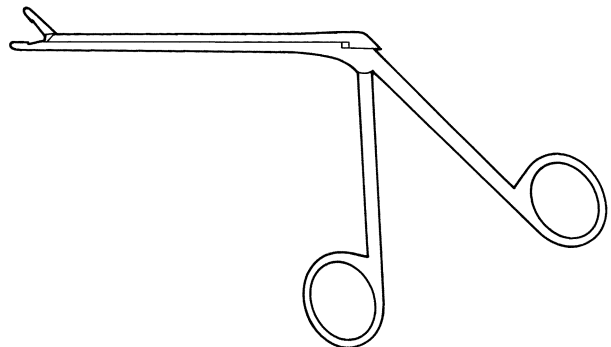

# Neurology

## Rongeurs

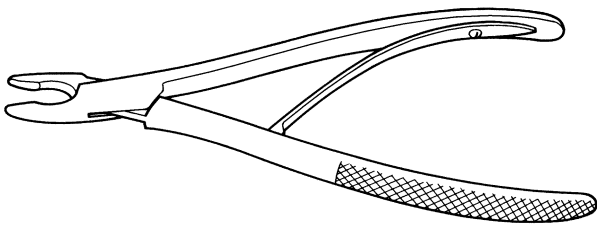

**73650-04** Pennybacker Rongeur, straight, fine jaw, 200mm, 4mm bite

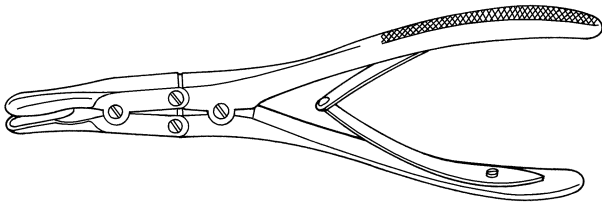

**73660-06** Ruskin Rongeur, curved on flat, compound action, 185mm, 6mm bite

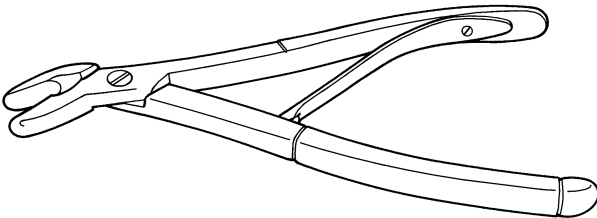

**73670-10** Trotter Rongeur, angled to side, screw joint, 200mm, 10mm bite

## Saws



**73700-30** De Martel Saw Guide, for gigli saw, 305mm

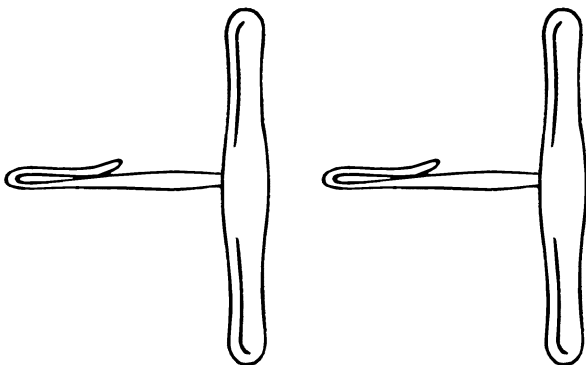

**73710-50** Gigli Saw Handle, pair, 50mm

## Saws

- 73720-30 Gigli Saw, 300mm
- 73720-50 Gigli Saw, 500mm
- 73720-70 Gigli Saw, 700mm

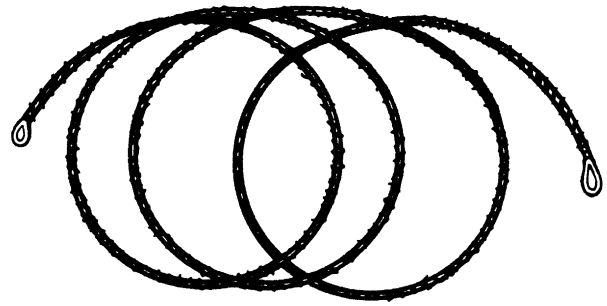

## Scissors

- 73800-17 Cairns Scissor, angled on flat, 175mm

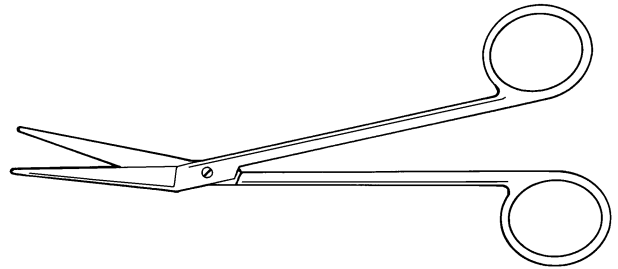

- 73830-14 McKissocks Dural Scissor, curved, 145mm

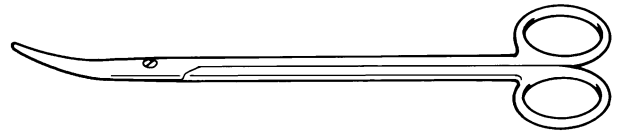

- 73831-14 McKissocks Dural Scissor, straight, 145mm

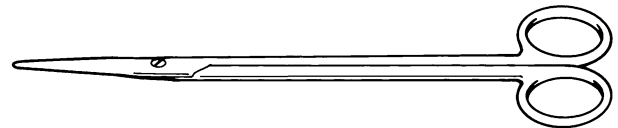

## Shears

- 73900-26 Swedish Laminectomy Shear, compound action, 265mm

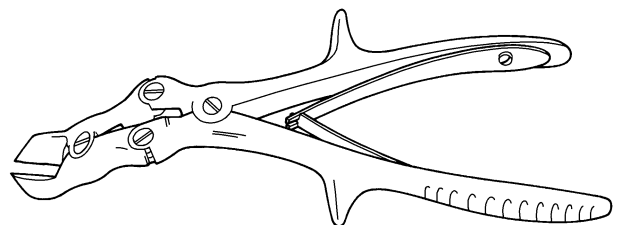

# Neurology

## Suction Tubes

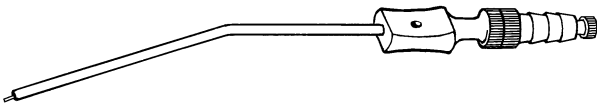

- 74000-07** Adson Frazier Suction Tube, s/s, angled, 175mm, 7FG, 2.3mm
- 74000-08** Adson Frazier Suction Tube, s/s, angled, 175mm, 8FG, 2.7mm
- 74000-09** Adson Frazier Suction Tube, s/s, angled, 175mm, 9FG, 3.0mm

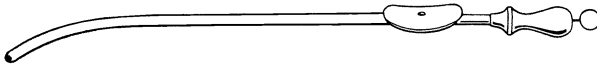

- 74010-15** Adson Suction Tube, s/s, slight curve, 155mm

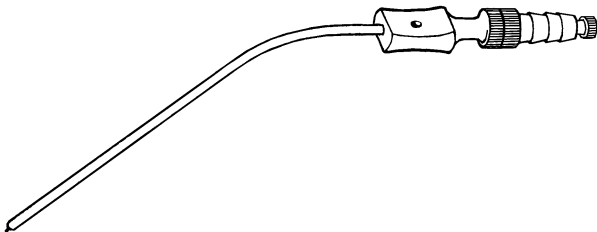

- 74020-05** Frazier Suction Tube, s/s, angled, 180mm, 5FG, 1.7mm
- 74020-06** Frazier Suction Tube, s/s, angled, 180mm, 6FG, 2.0mm
- 74020-07** Frazier Suction Tube, s/s, angled, 180mm, 7FG, 2.3mm
- 74020-08** Frazier Suction Tube, s/s, angled, 180mm, 8FG, 2.7mm
- 74020-09** Frazier Suction Tube, s/s, angled, 180mm, 9FG, 3.0mm
- 74020-10** Frazier Suction Tube, s/s, angled, 180mm, 10FG, 3.3mm
- 74020-11** Frazier Suction Tube, s/s, angled, 180mm, 11FG, 3.7mm
- 74020-12** Frazier Suction Tube, s/s, angled, 180mm, 12FG, 4.0mm

## Traction Apparatus

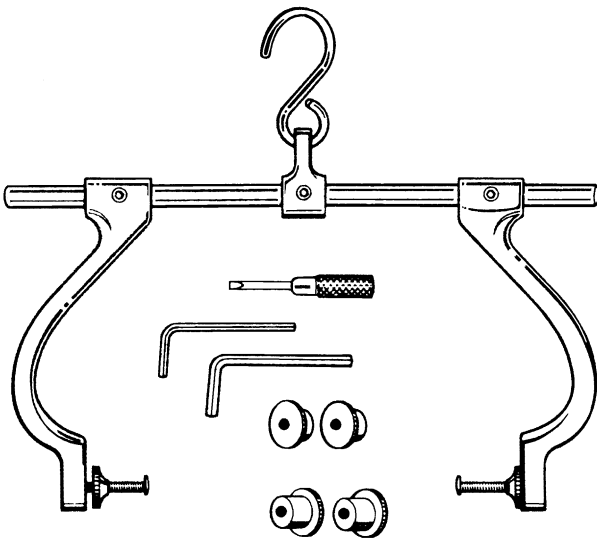

- 74300-90** Blackburn Traction Apparatus, with washers, allen key and screwdrivers

## Traction Tongs

**74400-90** Cones Traction Tong, complete with 2 pairs of pins and a spanner

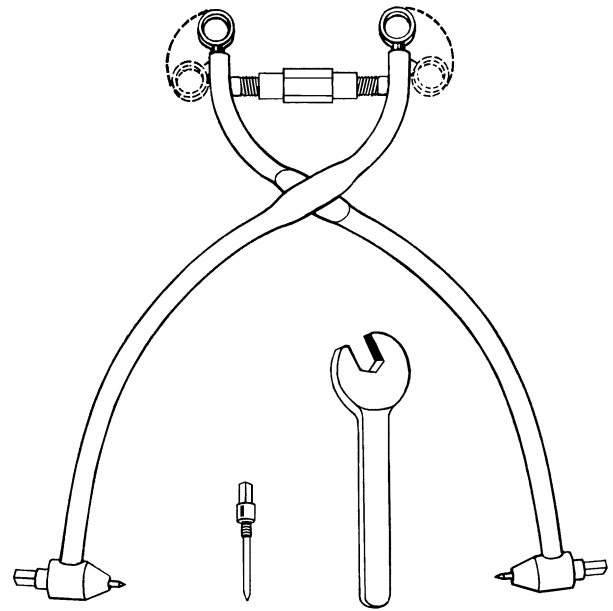

**74410-90** Crutchfield Traction Tong

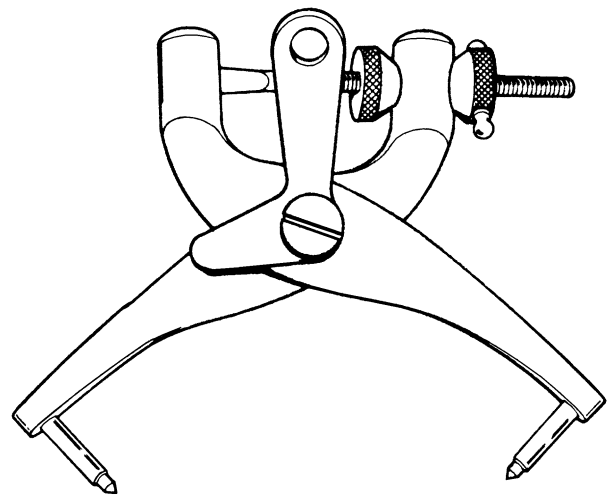

## Trephines

**75000-10** Scoville Centering Drill, guarded with adjustable depth, 3.3mm drill, standard brace fitting

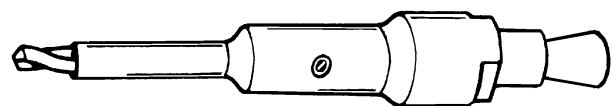

## Trephines

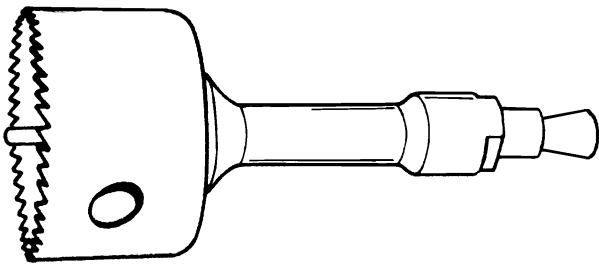

- 75010-38** Scoville Trephine, with round and sharp pins, 38mm, standard brace fitting
- 75010-44** Scoville Trephine, with round and sharp pins, 44mm, standard brace fitting
- 75010-51** Scoville Trephine, with round and sharp pins, 51mm, standard brace fitting

## Biopsy Forceps

**81000-35** Lloyd Davis Sigmoidoscope Biopsy Forcep, 350mm effective length

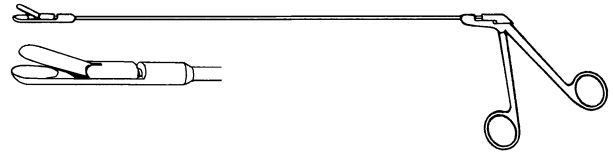

**81010-43** Officer Biopsy Forcep, 8mm cup jaws, 430mm effective length

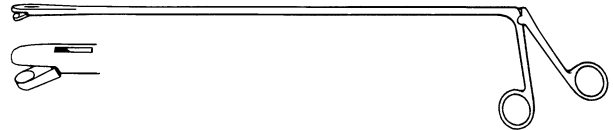

**81015-35** St.Marks Biopsy Forcep, complete, 350mm  
**81015-40** St.Marks Biopsy Forcep, complete, 400mm

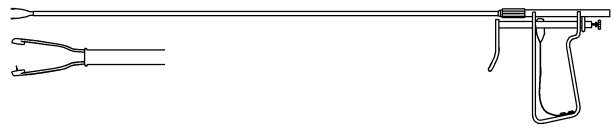

**81020-25** Yeoman Biopsy Forcep, basket-jawed, 250mm effective length

**81020-35** Yeoman Biopsy Forcep, basket-jawed, 355mm effective length

**81020-43** Yeoman Biopsy Forcep, basket-jawed, 430mm effective length



## Clamps

**81100-23** Finch Excision Atraumatic Clamp, hollowed jaws, 230mm, 75mm blade

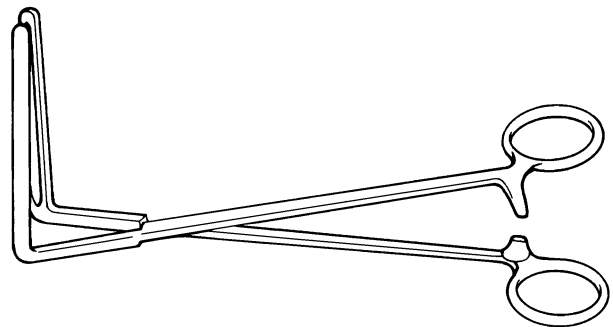

## Clamps - Atraumatic

**81200-26** Hayes Atraumatic Clamp, jaws angled 70 degrees, 260mm, 80mm jaws

**81200-28** Hayes Atraumatic Clamp, jaws angled 70 degrees, 280mm, 100mm jaws

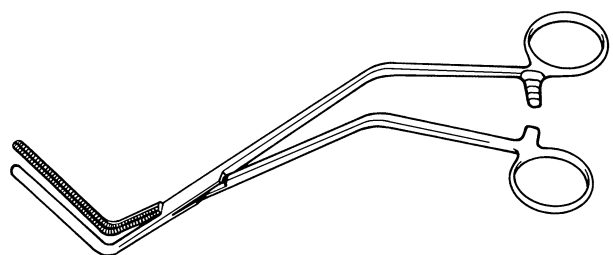

# Proctology

## Dilators

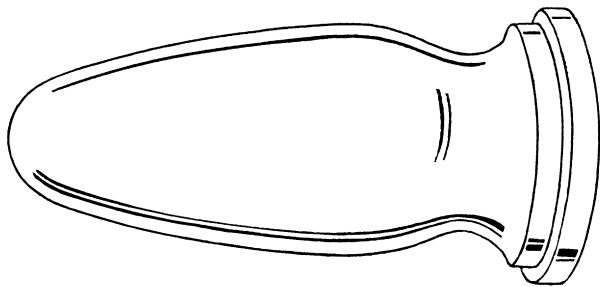

**81300-20** Lord Rectal Dilator, perspex, 20mm - 35mm

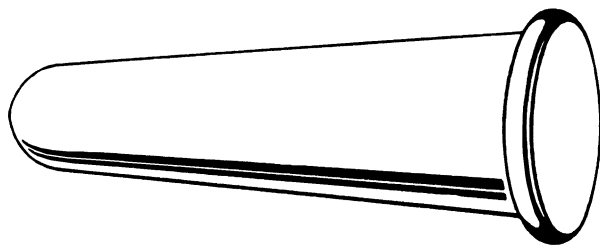

**81310-14** St.Marks Rectal Dilator, aluminium, small, 14mm - 19mm

**81310-16** St.Marks Rectal Dilator, aluminium, large, 16mm - 25mm

**81320-14** St.Marks Rectal Dilator, s/s, small, 14mm - 19mm

**81320-16** St.Marks Rectal Dilator, s/s, large, 16mm - 25mm

## Directors

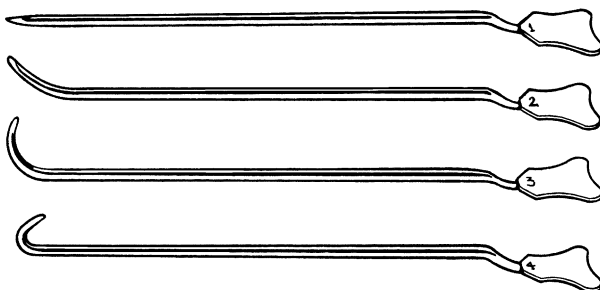

**81400-10** Lockhart Mummery Fistula Director, 165mm, No.1, straight

**81400-20** Lockhart Mummery Fistula Director, 165mm, No.2, 45 degree curve

**81400-30** Lockhart Mummery Fistula Director, 165mm, No.3, 90 degree curve

**81400-40** Lockhart Mummery Fistula Director, 165mm, No.4, retrograde

**81400-90** Lockhart Mummery Fistula Director, 165mm, set of 4 sizes

## Dissecting Forceps

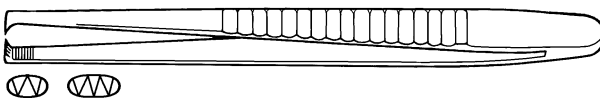

**81500-15** Officer Dissecting Forcep, 2/3 teeth, 150mm

**81500-20** Officer Dissecting Forcep, 2/3 teeth, 200mm

**81510-15** Officer Dissecting Forcep, 4/5 teeth, 150mm

**81510-20** Officer Dissecting Forcep, 4/5 teeth, 200mm

**81510-25** Officer Dissecting Forcep, 4/5 teeth, 250mm

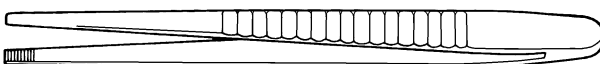

**81520-15** Officer Dissecting Forcep, serrated, 150mm

**81520-20** Officer Dissecting Forcep, serrated, 200mm

**81520-25** Officer Dissecting Forcep, serrated, 250mm



## Haemorrhoid Ligators

**81600-50** Barron Haemorrhoid Ligator, loading cone only

**81600-90** Barron Haemorrhoid Ligator, complete with loading cone, 215mm

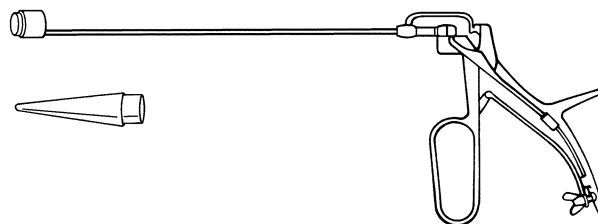

**81610-10** Simple Pattern Haemorrhoid Ligator, ligator only

**81610-60** Simple Pattern Haemorrhoid Ligator, s/s loading cone only

**81610-90** Simple Pattern Haemorrhoid Ligator, complete with s/s loading cone

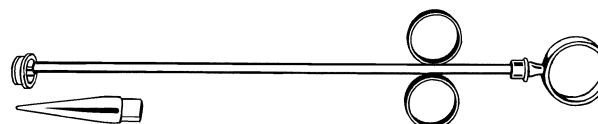

**81645-09** Suction Model Haemorrhoid Ligator, black nylon handle, 9mm deep x 10mm bore cup only

**81645-16** Suction Model Haemorrhoid Ligator, black nylon handle, 16mm deep x 10mm bore cup only

**81645-20** Suction Model Haemorrhoid Ligator, black nylon handle, ligator only, 1 x 9mm deep cup, 1 x 16mm deep cup

**81645-50** Suction Model Haemorrhoid Ligator, black nylon handle, s/s loading cone only

**81645-90** Suction Model Haemorrhoid Ligator, black nylon handle, complete with 1 x 9mm deep cup, 1 x 16mm deep cup, 1 x s/s loading cone

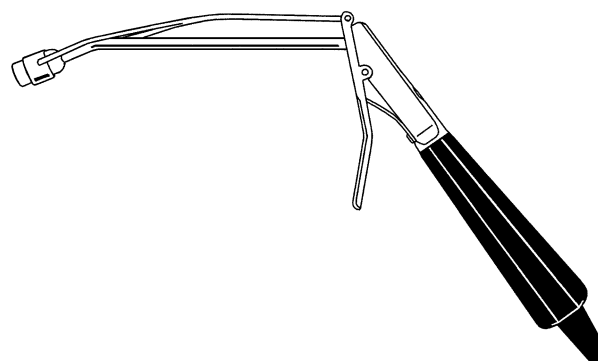

## Proctoscopes

**81700-05** Kelly Proctoscope, with obturator, 22mm x 50mm

**81700-10** Kelly Proctoscope, with obturator, 22mm x 100mm

**81700-14** Kelly Proctoscope, with obturator, 22mm x 140mm

**81700-20** Kelly Proctoscope, with obturator, 22mm x 200mm

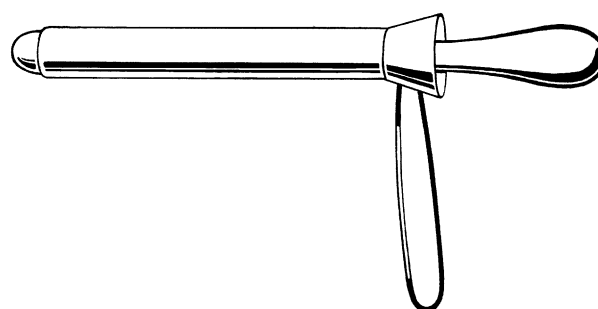

# Proctology

## Proctoscopes

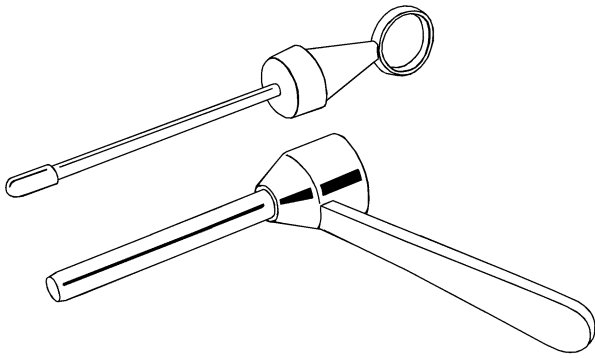

**81710-10** Lloyd Davis Proctoscope, with obturator, child

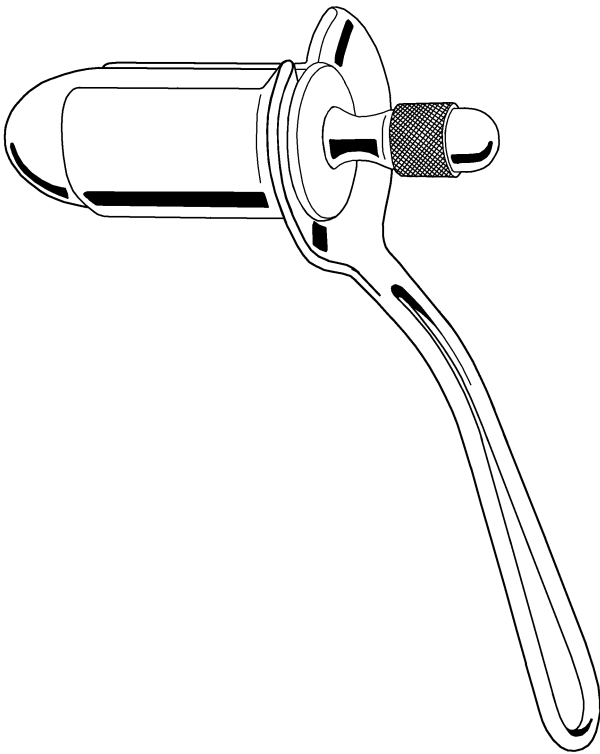

**81720-07** Fansler Operating Proctoscope, s/s, slotted tube, wire handle, 35mm x 75mm, 18mm slot

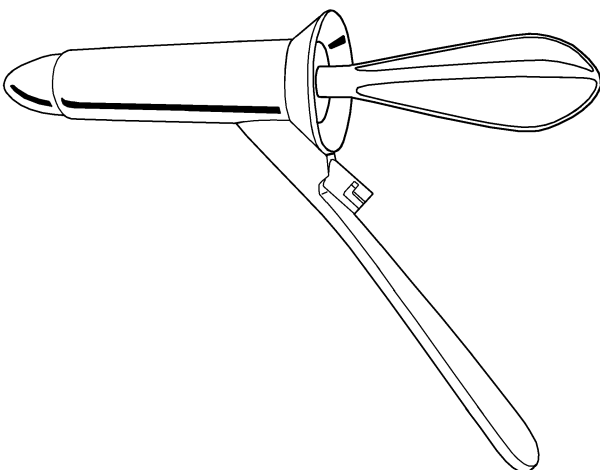

**81730-14** St.Marks Proctoscope, s/s, with obturator, child, 71mm long x 14mm diameter

**81730-21** St.Marks Proctoscope, s/s, with obturator, adult, 95mm long x 21mm diameter

- 81850-10** Abel Rectal Speculum, s/s, with solid conical obturator, with fibrelight stem
- 81850-50** Abel Rectal Speculum, fibrelight stem only
- 81851-10** Abel Rectal Speculum, s/s, with solid conical obturator, without light stem

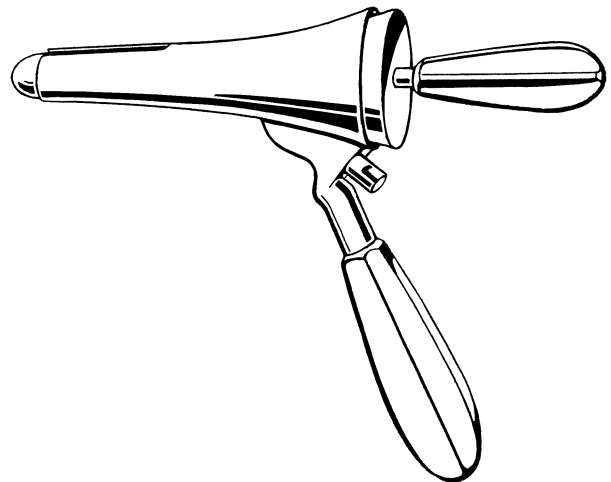

- 81900-18** Kelly Rectal Speculum, with obturator, 18mm x 50mm
- 81900-23** Kelly Rectal Speculum, with obturator, 23mm x 65mm

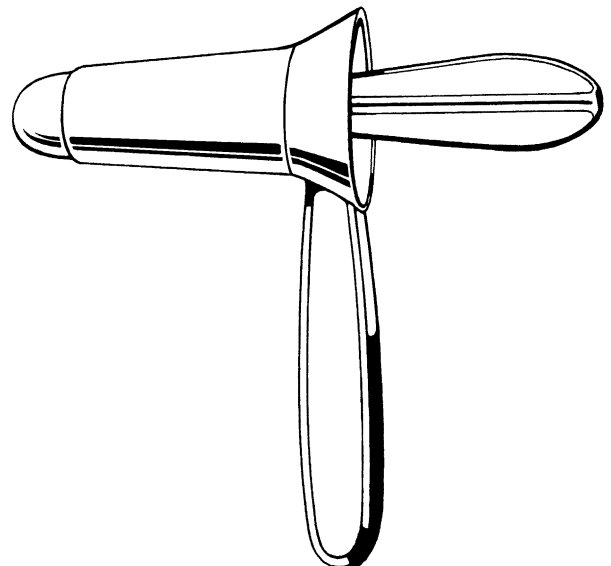

- 81910-17** Naunton Morgan Rectal Speculum, s/s, with fibrelight stem, 17mm diameter
- 81910-20** Naunton Morgan Rectal Speculum, s/s, with fibrelight stem, 20mm diameter
- 81910-24** Naunton Morgan Rectal Speculum, s/s, with fibrelight stem, 24mm diameter
- 81910-50** Naunton Morgan Rectal Speculum, fibrelight stem only

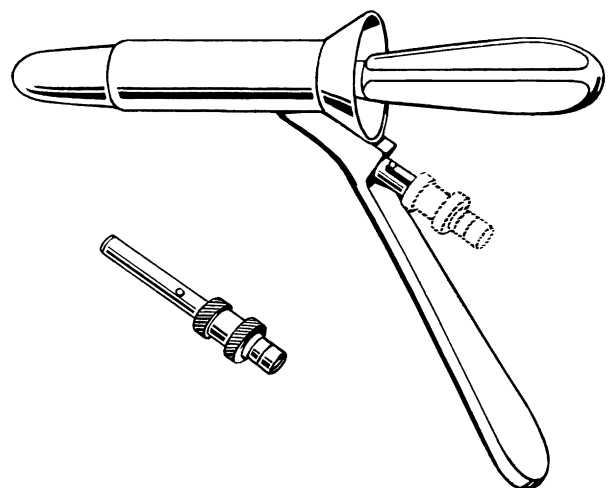

## Retractors - Self Retaining

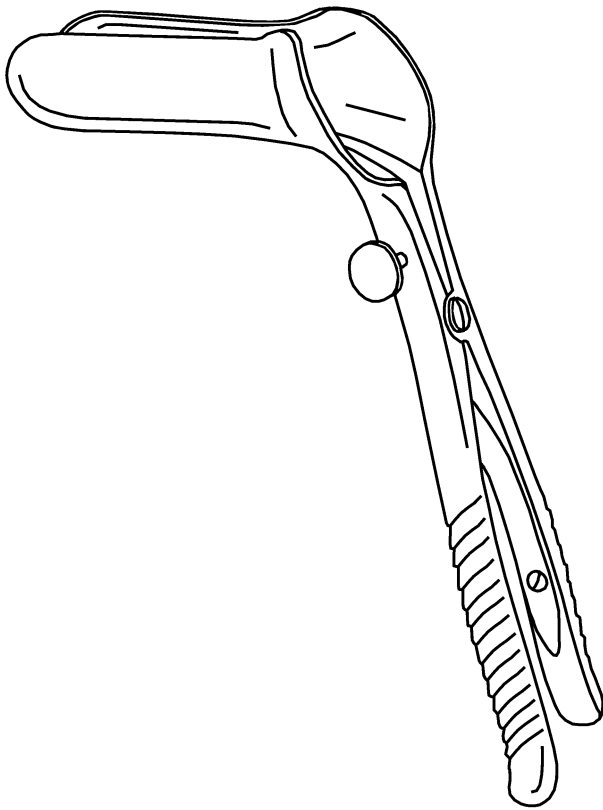

**81960-10** Eisenhammer Anal Self Retaining Retractor, with knurled thumb screw

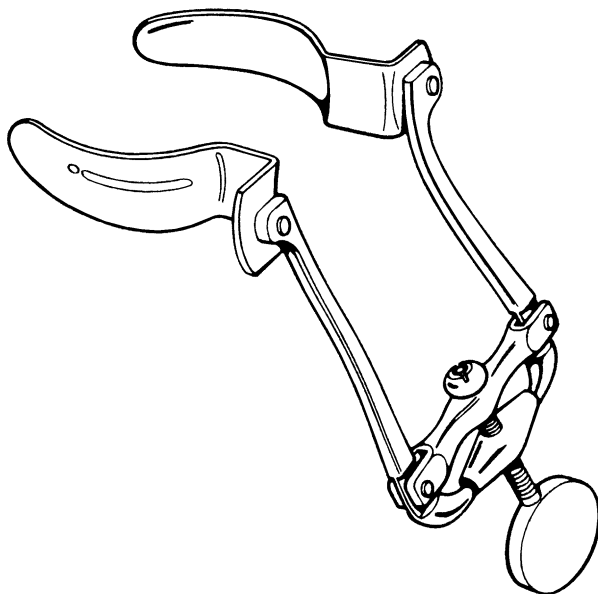

- 82000-13** Park Anal Self Retaining Retractor, 130mm, adult blades, 95mm
- 82000-50** Park Anal Self Retaining Retractor, 130mm, frame only, bayonet fitting
- 82000-70** Park Anal Self Retaining Retractor, 130mm, child blades, 70mm
- 82000-75** Park Anal Self Retaining Retractor, 130mm, sphincterotomy blades, 75mm

## Retractors - Self Retaining

- 82010-10** Park Combined Self Retaining Retractor, centre blade only, 95mm
- 82010-15** Park Combined Self Retaining Retractor, centre blade with fibreight only, 95mm
- 82010-20** Park Combined Self Retaining Retractor, child blades only, ball fitting, pair, 70mm
- 82010-22** Park Combined Self Retaining Retractor, child blades only, bayonet fitting, pair, 70mm
- 82010-30** Park Combined Self Retaining Retractor, adult blades only, ball fitting, pair, 95mm
- 82010-32** Park Combined Self Retaining Retractor, adult blades only, bayonet fitting, pair, 95mm
- 82010-40** Park Combined Self Retaining Retractor, sphincterotomy blades only, ball fitting, pair, 75mm
- 82010-42** Park Combined Self Retaining Retractor, sphincterotomy blades only, bayonet fitting, pair, 75mm
- 82010-50** Park Combined Self Retaining Retractor, anastomosis blades only, ball fitting, pair, 90mm
- 82010-52** Park Combined Self Retaining Retractor, anastomosis blades only, bayonet fitting, pair, 90mm
- 82010-80** Park Combined Self Retaining Retractor, frame only, ball fitting
- 82010-90** Park Combined Self Retaining Retractor, complete, ball fitting, 2 x adult blades, 2 x sphincterotomy blades, centre blade

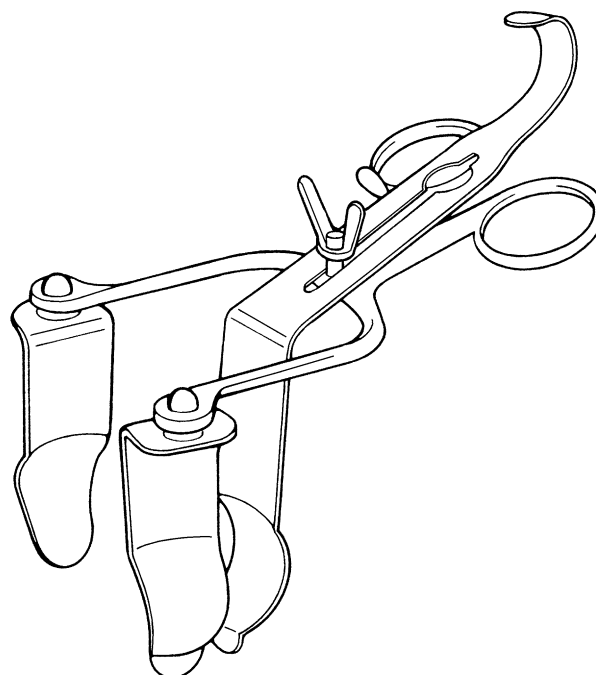

## Scissors

- 82110-30** Goligher Scissor, curved, 300mm

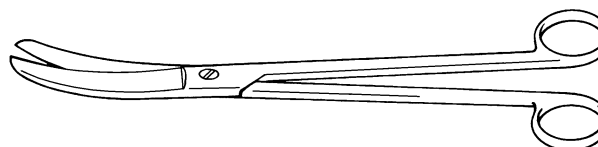

- 82120-30** Goligher Scissor, straight, 300mm

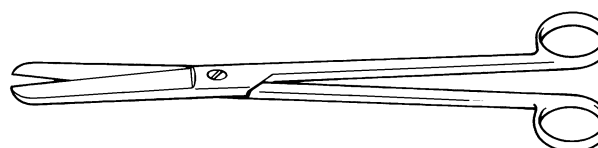

- 82130-26** Lloyd-Davis Rectal Scissor, curved on flats, flattened blades, blunt points, 265mm

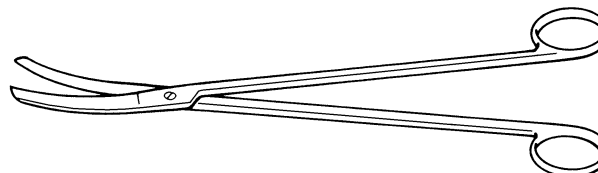

# Proctology

## Scissors

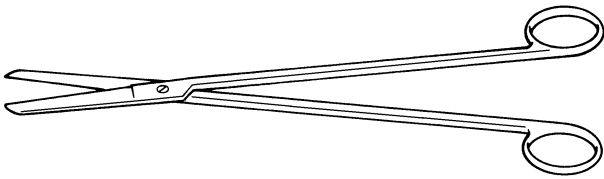

**82140-26** Lloyd-Davis Rectal Scissor, straight, flattened blades, blunt points, 265mm

## Sigmoidoscopes

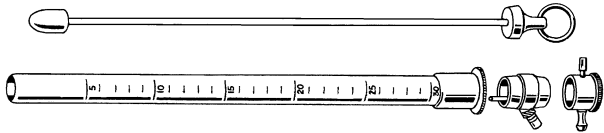

- 82200-10** Lloyd-Davis Sigmoidoscope, inflation window only
- 82200-15** Lloyd-Davis Sigmoidoscope, body only
- 82200-20** Lloyd-Davis Sigmoidoscope, conventional lamp nut only
- 82200-25** Lloyd-Davis Sigmoidoscope, conventional lamp stem only
- 82200-30** Lloyd-Davis Sigmoidoscope, conventional lamp bulb only
- 82200-35** Lloyd-Davis Sigmoidoscope, conventional lamp cable only
- 82200-40** Lloyd-Davis Sigmoidoscope, fibrelight nut only
- 82200-45** Lloyd-Davis Sigmoidoscope, fibrelight stem only
- 82200-55** Lloyd-Davis Sigmoidoscope, wooden box only, to take combined set
- 82200-60** Lloyd-Davis Sigmoidoscope, wooden box only, to take small set
- 82200-65** Lloyd-Davis Sigmoidoscope, wooden box only, to take large set
- 82210-85** Lloyd-Davis Sigmoidoscope, combined set, case, 250mm x 15mm & 300mm x 20mm, conventional lamp, window
- 82210-90** Lloyd-Davis Sigmoidoscope, combined set, case, 250mm x 15mm & 300mm x 20mm, fibrelight, window
- 82220-50** Lloyd-Davis Sigmoidoscope, tube and obturator only, 250mm x 15mm
- 82220-85** Lloyd-Davis Sigmoidoscope, small set, case, 250mm x 15mm, conventional lamp, window
- 82220-90** Lloyd-Davis Sigmoidoscope, small set, case, 250mm x 15mm, fibrelight, window
- 82230-50** Lloyd-Davis Sigmoidoscope, tube and obturator only, 300mm x 20mm
- 82230-85** Lloyd-Davis Sigmoidoscope, large set, case, 300mm x 20mm, conventional lamp, window
- 82230-90** Lloyd-Davis Sigmoidoscope, large set, case, 300mm x 20mm, fibrelight, window

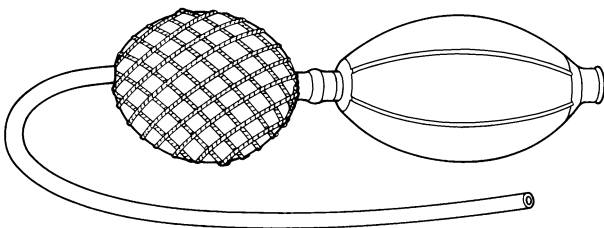

**82200-05** Lloyd-Davis Sigmoidoscope, inflation bellows only, rubber, double

82300-38 Richards Suction Tube, c/p, 385mm

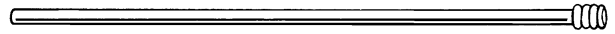

## Bougies

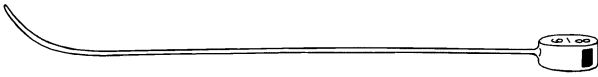

- 91000-06** Addison Urethral Bougie, s/s, tapered, welded, 175mm, 4/6FG
- 91000-07** Addison Urethral Bougie, s/s, tapered, welded, 175mm, 5/7FG
- 91000-08** Addison Urethral Bougie, s/s, tapered, welded, 175mm, 6/8FG
- 91000-09** Addison Urethral Bougie, s/s, tapered, welded, 175mm, 7/9FG
- 91000-10** Addison Urethral Bougie, s/s, tapered, welded, 175mm, 8/10FG
- 91000-11** Addison Urethral Bougie, s/s, tapered, welded, 175mm, 9/11FG
- 91000-12** Addison Urethral Bougie, s/s, tapered, welded, 175mm, 10/12FG
- 91000-13** Addison Urethral Bougie, s/s, tapered, welded, 175mm, 11/13FG
- 91000-14** Addison Urethral Bougie, s/s, tapered, welded, 175mm, 12/14FG
- 91000-15** Addison Urethral Bougie, s/s, tapered, welded, 175mm, 13/15FG
- 91000-16** Addison Urethral Bougie, s/s, tapered, welded, 175mm, 14/16FG
- 91000-17** Addison Urethral Bougie, s/s, tapered, welded, 175mm, 15/17FG
- 91000-18** Addison Urethral Bougie, s/s, tapered, welded, 175mm, 16/18FG
- 91000-19** Addison Urethral Bougie, s/s, tapered, welded, 175mm, 17/19FG
- 91000-20** Addison Urethral Bougie, s/s, tapered, welded, 175mm, 18/20FG
- 91000-21** Addison Urethral Bougie, s/s, tapered, welded, 175mm, 19/21FG
- 91000-22** Addison Urethral Bougie, s/s, tapered, welded, 175mm, 20/22FG
- 91000-23** Addison Urethral Bougie, s/s, tapered, welded, 175mm, 21/23FG
- 91000-24** Addison Urethral Bougie, s/s, tapered, welded, 175mm, 22/24FG

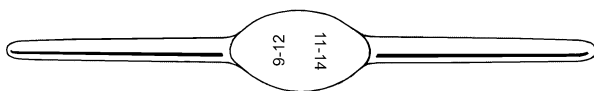

- 91006-01** Canny Ryall Meatal Bougie, s/s, double ended, welded, 160mm, 1/4EG and 3/6EG
- 91006-05** Canny Ryall Meatal Bougie, s/s, double ended, welded, 160mm, 5/8EG and 7/10EG
- 91006-09** Canny Ryall Meatal Bougie, s/s, double ended, welded, 160mm, 9/12EG and 11/14EG
- 91006-13** Canny Ryall Meatal Bougie, s/s, double ended, welded, 160mm, 13/16EG and 15/18EG
- 91006-17** Canny Ryall Meatal Bougie, s/s, double ended, welded, 160mm, 17/20EG and 19/22EG
- 91006-21** Canny Ryall Meatal Bougie, s/s, double ended, welded, 160mm, 21/23EG and 22/24EG
- 91006-26** Canny Ryall Meatal Bougie, s/s, double ended, welded, 160mm, 26/28EG and 29/31EG



- 91010-10** Clutton Urethral Bougie, s/s, tapered, 265mm, 6/10FG
- 91010-12** Clutton Urethral Bougie, s/s, tapered, 265mm, 8/12FG
- 91010-14** Clutton Urethral Bougie, s/s, tapered, 265mm, 10/14FG
- 91010-16** Clutton Urethral Bougie, s/s, tapered, 265mm, 12/16FG
- 91010-18** Clutton Urethral Bougie, s/s, tapered, 265mm, 14/18FG
- 91010-20** Clutton Urethral Bougie, s/s, tapered, 265mm, 16/20FG
- 91010-22** Clutton Urethral Bougie, s/s, tapered, 265mm, 18/22FG
- 91010-24** Clutton Urethral Bougie, s/s, tapered, 265mm, 20/24FG
- 91010-26** Clutton Urethral Bougie, s/s, tapered, 265mm, 22/26FG
- 91010-28** Clutton Urethral Bougie, s/s, tapered, 265mm, 24/28FG
- 91010-30** Clutton Urethral Bougie, s/s, tapered, 265mm, 26/30FG
- 91010-32** Clutton Urethral Bougie, s/s, tapered, 265mm, 28/32FG
- 91010-90** Clutton Urethral Bougie, s/s, tapered, set of 12

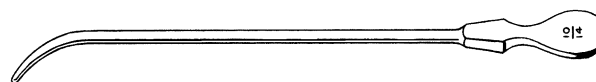

- 91020-07** Hey Groves Retrograde Bougie, s/s, 170mm, 4/7EG
- 91020-09** Hey Groves Retrograde Bougie, s/s, 170mm, 6/9EG
- 91020-11** Hey Groves Retrograde Bougie, s/s, 170mm, 8/11EG
- 91020-90** Hey Groves Retrograde Bougie, s/s, set of 3

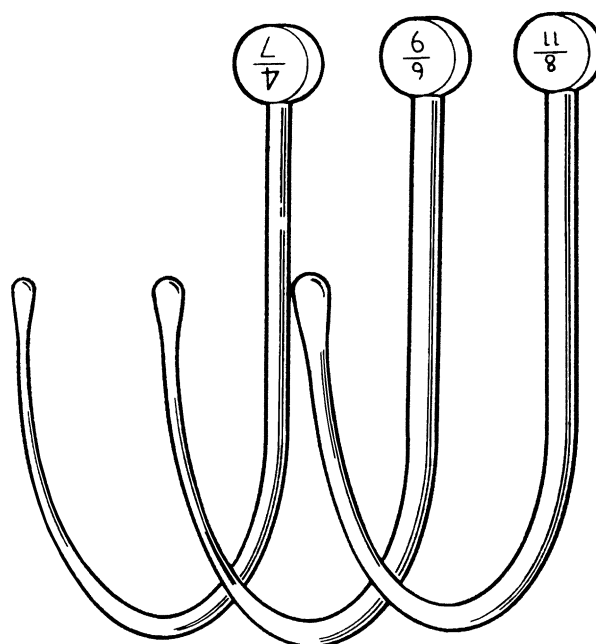

## Bougies

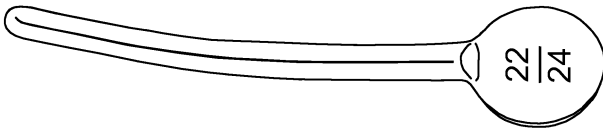

- 91025-10** Kidd Urethral Bougie, s/s, welded, 120mm, 10/12FG
- 91025-12** Kidd Urethral Bougie, s/s, welded, 120mm, 12/14FG
- 91025-14** Kidd Urethral Bougie, s/s, welded, 120mm, 14/16FG
- 91025-16** Kidd Urethral Bougie, s/s, welded, 120mm, 16/18FG
- 91025-18** Kidd Urethral Bougie, s/s, welded, 120mm, 18/20FG
- 91025-20** Kidd Urethral Bougie, s/s, welded, 120mm, 20/22FG
- 91025-22** Kidd Urethral Bougie, s/s, welded, 120mm, 22/24FG
- 91025-24** Kidd Urethral Bougie, s/s, welded, 120mm, 24/26FG
- 91025-26** Kidd Urethral Bougie, s/s, welded, 120mm, 26/28FG
- 91025-28** Kidd Urethral Bougie, s/s, welded, 120mm, 28/30FG
- 91025-30** Kidd Urethral Bougie, s/s, welded, 120mm, 30/32FG

- 91030-01** Lister Urethral Bougie, s/s, olive end, 270mm, 00/1EG
- 91030-02** Lister Urethral Bougie, s/s, olive end, 270mm, 0/2EG
- 91030-03** Lister Urethral Bougie, s/s, olive end, 270mm, 0.5/3EG
- 91030-04** Lister Urethral Bougie, s/s, olive end, 270mm, 1/4EG
- 91030-05** Lister Urethral Bougie, s/s, olive end, 270mm, 2/5EG
- 91030-06** Lister Urethral Bougie, s/s, olive end, 270mm, 3/6EG
- 91030-07** Lister Urethral Bougie, s/s, olive end, 270mm, 4/7EG
- 91030-08** Lister Urethral Bougie, s/s, olive end, 270mm, 5/8EG
- 91030-09** Lister Urethral Bougie, s/s, olive end, 270mm, 6/9EG
- 91030-10** Lister Urethral Bougie, s/s, olive end, 270mm, 7/10EG
- 91030-11** Lister Urethral Bougie, s/s, olive end, 270mm, 8/11EG
- 91030-12** Lister Urethral Bougie, s/s, olive end, 270mm, 9/12EG
- 91030-13** Lister Urethral Bougie, s/s, olive end, 270mm, 10/13EG
- 91030-14** Lister Urethral Bougie, s/s, olive end, 270mm, 11/14EG
- 91030-15** Lister Urethral Bougie, s/s, olive end, 270mm, 12/15EG
- 91030-16** Lister Urethral Bougie, s/s, olive end, 270mm, 13/16EG
- 91030-17** Lister Urethral Bougie, s/s, olive end, 270mm, 14/17EG
- 91030-18** Lister Urethral Bougie, s/s, olive end, 270mm, 15/18EG
- 91030-19** Lister Urethral Bougie, s/s, olive end, 270mm, 16/19EG
- 91030-20** Lister Urethral Bougie, s/s, olive end, 270mm, 17/20EG
- 91030-21** Lister Urethral Bougie, s/s, olive end, 270mm, 18/21EG
- 91030-90** Lister Urethral Bougie, s/s, olive end, 270mm, set of 21 sizes



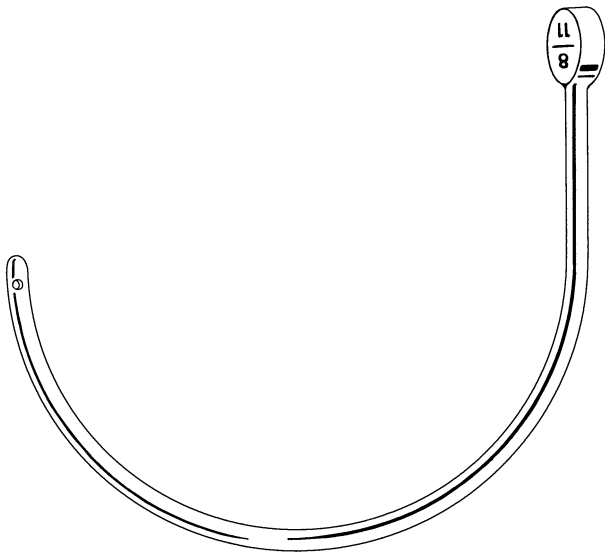

**91038-08** Turner Warwick Modified Hey Groves Retrograde Bougie, s/s, 170mm, 8/11EG

- 91046-04** Winsbury White Urethral Bougie, s/s, welded, 200mm, 4/6FG
- 91046-05** Winsbury White Urethral Bougie, s/s, welded, 200mm, 5/7FG
- 91046-06** Winsbury White Urethral Bougie, s/s, welded, 200mm, 6/8FG
- 91046-07** Winsbury White Urethral Bougie, s/s, welded, 200mm, 7/9FG
- 91046-08** Winsbury White Urethral Bougie, s/s, welded, 200mm, 8/10FG
- 91046-09** Winsbury White Urethral Bougie, s/s, welded, 200mm, 9/11FG
- 91046-10** Winsbury White Urethral Bougie, s/s, welded, 200mm, 10/12FG
- 91046-11** Winsbury White Urethral Bougie, s/s, welded, 200mm, 11/13FG
- 91046-12** Winsbury White Urethral Bougie, s/s, welded, 200mm, 12/14FG
- 91046-13** Winsbury White Urethral Bougie, s/s, welded, 200mm, 13/15FG
- 91046-14** Winsbury White Urethral Bougie, s/s, welded, 200mm, 14/16FG
- 91046-15** Winsbury White Urethral Bougie, s/s, welded, 200mm, 15/17FG
- 91046-16** Winsbury White Urethral Bougie, s/s, welded, 200mm, 16/18FG
- 91046-17** Winsbury White Urethral Bougie, s/s, welded, 200mm, 17/19FG
- 91046-18** Winsbury White Urethral Bougie, s/s, welded, 200mm, 18/20FG
- 91046-19** Winsbury White Urethral Bougie, s/s, welded, 200mm, 19/21FG
- 91046-20** Winsbury White Urethral Bougie, s/s, welded, 200mm, 20/22FG
- 91046-21** Winsbury White Urethral Bougie, s/s, welded, 200mm, 21/23FG
- 91046-22** Winsbury White Urethral Bougie, s/s, welded, 200mm, 22/24FG
- 91046-23** Winsbury White Urethral Bougie, s/s, welded, 200mm, 23/25FG
- 91046-24** Winsbury White Urethral Bougie, s/s, welded, 200mm, 24/26FG

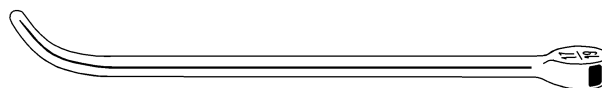

# Urology

## Bougies

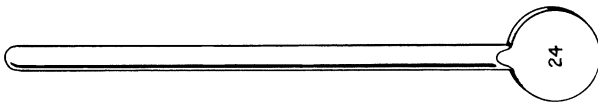

- 91050-10 Wyndham Powell Bougie, s/s, 170mm, 10FG
- 91050-11 Wyndham Powell Bougie, s/s, 170mm, 11FG
- 91050-12 Wyndham Powell Bougie, s/s, 170mm, 12FG
- 91050-13 Wyndham Powell Bougie, s/s, 170mm, 13FG
- 91050-14 Wyndham Powell Bougie, s/s, 170mm, 14FG
- 91050-15 Wyndham Powell Bougie, s/s, 170mm, 15FG
- 91050-16 Wyndham Powell Bougie, s/s, 170mm, 16FG
- 91050-17 Wyndham Powell Bougie, s/s, 170mm, 17FG
- 91050-18 Wyndham Powell Bougie, s/s, 170mm, 18FG
- 91050-19 Wyndham Powell Bougie, s/s, 170mm, 19FG
- 91050-20 Wyndham Powell Bougie, s/s, 170mm, 20FG
- 91050-21 Wyndham Powell Bougie, s/s, 170mm, 21FG
- 91050-22 Wyndham Powell Bougie, s/s, 170mm, 22FG
- 91050-23 Wyndham Powell Bougie, s/s, 170mm, 23FG
- 91050-24 Wyndham Powell Bougie, s/s, 170mm, 24FG
- 91050-25 Wyndham Powell Bougie, s/s, 170mm, 25FG
- 91050-26 Wyndham Powell Bougie, s/s, 170mm, 26FG
- 91050-27 Wyndham Powell Bougie, s/s, 170mm, 27FG
- 91050-28 Wyndham Powell Bougie, s/s, 170mm, 28FG
- 91050-29 Wyndham Powell Bougie, s/s, 170mm, 29FG
- 91050-30 Wyndham Powell Bougie, s/s, 170mm, 30FG
- 91050-31 Wyndham Powell Bougie, s/s, 170mm, 31FG
- 91050-32 Wyndham Powell Bougie, s/s, 170mm, 32FG
- 91050-33 Wyndham Powell Bougie, s/s, 170mm, 33FG
- 91050-34 Wyndham Powell Bougie, s/s, 170mm, 34FG
- 91050-35 Wyndham Powell Bougie, s/s, 170mm, 35FG
- 91050-36 Wyndham Powell Bougie, s/s, 170mm, 36FG
- 91050-37 Wyndham Powell Bougie, s/s, 170mm, 37FG
- 91050-38 Wyndham Powell Bougie, s/s, 170mm, 38FG
- 91050-39 Wyndham Powell Bougie, s/s, 170mm, 39FG
- 91050-90 Wyndham Powell Bougie, s/s, 170mm, set of 18 sizes (15FG - 32FG)

## Catheter Introducers



- 91100-45 Foley Catheter Introducer, curved, 455mm



- 91110-45 Foley Catheter Introducer, straight, 455mm
- 91112-02 Foley Catheter Introducer, straight, 510mm, small tip, 2mm



- 91120-02 Foley Catheter Introducer With Guyon Curve, curved, 430mm, small tip, 2mm
- 91120-04 Foley Catheter Introducer With Guyon Curve, curved, 430mm, large tip, 4mm

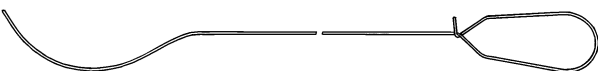

- 91130-02 Foley Catheter Introducer With Guyon Curve, deep curve, 510mm, small tip, 2mm

## Catheter Introducers

**91135-02** Guyon Catheter Introducer, curved, 510mm, small tip, 2mm



**91138-03** Guyon Catheter Introducer, curved with slide, no handle, small tip, 3mm



**91140-12** Maryfield Catheter Introducer, s/s, curved, 300mm, small, for 12 and 14 FCG

**91140-16** Maryfield Catheter Introducer, s/s, curved, 300mm, medium, for 16 and 18 FCG

**91140-24** Maryfield Catheter Introducer, s/s, curved, 300mm, large, for 24 and 26 FCG

**91145-12** Maryfield Catheter Introducer, paediatric, s/s, curved, 215mm, small, for 12 and 14 FCG



## Circumcision Shields

**91200-10** Jewish Pattern Circumcision Shield, s/s, 65mm, large, 1.6mm wide slot

**91200-20** Jewish Pattern Circumcision Shield, s/s, 65mm, medium, 1.2mm wide slot

**91200-30** Jewish Pattern Circumcision Shield, s/s, 65mm, small, 0.8mm wide slot

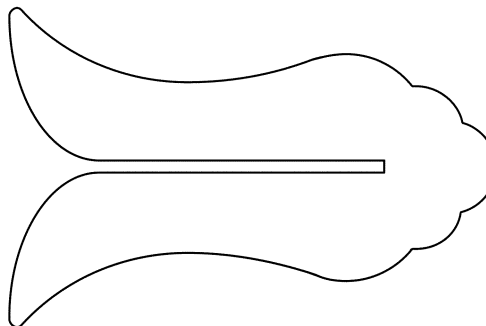

## Clamps

**91300-20** Thomson-Walker Pedicle Clamp, angled, screw joint, 200mm

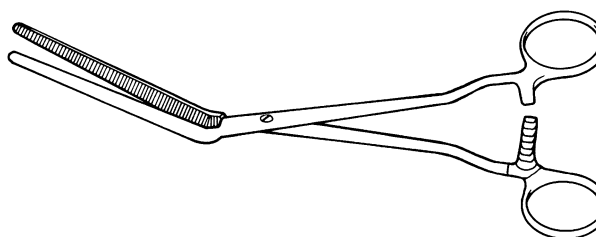

**91310-11** Thomson-Walker Penile Clamp, cross action, 115mm

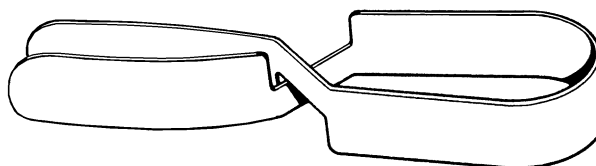

# Urology

## Clamps - Atraumatic

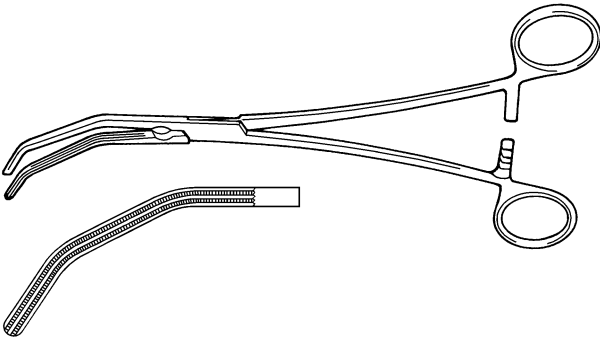

**91400-26** Herrick Kidney Pedicle Atraumatic Clamp, 1/2 serrations, double angle, 265mm

## Dilators

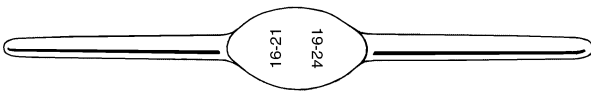

- 91500-04** Turner Warwick Dilator, s/s, double ended, 160mm, 4/9FG and 7/12FG
- 91500-10** Turner Warwick Dilator, s/s, double ended, 160mm, 10/15FG and 13/18FG
- 91500-16** Turner Warwick Dilator, s/s, double ended, 160mm, 16/21FG and 19/24FG
- 91500-22** Turner Warwick Dilator, s/s, double ended, 160mm, 22/27FG and 25/30FG
- 91500-28** Turner Warwick Dilator, s/s, double ended, 160mm, 28/33FG and 31/36FG
- 91500-90** Turner Warwick Dilator, s/s, double ended, 160mm, set of 5

## Dissecting Forceps



**91600-23** Millins Dissecting Forcep, 3/4 teeth, 225mm

## Gorgets

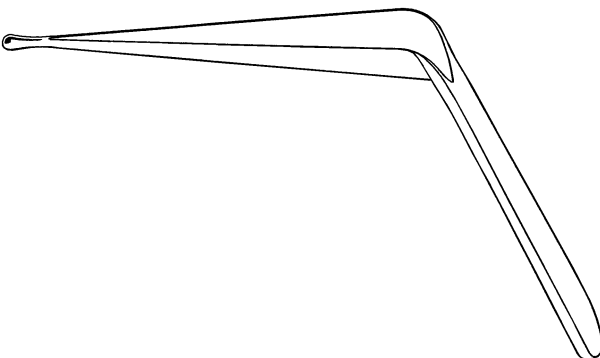

**91750-20** Teales Gorget, tapered from 20mm to a probe point



## Needleholders

- 91800-10** Millin Boomerang Needleholder, 225mm, needle, large
- 91800-20** Millin Boomerang Needleholder, 225mm, needle, medium
- 91800-30** Millin Boomerang Needleholder, 225mm, needle, small
- 91800-90** Millin Boomerang Needleholder, 225mm, complete, with 3 needles

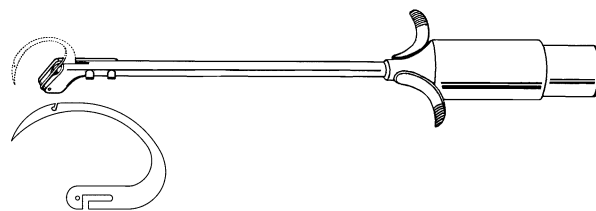

## Needles

- 91900-03** Turner Warwick Posterior Urethral Suture Needle, 30 deg, 200mm
- 91900-07** Turner Warwick Posterior Urethral Suture Needle, 70 deg, 200mm
- 91900-09** Turner Warwick Posterior Urethral Suture Needle, 90 deg, 200mm
- 91900-90** Turner Warwick Posterior Urethral Suture Needle, set of 3, 30 deg, 70 deg, 90 deg, 200mm

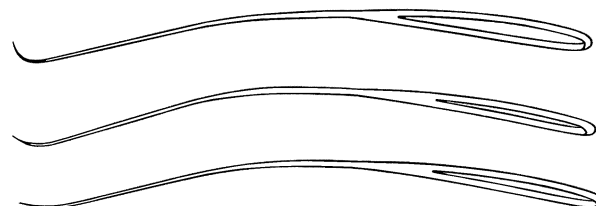

## Retractors

- 92180-12** Blandy Modified Gil Vernet Retractor, 12mm
- 92180-18** Blandy Modified Gil Vernet Retractor, 18mm
- 92180-25** Blandy Modified Gil Vernet Retractor, 25mm

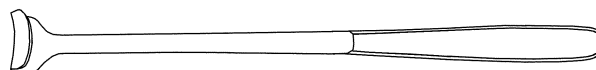

- 92200-09** Gil Vernet Retractor, 9mm wide blade
- 92200-11** Gil Vernet Retractor, 11mm wide blade
- 92200-13** Gil Vernet Retractor, 13mm wide blade
- 92200-15** Gil Vernet Retractor, 15mm wide blade
- 92200-18** Gil Vernet Retractor, 18mm wide blade

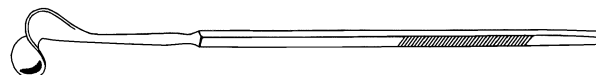

- 92210-24** Millin Bladder Neck Spreader, cross action, 240mm

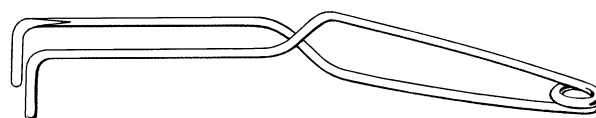

- 92220-24** Millin Bladder Neck Spreader, cross action, with rack, 240mm

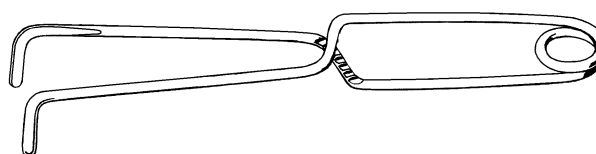

## Retractors

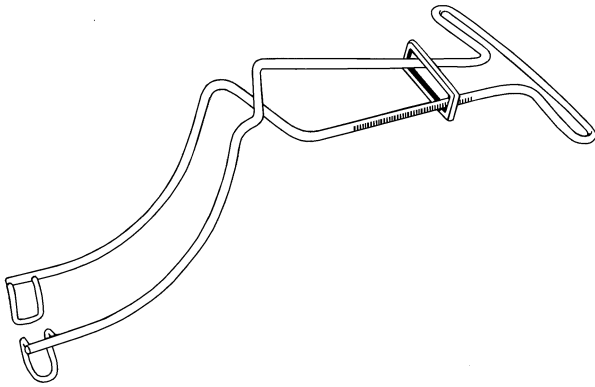

**92225-24** Turner Warwick Bladder Neck Spreader, cross action, 240mm

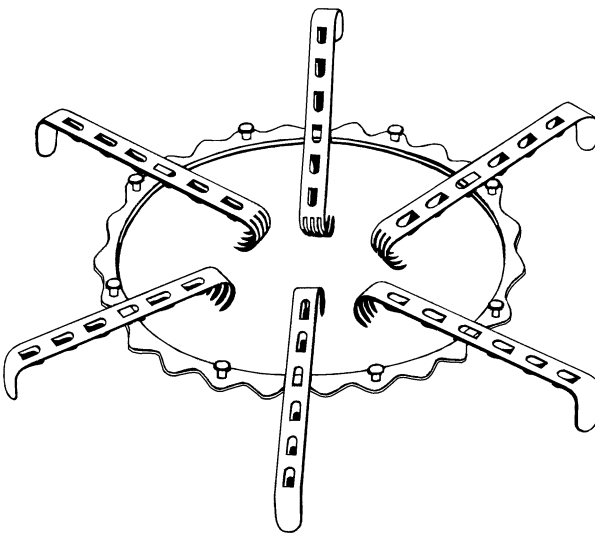

**92230-10** Turner Warwick Urological Retractor, curved claw blade only, 13mm x 14mm

**92230-20** Turner Warwick Urological Retractor, oval frame only, 180mm x 140mm

**92230-90** Turner Warwick Urological Retractor, complete with 1 ring and 6 blades

## Retractors - Self Retaining

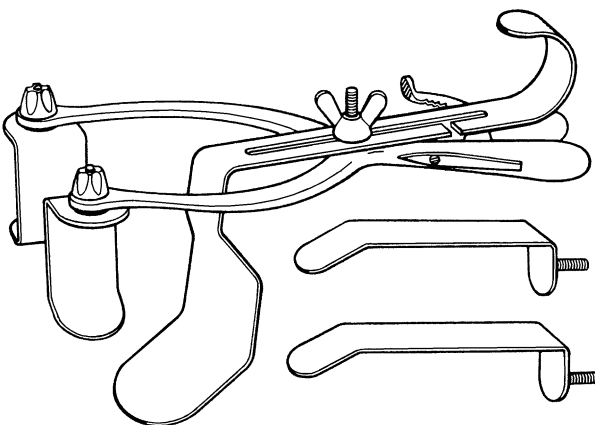

**92300-90** Millin Retropubic Self Retaining Retractor, complete with 2 sets of blades

Retractors - Self Retaining

92310-90 St.Marks (Perineal) Self Retaining Retractor, swivel blades, towel pegs

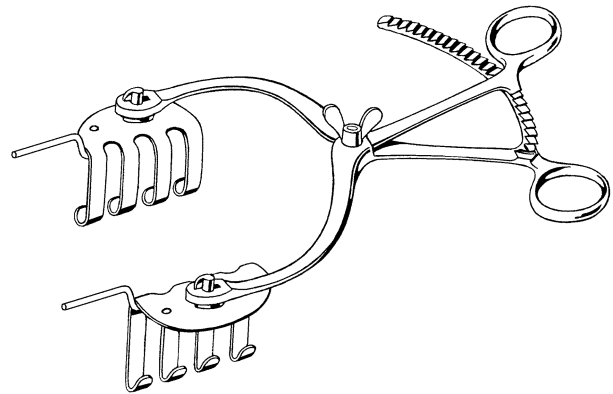

Specula

92350-10 Turner Warwick Dilating Posterior Urethral Speculum, with fibrelight, adult

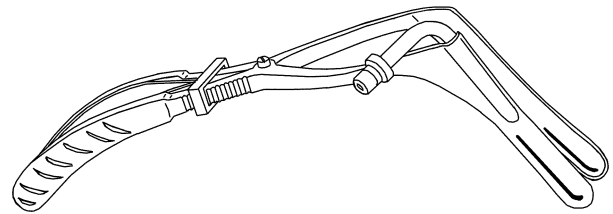

92360-10 Turner Warwick Review Speculum, with fibrelight, child or revision

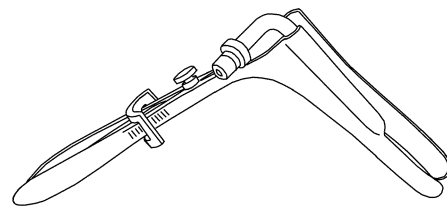

Stone Forceps

92400-10 Randall Renal Calculus Stone Forcep, screw joint, fenestrated jaw, shape A, 230mm



92400-20 Randall Renal Calculus Stone Forcep, screw joint, fenestrated jaw, shape B, 210mm

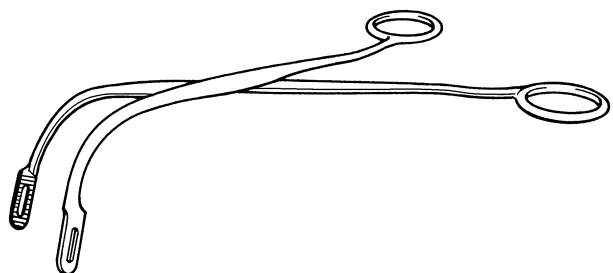

# Urology

## Stone Forceps

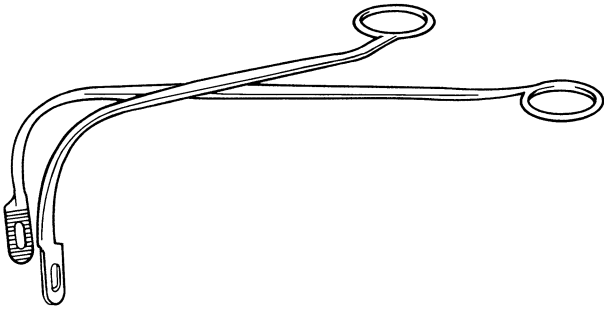

**92400-30** Randall Renal Calculus Stone Forcep, screw joint, fenestrated jaw, shape C, 195mm

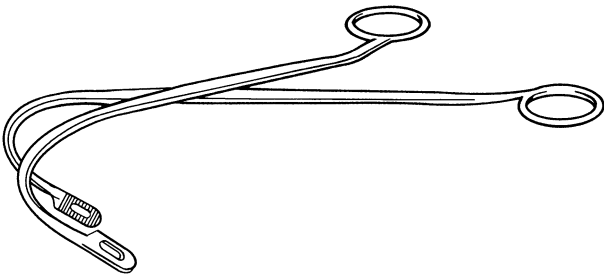

**92400-40** Randall Renal Calculus Stone Forcep, screw joint, fenestrated jaw, shape D, 180mm

## Suction Tubes

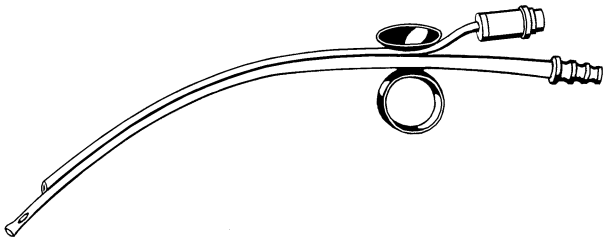

**92450-10** Turner Warwick Suction Tube, s/s, with fibre light, curved with finger control

**95000-10** Langs Lachrymal Cannula, long curve



**95010-10** Langs Lachrymal Cannula, short curve



## Eye Probes

**96180-10** Bowman Lachrymal Probe, bulbous end, s/s, 110mm, 00/0 (0.9mm/1.0mm)

**96180-20** Bowman Lachrymal Probe, bulbous end, s/s, 110mm, 1/2 (1.1mm/1.2mm)

**96180-30** Bowman Lachrymal Probe, bulbous end, s/s, 110mm, 3/4 (1.3mm/1.4mm)

**96180-40** Bowman Lachrymal Probe, bulbous end, s/s, 110mm, 5/6 (1.5mm/1.6mm)

**96180-50** Bowman Lachrymal Probe, bulbous end, s/s, 110mm, 7/8 (1.7mm/1.8mm)

**96180-60** Bowman Lachrymal Probe, bulbous end, s/s, 110mm, 9/10 (1.9mm/2.0mm)

**96180-70** Bowman Lachrymal Probe, case only

**96180-80** Bowman Lachrymal Probe, bulbous end, s/s, 110mm, set of 4 (1/2 - 7/8)

**96180-85** Bowman Lachrymal Probe, bulbous end, s/s, 110mm, set of 4 (1/2 - 7/8) in case

**96180-90** Bowman Lachrymal Probe, bulbous end, s/s, 110mm, set of 6 (00/0 - 9/10)

**96180-95** Bowman Lachrymal Probe, bulbous end, s/s, 110mm, set of 6 (00/0 - 9/10) in case



**96200-04** Liebriech Lachrymal Probe, double ended, silver, size 0000/000 (0.7mm/0.8mm)

**96200-06** Liebriech Lachrymal Probe, double ended, silver, size 00/0 (0.9mm/1.0mm)

**96200-10** Liebriech Lachrymal Probe, double ended, silver, size 1/2 (1.1mm/1.2mm)

**96200-30** Liebriech Lachrymal Probe, double ended, silver, size 3/4 (1.3mm/1.4mm)

**96200-50** Liebriech Lachrymal Probe, double ended, silver, size 5/6 (1.5mm/1.6mm)

**96200-70** Liebriech Lachrymal Probe, double ended, silver, size 7/8 (1.7mm/1.8mm)

**96200-85** Liebriech Lachrymal Probe, double ended, silver, set of 3 (1/2 - 5/6)

**96200-90** Liebriech Lachrymal Probe, double ended, silver, set of 4 (00/0 - 5/6)

**96200-95** Liebriech Lachrymal Probe, double ended, silver, set of 6 (0000/000 - 7/8)



# Ophthalmic

## Eye Scissors

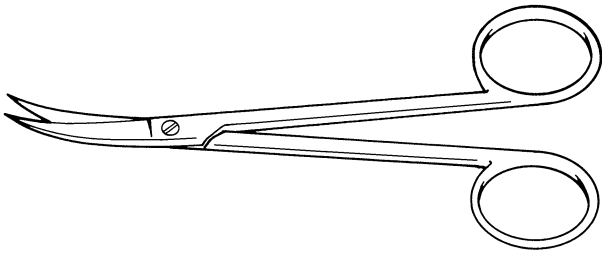

- 96430-09** Iris Scissor, curved, lightweight, sharp, 90mm
- 96430-11** Iris Scissor, curved, lightweight, sharp, 110mm
- 96440-09** Iris Scissor, curved, sharp, 90mm
- 96440-11** Iris Scissor, curved, sharp, 110mm

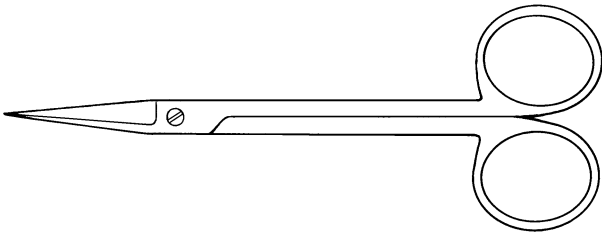

- 96450-09** Iris Scissor, straight, lightweight, sharp, 90mm
- 96450-11** Iris Scissor, straight, lightweight, sharp, 110mm
- 96460-09** Iris Scissor, straight, sharp, 90mm
- 96460-11** Iris Scissor, straight, sharp, 110mm

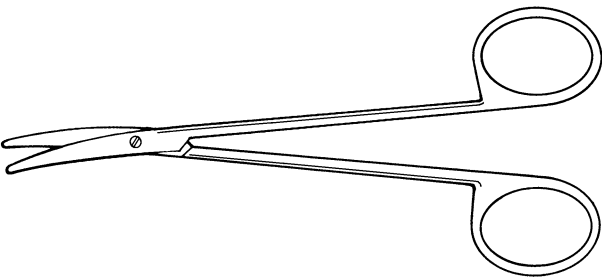

- 96630-09** Strabismus Scissor, curved, blunt, 90mm
- 96630-11** Strabismus Scissor, curved, blunt, 110mm

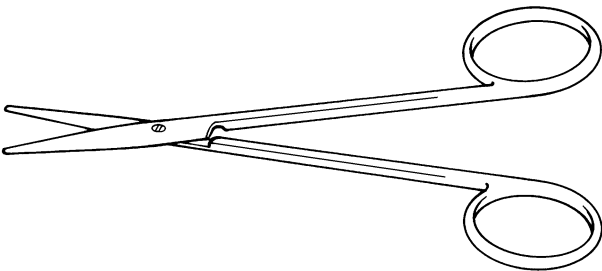

- 96640-09** Strabismus Scissor, straight, blunt, 90mm
- 96640-11** Strabismus Scissor, straight, blunt, 110mm

## Forceps

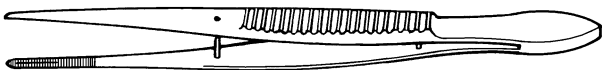

- 96860-10** Moorfield Suture Holding Forcep, serrated, fine points, 100mm

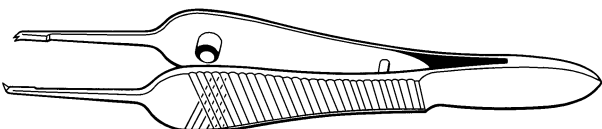

- 96885-08** St.Martin Suturing Forcep, with tying platform, 1/2 teeth, 85mm

## Foreign Body Instruments

**96900-10** Eye Needle And Spud, double ended

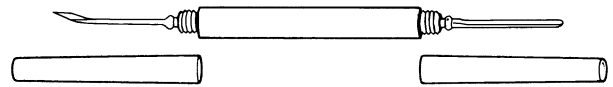

## Lachrymal Dilators

**97100-11** Foster Lachrymal Dilator And Finder, screw on cap, 115mm

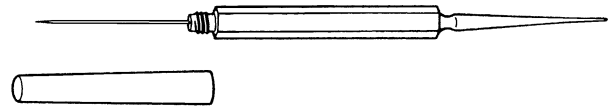

**97110-10** Lang Lachrymal Dilator, conical, 100mm



**97120-10** Nettleship Lachrymal Dilator, conical, 100mm



## Retractors

**97800-30** Watson Orbital Retractor, single blade

**97800-40** Watson Orbital Retractor, large double blade

**97800-50** Watson Orbital Retractor, medium double blade

**97800-60** Watson Orbital Retractor, small double blade

**97800-90** Watson Orbital Retractor, set of 4

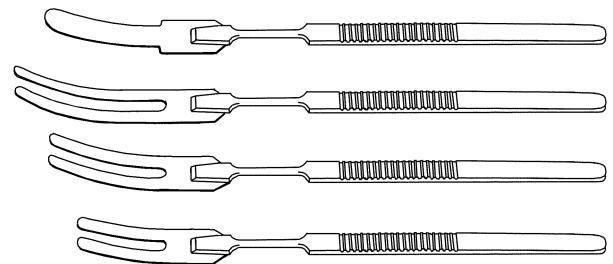

# Operating Table Accessories

## Clamps

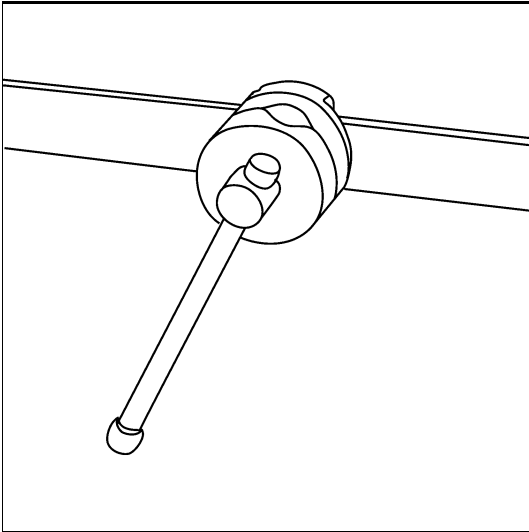

- 99420-10** Rotary Clamp, toothed, to take 16mm (5/8") dia. shaft, to fit 32mm x 6.5mm (1.1/4" x 1/4") bar
- 99430-10** Rotary Clamp, toothed, to take 16mm (5/8") dia. shaft, to fit 25mm x 10mm bar
- 99440-10** Rotary Clamp, toothed, to take 16mm (5/8") dia. shaft or 19mm (3/4") dia. shaft, to fit 28.5mm x 9.5mm (1.1/8" x 3/8") bar
- 99450-10** Rotary Clamp, toothed, to take 16mm (5/8") dia. shaft or 19mm (3/4") dia. shaft, to fit 25mm x 10mm bar
- 99460-10** Rotary Clamp, toothed, to take 16mm (5/8") dia. shaft or 19mm (3/4") dia. shaft, to fit 32mm x 6.5mm (1.1/4" x 1/4") bar

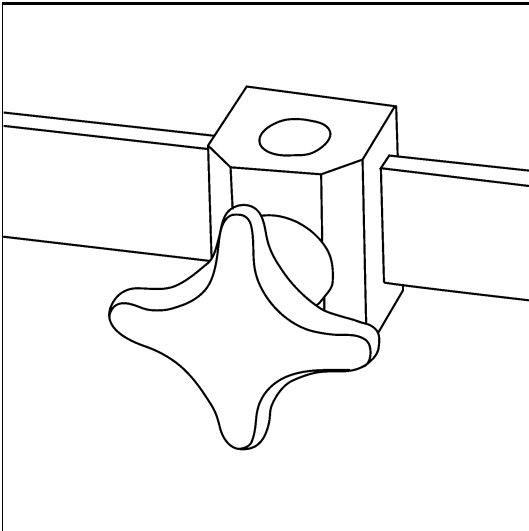

- 99700-10** Plain Clamp, to take 16mm (5/8") dia. shaft, to fit 32mm x 6.5mm (1.1/4" x 1/4") bar, plastic handle
- 99710-10** Plain Clamp, to take 16mm (5/8") dia. shaft, to fit 25mm x 10mm bar, plastic handle

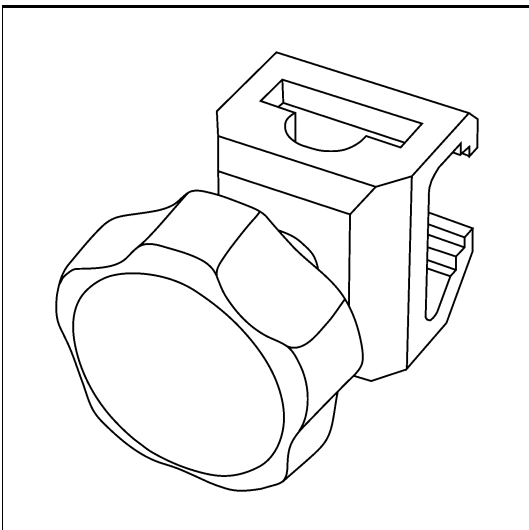

- 99730-10** Plain Clamp, universal, to take 16mm (5/8") dia. shaft or 32mm x 6.5mm (1.1/4" x 1/4") bar, to fit 32mm x 6.5mm (1.1/4" x 1/4") or 25mm x 10mm bar, plastic handle



## Operating Table Accessories

### Clamps

- 99750-10** Plain Clamp, to take 32mm x 6.5mm (1.1/4" x 1/4") bar, to fit 32mm x 6.5mm (1.1/4" x 1/4") bar, plastic handle
- 99760-10** Plain Clamp, to take 32mm x 6.5mm (1.1/4" x 1/4") bar, to fit 25mm x 10mm bar, plastic handle

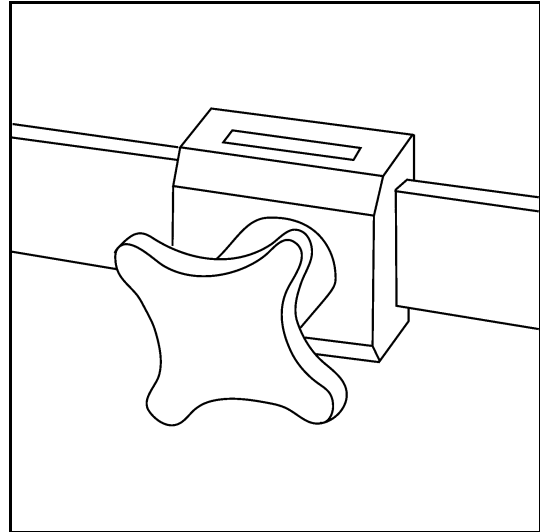

### Instrument Trays

- 99350-10** Perineal Instrument Tray, complete with s/s tray
- 99351-10** Perineal Instrument Tray, Scheerer pins, complete with s/s tray
- 99352-10** Perineal Instrument Tray, Maquet pins, complete with s/s tray
- 99353-10** Perineal Instrument Tray, ALM screw locking pins, complete with s/s tray
- 99355-10** Perineal Instrument Tray, s/s tray only

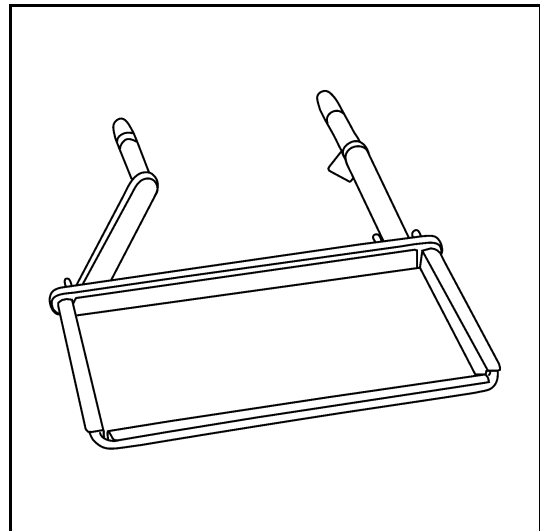

# Operating Table Accessories

## Instrument Trays

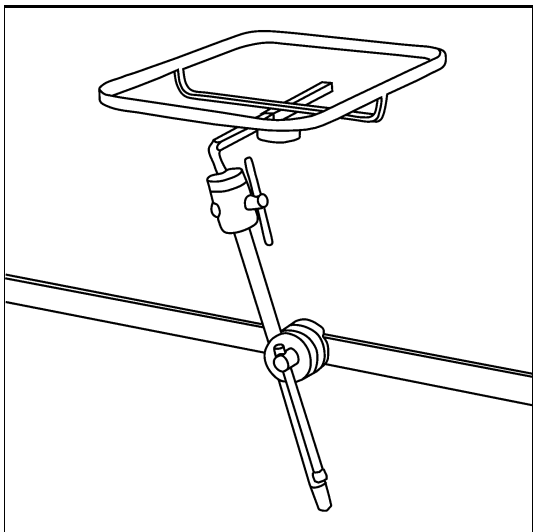

**99365-10** Plain Instrument Tray, complete with s/s tray

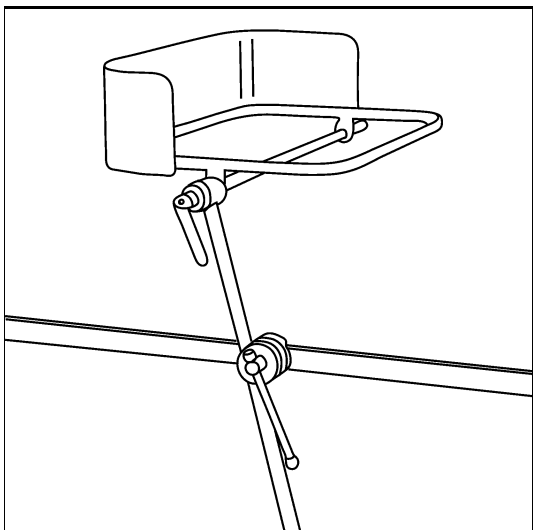

**99380-10** St.Marks Hospital Patten Instrument Tray, complete with s/s tray

- 99050-10** Pelvic Support, standard upright, 135mm, metalwork only
- 99050-20** Pelvic Support, standard upright, 135mm, with anti-static pad
- 99050-30** Pelvic Support, anti-static pad only
- 99051-10** Pelvic Support, extra long upright, 285mm, metalwork only
- 99051-20** Pelvic Support, extra long upright, 285mm, with anti-static pad
- 99055-10** Pelvic Support, drop handle only
- 99055-20** Pelvic Support, sliding bar and pole only
- 99055-30** Pelvic Support, standard upright only, 135mm
- 99055-40** Pelvic Support, extra long upright only, 285mm
- 99055-50** Pelvic Support, bronze washer only

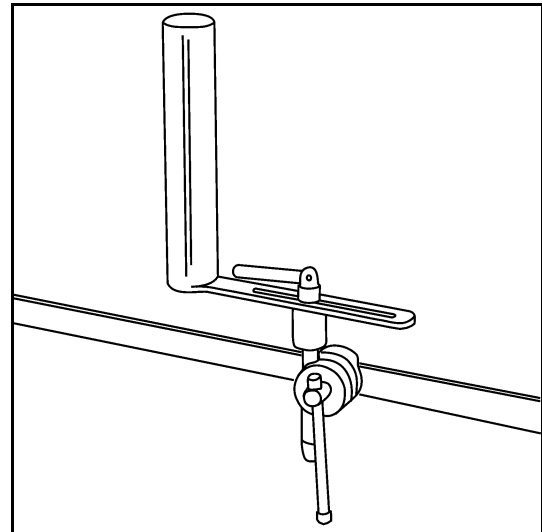

- 
- 99100-10** Tudor Edwards Support, metalwork only
  - 99100-20** Tudor Edwards Support, with anti-static pad
  - 99100-30** Tudor Edwards Support, anti-static pad only

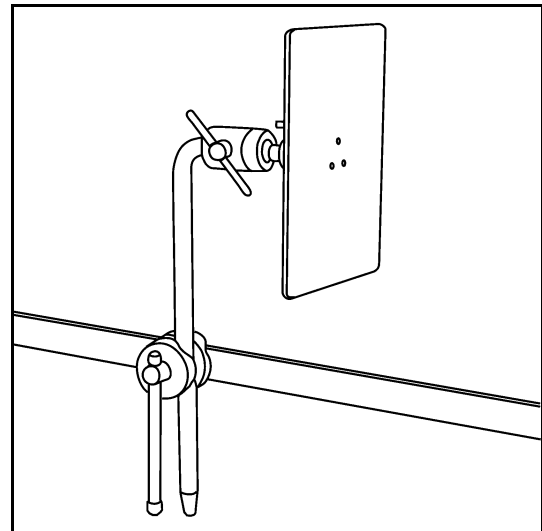

# Operating Table Accessories

## Supports

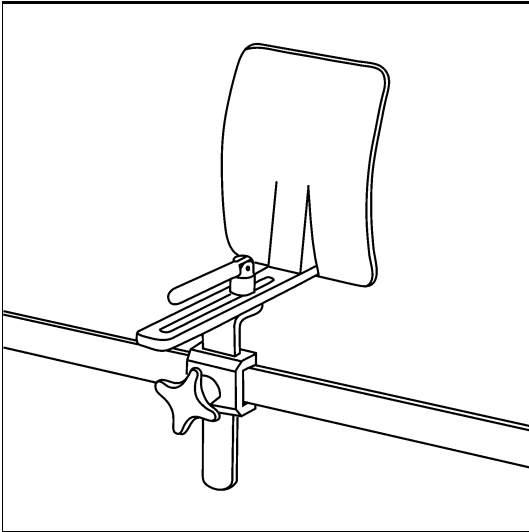

- 99150-10** Lateral Support, adult, short upright, 165mm, metalwork only
- 99150-20** Lateral Support, adult, short upright, 165mm, with anti-static pad
- 99150-30** Lateral Support, adult, anti-static pad only
- 99151-10** Lateral Support, adult, flat plate, short upright, 165mm, metalwork only
- 99151-20** Lateral Support, adult, flat plate, short upright, 165mm, with anti-static pad
- 99160-10** Lateral Support, adult, long upright, 275mm, metalwork only
- 99160-20** Lateral Support, adult, long upright, 275mm, with anti-static pad
- 99161-10** Lateral Support, adult, flat plate, long upright, 275mm, metalwork only
- 99161-20** Lateral Support, adult, flat plate, long upright, 275mm, with anti-static pad
- 99185-10** Lateral Support, drop handle only
- 99185-20** Lateral Support, horizontal arm only
- 99185-30** Lateral Support, adult casting only
- 99185-40** Lateral Support, adult flat plate only
- 99185-70** Lateral Support, short upright only, 165mm

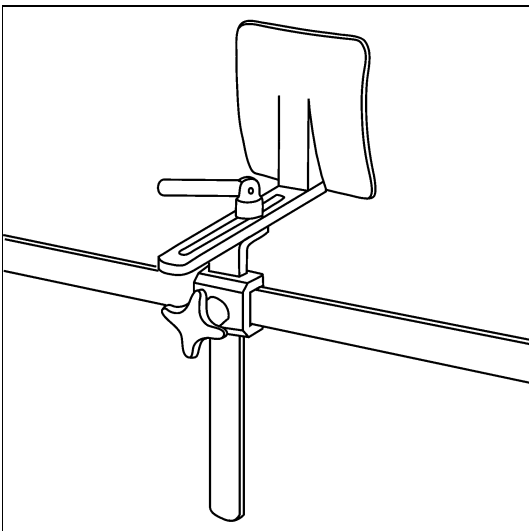

- 99170-10** Lateral Support, child, short upright, 165mm, metalwork only
- 99170-20** Lateral Support, child, short upright, 165mm, with anti-static pad
- 99170-30** Lateral Support, child, anti-static pad only
- 99171-10** Lateral Support, child, flat plate, short upright, 165mm, metalwork only
- 99171-20** Lateral Support, child, flat plate, short upright, 165mm, with anti-static pad
- 99180-10** Lateral Support, child, long upright, 275mm, metalwork only
- 99180-20** Lateral Support, child, long upright, 275mm, with anti-static pad
- 99181-10** Lateral Support, child, flat plate, long upright, 275mm, metalwork only
- 99181-20** Lateral Support, child, flat plate, long upright, 275mm, with anti-static pad
- 99185-50** Lateral Support, child casting only
- 99185-60** Lateral Support, child flat plate only
- 99185-80** Lateral Support, long upright only, 275mm

- 99200-10** Carter Braine Arm Support, adult, 215mm long gutter, metalwork only
- 99200-20** Carter Braine Arm Support, adult, 215mm long gutter, with anti-static pad
- 99200-30** Carter Braine Arm Support, adult, 215mm long gutter, anti-static pad only

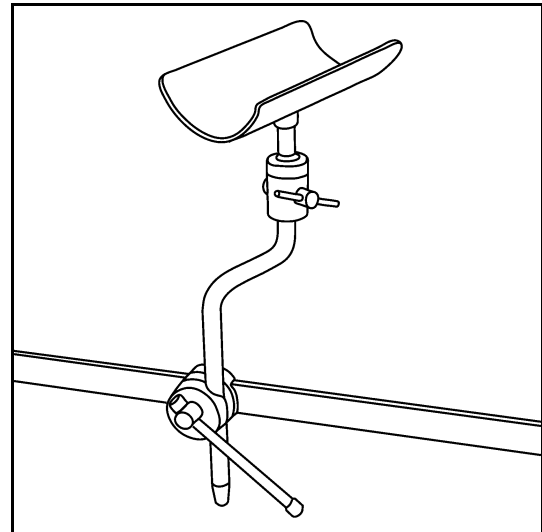

- 99220-10** Carter Braine Arm Support, modified for elbow surgery, 150mm long gutter, adult, metalwork only
- 99220-20** Carter Braine Arm Support, modified for elbow surgery, 150mm long gutter, adult, with anti-static pad
- 99220-30** Carter Braine Arm Support, modified for elbow surgery, 150mm long gutter, adult, anti-static pad only

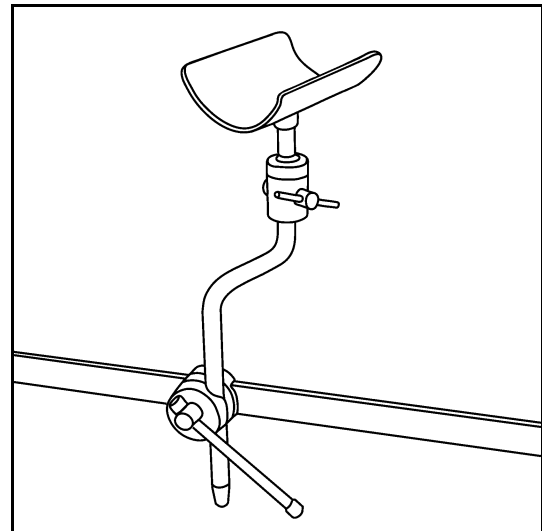

- 99250-10** Lithotomy Stirrups, pair, metalwork only
- 99250-20** Lithotomy Stirrups, pair, with anti-static pads
- 99250-30** Lithotomy Stirrups, pair, anti-static pads only
- 99250-40** Lithotomy Stirrups, pair, canvas slings only

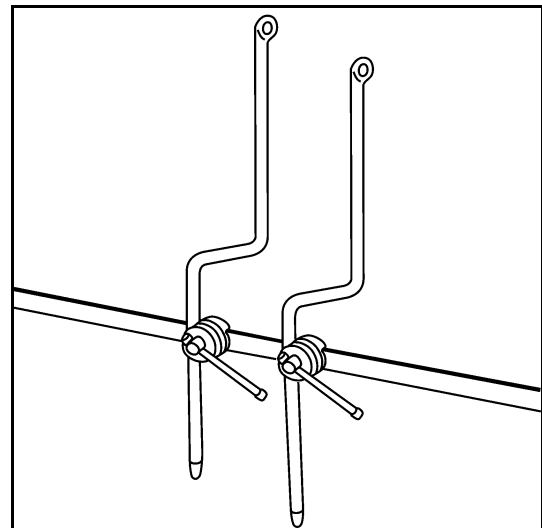

# Operating Table Accessories

## Supports

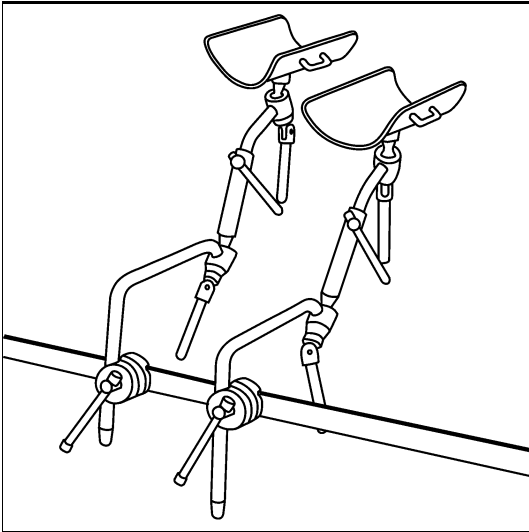

- 99300-10** Lloyd Davis Lithotomy Crutch, pair, metalwork only
- 99300-20** Lloyd Davis Lithotomy Crutch, pair, with anti-static pads
- 99300-30** Lloyd Davis Lithotomy Crutch, pair, anti-static pads only
- 99305-10** Lloyd Davis Lithotomy Crutch, extension tube screw and tommy bar only
- 99305-20** Lloyd Davis Lithotomy Crutch, extension tube only
- 99305-30** Lloyd Davis Lithotomy Crutch, gutter casting only, left
- 99305-40** Lloyd Davis Lithotomy Crutch, gutter casting only, right
- 99305-50** Lloyd Davis Lithotomy Crutch, upper ball joint and gutter only, left
- 99305-60** Lloyd Davis Lithotomy Crutch, upper ball joint and gutter only, right

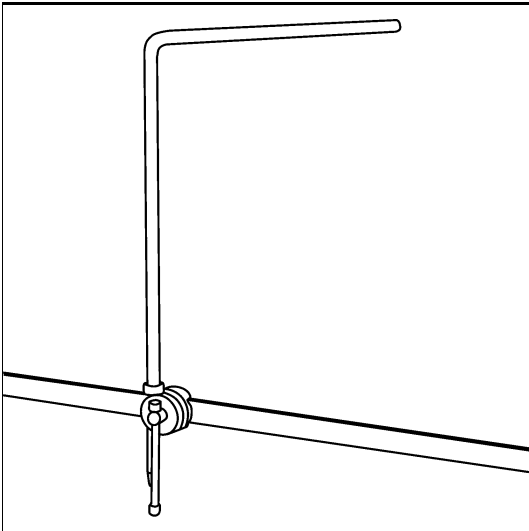

- 99500-10** Anaesthetic Screen, single, metalwork only
- 99500-20** Anaesthetic Screen, single, with anti-static pad
- 99500-30** Anaesthetic Screen, single, anti-static pad only

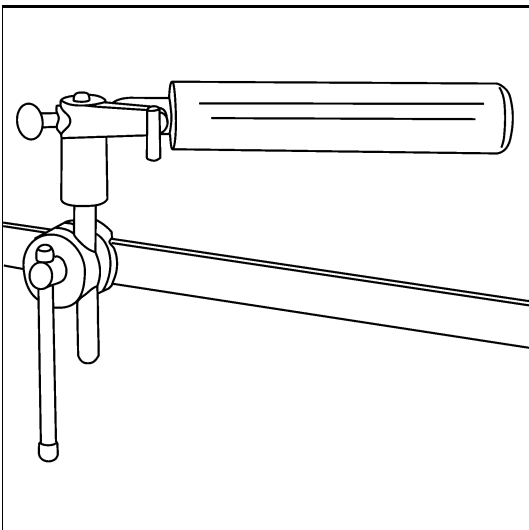

- 99600-10** Buttock Support, metalwork only
- 99600-20** Buttock Support, with anti-static pad
- 99600-30** Buttock Support, anti-static pad only

- 99650-10** Wilson Frame, metalwork only
- 99650-20** Wilson Frame, with anti-static pads
- 99650-30** Wilson Frame, anti-static pads only

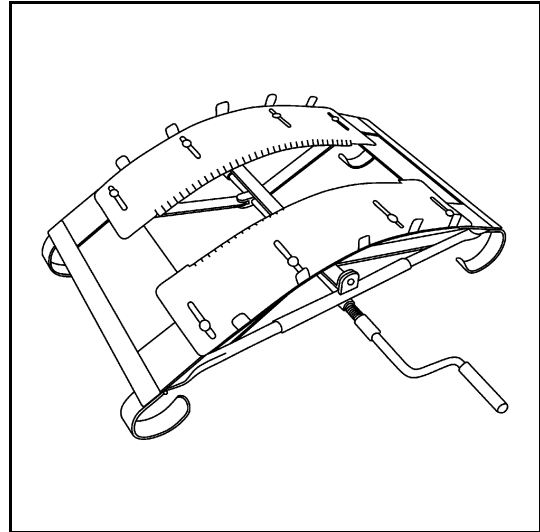

- 99800-10** Knee Crutch, pair, metalwork only
- 99800-20** Knee Crutch, pair, with anti-static pads
- 99800-30** Knee Crutch, pair, anti-static pads only

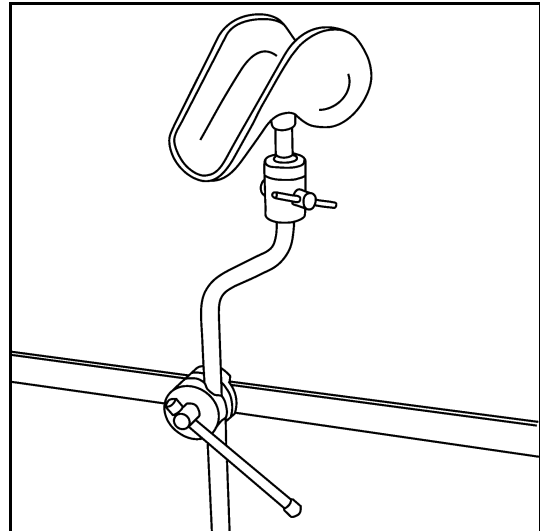





## Index - Alphabetical

### A

Abel Rectal Speculum	261
Abrams Pleural Biopsy Punch	170
Adaptors	110
Addison Urethral Bougie	266
Adson (Fraser) Artery Forcep	1
Adson Dissecting Forcep	14
Adson Dissecting Forcep	240
Adson Dural Hook	241
Adson Frazier Suction Tube	254
Adson Periosteal Elevator	242
Adson Suction Tube	254
Agnew Myringotome	146
Alar Cartilage Scissor	104
Albee Bone Caliper	202
Alexander Mastoid Gouge	205
Allis (American Pattern) Tissue Forcep	72
Allis Tissue Forcep	73
Allison Lung Retractor	180
Alveolar-Pernasal Wiring Awl	78
Alveolectomy File	83
American Pattern Insulated Suction Tube	70
American Pattern Suction Tube	70
American Spinal Curette	239
Amputation Saw	56
Anaesthetic Screen	288
Anderson Tunnelling Forcep	219
Anel Silver Probe	230
Aneurysm Needle	27
Angell James Palate Lever	154
Angell James Punch Forcep	155
Anvil For Hand Surgery	109
Archimedean Hand Drill	84
Artery Forceps	1
Artery Forceps	110
Artery Forceps	170
Artery Forceps	236
Arthur Splinter Forcep	69
Asch Septum Forcep	104
Ascites Trocar	75
Aspirating Tube	134
Attwood Retractor	92
Aufrecht Dissecting Scissor	57
Aufrecht Retractor	157
Aural Dressing Forceps	112
Aural Forceps	113
Aural Instruments	118
Aural Snares	127
Aural Specula	128
Awls	78
Awty Osteotomy Retractor	92

### B

Babcock Tissue Forcep	73
Backhaus Towel Clip	74
Bacon Aural Syringe	165
Bailey Rib Spreader	183
Bailey Vaginal Speculum	234
Bake Bile Duct Dilator	13
Balfour Self Retaining Retractor	41

Ballenger Nasal Knife	149
Bankhart Bone Lever	201
Barnes Episiotomy Scissor	232
Barnes Obstetric Forcep	229
Barnhill Curette	136
Barron Haemorrhoid Ligator	259
Barron Scalpel Handle	103
Barron Suction Tube	161
Barsky Double Skin Hook	106
Barsky Glabella Rasp	91
Barsky Nasal Rasp	91
Bateman Pituitary Forcep	154
Bateman Rongeur	247
Bateman Suture Pusher	108
Baylor Sump Sucker	174
Beales Aural Forcep	113
Beales Platinectomy Instruments	118
Beales Tympanoplasty Instruments	119
Beavis Dissector	138
Beckmann Curette	136
Belluci Suction Tube	161
Bennett 'Cobra' Bone Lever	201
Bentall Femoral Cannula	174
Berkeley Abdominal Self Retaining Retractor	42
Berkeley-Bonney Clamp	223
Bickford Dissecting Forcep	14
Biopsy Forceps	131
Biopsy Forceps	257
Biopsy Punches	170
Bipods	132
Birkett Artery Forcep	110
Blackburn Traction Apparatus	254
Blake Amputation Flap Retractor	30
Blalock Clamp	170
Blalock Hook	173
Blanco Valve Leaflet Retractor	180
Blandy Modified Gil Vernet Retractor	275
Block End Dissecting Forcep	14
Blount Staple Driver	217
Blount Staple Remover	217
Blount Staple Set	217
Blount Staple Starter	218
Bodenham Dermabrasion Cylinder	81
Bohler Bender	28
Bohler Stirrup	218
Bone Awls	196
Bone Crusher	133
Bone Curettes	196
Bone Cutting Forceps	198
Bone Holding Clamps	199
Bone Holding Forceps	199
Bone Hooks	200
Bone Instruments	133
Bone Levers	201
Bone Pin Chuck	220
Bonney Barker Dilator	226
Bonney Clamp	223
Bonney Dissecting Forcep	15
Bonney Polypus Uterine Forcep	234
Bonney Reverdin Needle	27
Bougies	266
Bowdler-Henry Rake Retractor	92

## Index - Alphabetical

Bowman Lachrymal Probe	279
Bozemann Needleholder	21
Bozemann Uterine Dressing Forcep	228
Braces	238
Brain Knife	20
Braithwaite Chisel	78
Braithwaite Dissecting Forcep	15
Braithwaite Skin Graft Knife	106
Brand Plantaris Stripper	219
Braun-Stadler Episiotomy Scissor	232
Bristow Maler Elevator	81
Bristow Periosteal Elevator	204
Brock Cardiac Sound	192
Brock Erector Spinae Retractor	180
Brodie Director	13
Brompton Erector Spinae Retractor	180
Brompton Hospital Suction Tube	193
Bronchoscopes	134
Broomhead Psoas Retractor	31
Bruns / Bohler Plaster Shears	28
Brushes	7
Bryant Dressing Forcep	18
Buck Curette	136
Burford Rib spreader	183
Burns Bone Holding Forcep	199
Burs	134
Burs	202
Burs	238
Buttock Support	288

### C

Cairns Artery Forcep	236
Cairns Dissecting Forcep	240
Cairns Dressing Forcep	241
Cairns Dural Guide And Director	243
Cairns Dural Hook	241
Cairns Scalp Self Retaining Retractor	245
Cairns Scissor	253
Cairns Strip Retractor	244
Calipers	202
Campbell Suture Scissor	104
Canadian Dissecting Forcep	15
Cannulae	135
Cannulae	222
Cannulae	238
Cannulae	279
Canny Ryall Army Retractor	31
Canny Ryall Meatal Bougie	266
Canny Ryall Navy Retractor	31
Capener Chisel	203
Capener Gouge	243
Capener Lamina Gouge	243
Capener Osteotome	209
Capener Reverse Blade Gouge	243
Carless Scissor	57
Carter Braine Arm Support	287
Cartilage Knife	20
Carton-Cowell Catheter	222
Catheter Introducers	272
Catheters	135
Catheters	222

Cawthorne Aural Forcep	113
Cawthorne Aural Instruments	120
Cawthorne Cerumen Hook	135
Cawthorne Nasal Forcep	146
Cawthorne Scissor	159
Cerumen Hooks	135
Charnley Bone Awl	196
Charnley Bone Curette	196
Charnley Compression Clamp	204
Charnley Gouge	205
Charnley Horizontal Self Retaining Retractor	214
Charnley Initial Incision Retractor	212
Charnley Knee Retractor	212
Charnley Laminectomy Retractor	244
Charnley Pin Retractor	212
Charnley Screw Jack	217
Charnley Suture Forcep	219
Charnley Wire Passer	220
Cheatele Steriliser Forcep	70
Chevalier Jackson Biopsy Forcep	131
Chevalier Jackson Laryngeal Grasping Forcep	141
Chevalier Jackson Vocal Nodule Forcep	153
Chisels	78
Chisels	203
Cholecystectomy Forceps	7
Cinco Suction Tube	174
Cinelli Osteotome	88
Circumcision Shields	273
Citelli Antrum Punch Forcep	155
Clamps	8
Clamps	170
Clamps	223
Clamps	257
Clamps	273
Clamps	282
Clamps - Atraumatic	10
Clamps - Atraumatic	225
Clamps - Atraumatic	257
Clamps - Atraumatic	274
Clarke Bile Duct Dilator	13
Cleft Palate Raspatory	90
Cleland Self Retaining Retractor	42
Clip Forceps	11
Clip Forceps	239
Clutton Urethral Bougie	267
Cobb Elevator	242
Cobbett Skin Graft Knife	106
Cocanising Wires	136
Collar Crushing Forceps	80
Collin Self Retaining Retractor	43
Collin Tongue Forcep	166
Collingwood Stewart Hernia Forcep	19
Collins Rib Spreader	183
Compression Clamps	204
Comyns Berkeley Clip Forcep	11
Conchotomes	136
Cone Self Retaining Retractor	245
Cone Ventricular Cannula	238
Cones Traction Tong	255
Continental Pattern Dissecting Forcep	15
Converse Retractor	93
Cooley Atrial Retractor	180

## Index - Alphabetical

<b>Cooper Needle</b>	27
Costotomes	172
<b>Cottle Alar Protector</b>	147
<b>Cottle Elevator</b>	139
<b>Cottle Mallet</b>	207
<b>Cottle Nasal Chisel</b>	78
<b>Cottle Nasal Speculum</b>	150
<b>Cottle Nievert Retractor</b>	157
<b>Cottle Periosteal Comb And Spicule Sweeper</b>	147
<b>Cottle Retractor</b>	157
<b>Cottle Retractor</b>	158
<b>Cottle Tenaculum Hook</b>	147
<b>Cottle Upper Lateral Exposing Retractor</b>	93
<b>Cottle Upper Lateral Exposing Retractor</b>	158
<b>Coupland Gouge</b>	83
<b>Crafoord Clamp</b>	170
<b>Crile Artery Forcep</b>	236
<b>Crile Wood Needleholder</b>	21
<b>Crile Wood Needleholder - Tungsten Carbide</b>	24
<b>Crile-Murray Needleholder</b>	21
<b>Crutchfield Traction Tong</b>	255
<b>Cryer Exolever</b>	81
Curettes	80
Curettes	136
Curettes	225
Curettes	239
<b>Cushing Artery Forcep</b>	237
<b>Cushing Pituitary Rongeur</b>	247
<b>Cushing Retractor</b>	244
<b>Cushing Rongeur</b>	247
<b>Czerny Retractor</b>	31

### D

<b>Davis-Boyle Gag Frame</b>	143
<b>Davis-Boyle Gag Frame Pad</b>	143
<b>Davis-Boyle Tongue Plate</b>	143
<b>De Martel Anastomosis Clamp</b>	8
<b>De Martel Saw Guide</b>	252
<b>Deaver Abdominal Retractor</b>	31
<b>DeBakey Atraumatic Tissue Forcep</b>	194
<b>DeBakey Hysterectomy Atraumatic Clamp</b>	225
<b>DeBakey Needleholder - Tungsten Carbide</b>	25
<b>DeBakey Vascular Dilator</b>	172
<b>DeBakey-Balfour Self Retaining Retractor</b>	43
<b>DeBakey-Dietrich Clamp</b>	171
Decompressors	12
<b>Denis Brown Intestinal Forcep</b>	19
<b>Denis Browne Collar Crushing Forcep</b>	80
<b>Denis Browne Self Retaining Retractor</b>	43
<b>Denis Browne Tonsil Holding Forcep</b>	167
<b>Dental Chip Syringe</b>	108
Depressors	12
<b>Derf Needleholder</b>	21
<b>Derf Needleholder - Tungsten Carbide</b>	25
Dermabrasion Cylinders	81
<b>Deschamps Needle</b>	27
<b>Desmarres Retractor</b>	93
Diathermy Instruments	12
<b>Diathermy Quiver</b>	12
<b>Dieffenbach Artery Forcep</b>	1
<b>Dietrich Micro Bulldog Clamp</b>	171

Dilators	13
Dilators	172
Dilators	226
Dilators	258
Dilators	274
<b>Dingman Gag Frame</b>	144
<b>Dingman Tongue Plate</b>	144
Directors	13
Directors	258
Dislocating Hooks	204
Dissecting Forceps	14
Dissecting Forceps	81
Dissecting Forceps	172
Dissecting Forceps	204
Dissecting Forceps	240
Dissecting Forceps	258
Dissecting Forceps	274
Dissectors	18
Dissectors	138
Dissectors	241
<b>Dott Dissecting Forcep</b>	240
<b>Doughty Tongue Plate</b>	144
<b>Doyen (Pozzi) Retractor</b>	231
<b>Doyen Atraumatic Clamp</b>	10
<b>Doyen Intestinal Clamp</b>	8
<b>Doyen Mouth Gag</b>	144
<b>Doyen Myoma Screw</b>	228
<b>Doyen Periosteal Elevator</b>	173
<b>Doyen Retractor</b>	32
<b>Doyen Retractor</b>	231
<b>Doyen Scissor</b>	57
<b>Draffin Bipod</b>	132
Dressing Forceps	18
Dressing Forceps	228
Dressing Forceps	241
<b>Dressing Scissor</b>	57
<b>Dressing Scissor - Tungsten Carbide</b>	65
<b>Dressing Scissor - Ultra Cutting</b>	67
<b>Duncan Walker Rib Spreader</b>	184
<b>Dundas-Grant Seeker</b>	161
<b>Dunhill Artery Forcep</b>	1
<b>Dupuytren Needle</b>	28
Dural Hooks	241
<b>Durham Dissector</b>	18
<b>Durham Retractor</b>	32
<b>Duval Lung Forcep</b>	173
<b>Duval Tissue Forcep</b>	73
<b>Dyball And Lock Retractor</b>	33
<b>Dyson Retractor</b>	33

### E

<b>Eastman Dental Chisel</b>	79
<b>Eckhoff Mapping Pen</b>	85
<b>Eddy Parotid Retractor</b>	93
<b>Eisenhammer Anal Self Retaining Retractor</b>	262
Elevators	81
Elevators	139
Elevators	173
Elevators	204
Elevators	242
<b>Elliot Iris Scissor</b>	59

## Index - Alphabetical

Emmett Dissecting Forcep	15
Engels Plaster Saw	56
Eppendorf Biopsy Punch	230
Eve Tonsil Snare	167
Exner Curette	80
Extractors	205
Eye Needle And Spud	281
Eye Probes	279
Eye Scissors	280

### F

Falconer Rongeur	248
Fansler Operating Proctoscope	260
Farabeuf Rugine	216
Faure Clamp	224
Felming Bone Graft Punch	211
Female Catheter	223
Ferguson Mouth Gag	20
Fergusson Bone Holding Forcep	199
Fergusson Scissor	59
Fergusson Suction Tube	162
Ferris Smith Punch Forcep	155
Fickling Dental Mallet	84
Fickling Oral Forcep	87
Files	83
Files	205
Finch Excision Atraumatic Clamp	257
Finochietto Needleholder - Tungsten Carbide	25
Finochietto Rib Spreader	184
Fitzpatrick Mandibular 'Trowel' Retractor	93
Fitzpatrick Tongue Guard Retractor	94
Foerster Sponge Holding Forcep	70
Foley Catheter Introducer	272
Fomon Chisel	79
Forceps	280
Foreign Body Instruments	281
Formby Cerumen Hook	135
Formby Suction Tube	163
Foster Gillies Needleholder	86
Foster Gillies Needleholder - Tungsten Carbide	87
Foster Lachrymal Dilator And Finder	281
Fraser Kelly Artery Forcep	1
Fraser Wilkinson Intra Uterine Cannula	222
Frazier Suction Tube	254
Freeman Face Lift Retractor	94
Freer Elevator	139
Freer Nasal Chisel	148
Freer Nasal Elevator	148
Freer Nasal Knife	148
Freer Nasal Separator And Elevator	148
French (Gillies) Osteotome	88
French Bow Dressing Forcep	18
French Chisel	203
Frenchay Chisel	79
Frenchay Towel Clip	75
Fuller Aural Forcep	113
Furlong Tendon Stripper	219

### G

Gabarro Skin Graft Measurer	105
-----------------------------	-----

Galabin Uterine Sound	233
Galvao Nipple Marker	85
Gardiner Brown Imray Loop And Hook	141
Geary-Grant Cholecystectomy Forcep	7
Gibson-Ross Skin Graft Board	105
Giertz Rib Shear	182
Gigli Saw	252
Gil Vernet Retractor	275
Gillies Dissecting Forcep	16
Gillies Needleholder	87
Gillies Needleholder - Tungsten Carbide	87
Gillies Skin Hook	107
Gillies Suction Tube	234
Glasgow Rongeur	249
Glasgow Scissor	59
Glegg Aural Snare	127
Glegg Nasal Snare	150
Goligher Scissor	263
Goligher Self Retaining Retractor	46
Goligher Sternal Lifting Retractor	192
Goodwin Amniotomy Peritoneum Forcep	230
Goosen Aorta Punch	178
Gordon Skin Hook	107
Gorgetts	274
GOSH Cannula	174
GOSH Modified Pacifico Cannula	175
GOSH Modified Pacifico Cannula	175
GOSH Suction Tube	175
GOSH Suction Tube	176
GOSH Ventricular Vent	176
Gossett Panting Self Retaining Retractor	46
Gossett Self Retaining Retractor	46
Gouges	83
Gouges	139
Gouges	205
Gouges	243
Graves Myers Vein Stripper	76
Green Armytage Peritoneum Forcep	230
Grey Turner Artery Forcep	1
Gruber Aural Speculum	128
Grunwald Turbinate Forcep	168
Guard For Parker Kerr Clamp	8
Guides	243
Guilford Wright Curette	137
Guyon Catheter Introducer	273
Guys Gouge	139
Guys Plaster Shears	29
Guys Suture Forcep	72
Guys Tongue Forcep	74
Gwilliam Clamp	224
Gwynne Evans Dissector	138

### H

Haemorrhoid Ligators	259
Hajeck Antrum Punch Forcep	156
Hajeck Retractor	94
Hajeck Sphenoidal Punch Forcep	156
Hallpike Myringotome	146
Hallpike Ring Curette	137
Halsey Needleholder	22
Halsey Needleholder - Tungsten Carbide	25

## Index - Alphabetical

Halstead Mosquito Artery Forcep	2
Hammer For Hand Surgery	84
Hand Drills	84
Hand Splints	206
Hardman Laminectomy Self Retaining Retractor	245
Harlow Wood Tendon Hook	219
Harris Bone Curette	197
Harrison Bone Hook	200
Harrison Nicholl Reamer	92
Harrison Tendon Hook	84
Hartmann Aural Dressing Forcep	112
Hartmann Aural Forcep	113
Hartmann Cerumen Hook	135
Hartmann Conchotome	136
Hartmann Nasal Forcep	147
Harvey-Jackson Self Retaining Retractor	246
Hawkin Ambler Dilator	227
Hayes Atraumatic Clamp	257
Hayes-Provis Intra Uterine Cannula	222
Hayton Williams Wire Forcep	109
Heaney Clamp	224
Heath Aural Speculum	128
Heath Mallet	207
Heath Wool carrier	169
Heaths Stitch Scissor	59
Hedley Brown Retractor	181
Hegar Dilator	227
Hegar Needleholder	22
Heiss Artery Forcep	2
Henckel Aural Forcep	115
Henderson Self Retaining Retractor	246
Henderson Stripping Retractor	94
Hennig Spreader	29
Hernia Forceps	19
Herrick Kidney Pedicle Atraumatic Clamp	274
Hey Groves Bone Holding Forcep	199
Hey Groves Retrograde Bougie	267
Hibbs Retractor	244
Hill Elevator	139
Hohmann-Muller Spike Retractor	213
Hohn Vessel Dilator	172
Hooks	84
Hooks	173
Horrocks Curette	225
Horrocks Uterine Sound	233
Horsley Bone Cutting Forcep	198
Horsley Dura Mater Elevator	242
Hough Aural Forcep	115
Hough Aural Instruments	121
House Curette	137
House Cut-Out Adaptor	110
House Measuring Rod	148
House Suction Tube	163
House-Dieter Aural Forcep	116
Howarth Elevator	82
Hudson Brace	238
Hudson Conical Bur	238
Hudson Perforator	238
Hudson Spherical Burr	238
Hughes Stapes Mobiliser	149
Humby Double Skin Hook	107
Humby Skin Graft Knife	106

Hunter Splinter Forcep	69
Hurd Dissector	138
Hurren Retractor	95
Hydrocele Trocar	75

### I

Iliac Cannula	176
IMA Rib Spreader	185
Imray Loop	141
Infusion Devices	173
Instrument Pins	19
Instrument Trays	283
Insufflators	140
Intestinal Forceps	19
Intra Oral Vertical Osteotomy Retractor	95
Introducers	228
Introducing Forceps	19
Iris Scissor	280
Iris Scissor - Tungsten Carbide	65
Iris Scissor - Ultra Cutting	67
Inside Aural Instruments	122
Irwin Moore Laryngeal Forcep	141
Irwin Moore Turbinate Forcep	168
Irwin Self Retaining Retractor	47

### J

Jackson Burrows Dissecting Forcep	204
Jackson Burrows Retractor	213
Jackson Burrows Self Retaining Retractor	214
Jamieson Mallet	207
Jansen Rongeur	215
Jansen Rongeur	249
Jansen-Middleton Septum Forcep	105
Jayes Osteotome	88
Jeans Dissecting Forcep	16
Jefferson Dissecting Forcep	240
Jefferson Dressing Forcep	241
Jefferson Self Retaining Retractor	246
Jefferson Ventricular Cannula	239
Jenkins Chisel	79
Jenkins Gouge	140
Jewish Pattern Circumcision Shield	273
Jobson Horne Probe	154
Jolls Aneurysm Needle	28
Jolls Thyroid Retractor	33
Jolls Thyroid Self Retaining Retractor	47
Jones Rugine	216
Joseph Nasal Raspatory	91
Joseph Nasal Saw	86
JS Stark Crooked Vent	176
JS Venous Cannula	177
Judd-Allis Tissue Forcep	73

### K

Kay Austin Retractor	95
Kelly Proctoscope	259
Kelly Rectal Speculum	261
Kelly Retractor	34
Kelly-Crile Artery Forcep	2

## Index - Alphabetical

Kelsey Fry Bone Awl	78
Kerrison Rongeur	250
Key Hernia Director	13
Kidd Urethral Bougie	268
Kielland Obstetric Forcep	229
Killian Gouge	140
Killian Nasal Speculum	151
Kilner Alae Retractor	95
Kilner Artery Forcep	3
Kilner Cheek Retractor	96
Kilner Detachable Skin Hook	107
Kilner Dott Gag Frame	145
Kilner Dott Gag Frame	145
Kilner Dott Tongue Plate	145
Kilner Dott Tongue Plate	145
Kilner Malar Elevator	82
Kilner Nasal Retractor	96
Kilner Needleholder	22
Kilner Needleholder - Tungsten Carbide	26
Kilner Retractor	95
Kilner Scissor	104
Kilner Scissor - Ultra Cutting	67
Kilner Skin Retractor	96
Kilner Suction Tube	108
Kings College Hospital Cocanising Wire	136
Kirschner Wire Cutter / Plier	221
Knee Crutch	289
Knight (Heymann) Scissor	159
Knives	20
Knives	206
Knot Tier and Pushers	140
Kocher Artery Forcep	3
Kocher Bone Hook	200
Kocher Intestinal Clamp	8
Kocher Thyroid Dissector	18
Kocher Thyroid Retractor	34
Kuntscher Nail Extractor	208

### L

Lace Self Retaining Retractor	47
Lachrymal Dilators	281
Lack Tongue Depressor	166
Lahey Cholecystectomy Forcep	7
Lambotte Mini Osteotome	210
Landon Vaginal Retractor	231
Lane Bone Lever	201
Lane Intestinal Clamp	9
Lane Plate Bender	210
Lane Retractor	34
Lane Screw Holding Forcep	216
Lane Screwdriver	217
Lane Twin Clamp	9
Lanes Dissecting Forcep	16
Lanes Dissecting Forcep	81
Lanes Tissue Forcep	74
Lang Lachrymal Dilator	281
Lang Stevenson Clamp	9
Langenbeck Bone Hook	200
Langenbeck Retractor	35
Langs Lachrymal Cannula	279
Laryngeal Forceps	141

Laryngeal Instruments	141
Laryngeal Mirror	141
Laryngeal Suction Tube	141
Laster Cheek Retractor	98
Lateral Support	286
Lawrance Needleholder	22
Lawrance Needleholder - Tungsten Carbide	26
Lawrie Extension	71
Lead Hand Splint	206
Leech Wilkinson Biopsy Punch	230
Leech Wilkinson Cannula	222
Leedham Green Dissecting Forcep	16
Leksell Rongeur	215
Lempert Nibbling Forcep	153
Lempert Rongeur	215
Lempert Rugine	158
Lempert Scoop	161
Lempert Suction Tube	163
Lewer Vulsellum Forcep	235
Liebrich Lachrymal Probe	279
Lister Sinus Forcep	69
Lister Urethral Bougie	269
Listers Bandage Scissor	60
Listers Eccentric Scissor	60
Liston Amputation Knife	20
Liston Bone Cutting Forcep	198
Lithotomy Stirrups	287
Littauer Scissor	60
Littlewood Tissue Forcep	74
Lloyd Davis Lithotomy Crutch	288
Lloyd Davis Proctoscope	260
Lloyd Davis Sigmoidoscope Biopsy Forcep	257
Lloyd-Davis Rectal Scissor	263
Lloyd-Davis Sigmoidoscope	264
Lockhart Mummery Fistula Director	258
Logan Turner Probe	155
Logans Traction Bow	108
London Splint Mallet	208
Loops	141
Lord Rectal Dilator	258
Love Nerve Root Retractor	245
Love-Grunwald Rongeur	250
Lowman Bone Holding Clamp	199
Luc Turbinate Forcep	168
Lucae Aural Dressing Forcep	112
Lucae Cerumen Hook	135
Lucae Nasal Forcep	147
Luer Rongeur	215
Luer Vulsellum Forcep	235
Lung Forceps	173

### M

MacDonald Dissector	18
MacEwen Chisel	79
MacEwen Osteotome	209
MacGregor Nasal Osteotome	89
Mackie Curette	138
Macphail Needleholder	23
Magauran Plate	132
Magill Insulated Suction Tube	163
Magill Introducing Forcep	19



## Index - Alphabetical

Magill Suction Tube	164
Magill Universal Suction Tube	164
Maingot Bile Duct Dilator	13
Maingot Clamp	224
Maingot Dissecting Forcep	16
Malar Elevator	82
Mallet For Ultra Fine Osteotome	84
Mallets	84
Mallets	207
Maltz Nasal Rasp	91
Mammary Retractor	97
Mandibular Awl	78
Mapping Pens	85
Marin Reamer And Bur	202
Martin Splinter Forcep	69
Maryfield Catheter Introducer	273
Mathieu Needleholder	23
Mathieu Retractor	245
Matthew Osteotome	89
Maxilla Stripping Retractor	102
Mayo Adson Self Retaining Retractor	246
Mayo Artery Forcep	3
Mayo External Vein Stripper	76
Mayo Instrument Pin	19
Mayo Lung Forcep	173
Mayo Needleholder	23
Mayo Needleholder - Tungsten Carbide	26
Mayo Oschner Artery Forcep	3
Mayo Scissor	61
Mayo Scissor - Tungsten Carbide	65
Mayo Scissor - Ultra Cutting	68
Mayo-Stille Scissor - Tungsten Carbide	66
Mayo-Stille Scissor - Ultra Cutting	68
McClintock Ovum Forcep	229
McEwen Curette	81
McGee Aural Forcep	116
McGoey Punch	211
McIndoe Bone Cutting Forcep	198
McIndoe Chisel	79
McIndoe Dissecting Forcep	17
McIndoe Double Skin Hook	108
McIndoe Nasal Rasp	91
McIndoe Retractor	99
McIndoe Single Skin Hook	108
McKenzie Clip Forcep	239
McKeown Self Retaining Retractor	47
McKissocks Dural Scissor	253
Measures	20
Metzenbaum Scissor	60
Metzenbaum Scissor	61
Metzenbaum Scissor - Tungsten Carbide	66
Metzenbaum Scissor - Ultra Cutting	68
Michel Clip Forcep	11
Miller Acetabular Bone Curette	197
Millin Bladder Neck Spreader	275
Millin Boomerang Needleholder	275
Millin Retropubic Self Retaining Retractor	276
Millin Suction Tube	71
Millins Dissecting Forcep	274
Mirrors	141
Mitchell Rugine	216
Mitchell Trimmer	82

Mixer Artery Forcep	4
Mixer Baby Artery Forcep	4
Mollison Dissector	138
Mollison Self Retaining Retractor	158
Monaghan Scissor	232
Moore Femoral Head Extractor	205
Moorfield Suture Holding Forcep	280
Morris Retractor	35
Morris Toothed Retractor	35
Morrison Davies Rib Raspatory	179
Morse Twist Drill	220
Morse-Favaloro Rib Spreader	185
Moseley Fasciatome	219
Mount Vernon Dissecting Forcep	81
Mouth Gags	20
Mouth Gags	143
Mouth Jacks	145
Mouth Props	85
Mowlem Nasal Saw	86
Moynihan Artery Forcep	4
Moynihan Cholecystectomy Forcep	7
Moynihan Gallstone Probe And Scoop	29
Moynihan Retractor	36
Murphy Skid	201
Musgrove Wool Carrier	169
Mustarde Fascia Splitter	220
Mustarde Offset Orbital Retractor	99
Myer Vein Stripper	76
Myles Naso Antrum Perforator	154
Myoma Screws	228
Myringotomes	146

## N

Nabatoff Vein Stripper	77
Nail Instruments	208
Nasal Forceps	146
Nasal Instruments	147
Nasal Knives	149
Nasal Rasps	149
Nasal Saws	86
Nasal Snares	150
Nasal Specula	150
National Hospital Percussor	28
Naunton Morgan Needleholder	24
Naunton Morgan Rectal Speculum	261
Necrosis (Sequestrum) Bone Holding Forcep	199
Needleholders	21
Needleholders	86
Needleholders	275
Needleholders - Tungsten Carbide	24
Needleholders - Tungsten Carbide	87
Needleholders - Tungsten Carbide	244
Needles	27
Needles	275
Negus Artery Forcep	111
Negus Aspirating Dissector	138
Negus Knot Tier And Pusher	140
Negus Mouth Jack	145
Negus Nasal Snare	150
Neivert Needleholder - Tungsten Carbide	26
Neivert Osteotome	89

## Index - Alphabetical

Nelson Dissecting Forcep	172
Nelson Emphyema Trocar	195
Nelson Lobectomy Scissor	62
Nelson Lobectomy Scissor - Tungsten Carbide	66
Nelson Rib Raspatory	179
Nelson Trocar	75
Nerve Dural Hook	241
Nettleship Lachrymal Dilator	281
Nibbling Forceps	153
Nickel Silver Probe With Eye	30
Nodule Forceps	153
Norfolk And Norwich Self Retaining Retractor	48
Northfield Rongeur	251
Novak Suction Curette	225

### O

Obstetric Forceps	229
O'Connell Nerve Root Retractor	245
Officer Biopsy Forcep	257
Officer Dissecting Forcep	258
Ogilvie Retractor	36
Oldfield Retractor	36
Olivecrona Rongeur	251
Ollier Retractor	36
Olsen-Hegar Needleholder - Tungsten Carbide	244
Oral Forceps	87
Oringer Cheek And Lip Retractor	99
Ormerod Aural Forcep	116
Ormerod Scissor	159
Oschner Artery Forcep	5
O'Shaughnessy Artery Forcep	5
Osteotomes	88
Osteotomes	209
Ovum Forceps	229

### P

Paget Knife	20
Palate Levers	154
Papworth Rib Spreader	190
Park Anal Self Retaining Retractor	262
Park Combined Self Retaining Retractor	263
Parker Kerr Clamp	9
Parker-Langenbeck Retractor	36
Parkes Hump Gouge	83
Paterson Biopsy Forcep	131
Paton Bone Cutting Forcep	198
Paton Bur	202
Paton Cartilage Retractor	36
Payr Clamp	9
Pelvic Support	285
Pennybacker Dissecting Forcep	240
Pennybacker Dissector	241
Pennybacker Elevator	242
Pennybacker Rongeur	251
Percussors	28
Perforators	154
Perfusion	174
Perineal Instrument Tray	283
Peritoneum Forceps	230
Pessary Introducer	228

Peters (Siegle) Aural Speculum	130
Pituitary Forceps	154
Plain Bone Awl	196
Plain Clamp	282
Plain Instrument Tray	284
Plaster Instruments	28
Plate Benders	210
Playfair Probe	230
Politzer Myringotome	146
Poole Suction Tube	71
Popper Dissector	138
Portmann Scissor	159
Post Mortem Scissor	63
Poswillo Malar Hook	84
Potts-Smith Scissor	190
Potts-Smith Scissor - Tungsten Carbide	191
Prendiville Hand Table	109
Price Thomas Rib Raspatory	179
Price Thomas Rib Spreader	186
Probes	29
Probes	154
Probes	178
Probes	230
Proctoscopes	259
Prognathism Channel Retractor	100
Proust Retractor	37
Provis Intra Uterine Cannula	222
Punch Forceps	155
Punch Forceps	230
Punches	178
Punches	211
Putti Rasp	212
Pyrah Retractor	37

### R

Ramley Sponge Holding Forcep	70
Ramsey Dissecting Forcep	17
Randall Curette	225
Randall Renal Calculus Stone Forcep	277
Raney Clip Forcep	239
Raspatories	90
Raspatories	179
Raspatories	211
Rasps	91
Rasps	212
Rayne Mandibular Retractor	101
Read Chisel	80
Read Gouge	84
Read Osteotome	89
Read Periosteal Elevator	82
Reamers	92
Rectal Specula	261
Reidy Nasal Rasp	91
Retractors	30
Retractors	92
Retractors	157
Retractors	180
Retractors	212
Retractors	231
Retractors	244
Retractors	275
Retractors	281



## Index - Alphabetical

Retractors - Self Retaining	41
Retractors - Self Retaining	158
Retractors - Self Retaining	214
Retractors - Self Retaining	245
Retractors - Self Retaining	262
Retractors - Self Retaining	276
<b>Rheinstadter Uterine Flushing Curette</b>	225
Rib Shears	182
Rib Spreaders	183
<b>Ricard Begouin Griffiths Self Retaining Retractor</b>	48
<b>Ricard Begouin Self Retaining Retractor</b>	48
<b>Richards Suction Tube</b>	265
<b>Roberts Artery Forcep</b>	170
<b>Roberts Periosteal Elevator</b>	82
<b>Rochard Sternal Lifting Retractor</b>	193
<b>Rochester-Pean Artery Forcep</b>	5
<b>Ronald Edwards Artery Forcep</b>	6
<b>Ronald Edwards Rib Raspatory</b>	179
<b>Ronald Edwards Rib Spreader</b>	186
Rongeurs	215
Rongeurs	247
<b>Rosen Aural Instruments</b>	123
<b>Rosen Aural Speculum</b>	129
<b>Ross Aortic Retractor</b>	181
<b>Ross Atrial Basket</b>	177
<b>Ross Coronary Artery Probe</b>	178
<b>Ross Sump Sucker</b>	177
<b>Ross Ventricular Vent</b>	177
<b>Rotary Clamp - Toothed</b>	282
<b>Rotunda Catheter</b>	223
<b>Rowbotham Suction Tube</b>	164
<b>Rowe Boat Hook Retractor</b>	213
<b>Rowe Buccal Retractor</b>	101
<b>Rowe Disimpaction Oral Forcep</b>	88
<b>Rowe Lingual Retractor</b>	101
<b>Rowe Maxillary Labial Flap Retractor</b>	101
<b>Rowe Zygomatic Elevator</b>	82
<b>Royal National ENT Hospital Biopsy Forcep</b>	132
<b>Rozner Osteotome</b>	89
<b>Rubber Mouth Prop</b>	85
Rugines	158
Rugines	216
<b>Ruskin Rongeur</b>	252
<b>Ryder Needleholder - Tungsten Carbide</b>	27

### S

<b>Sargent Intestinal Depressor</b>	12
<b>Sarns Suction Tube</b>	193
<b>Savage Intestinal Decompressor</b>	12
Saws	56
Saws	252
<b>Sawtell Artery Forcep</b>	111
<b>Scalpel Handle</b>	56
Scalpel Handles	56
Scalpel Handles	103
<b>Schnidt Artery Forcep</b>	111
<b>Schoemaker-Ogilvie Clamp</b>	10
<b>Schroeder Uterine Vulsellum Forcep</b>	235
<b>Schuknecht Aural Instruments</b>	125
<b>Schuknecht Suction Tube</b>	164
Scissors	57

Scissors	104
Scissors	159
Scissors	190
Scissors	232
Scissors	253
Scissors	263
Scissors - Tungsten Carbide	65
Scissors - Tungsten Carbide	191
Scissors - Ultra Cutting	67
Scoops	161
<b>Scott Stevenson Tonsil Scissor</b>	160
<b>Scoville Centering Drill</b>	255
<b>Scoville Trephine</b>	256
Screw Holding Forceps	216
Screw Jacks	217
Screwdrivers	217
Seekers	161
<b>Self-Clearing Suction Tube</b>	164
<b>Sellors Rib Spreader</b>	187
<b>Sellors Rib Spreader and Approximator</b>	186
<b>Semb Erector Spinae Retractor</b>	181
<b>Semb Raspatory</b>	179
Septum Forceps	104
<b>Serrated One End Mallet</b>	208
<b>Seward Retractor</b>	101
<b>Seymour Jones Antrum Punch Forcep</b>	156
<b>Shah Nasal Speculum</b>	151
<b>Shardle Towel Clip</b>	75
<b>Sharman Endometrial Curette</b>	226
<b>Shea Aural Forcep</b>	117
<b>Shea Aural Instruments</b>	126
<b>Shea Aural Speculum</b>	130
<b>Shea Aural Speculum Holder</b>	128
Shears	253
<b>Shouldered Bone Awl</b>	196
<b>Shucksmith Retractor</b>	37
Sigmoidoscopes	264
<b>Silver Probe With Eye</b>	30
<b>Silver Skin Graft Knife</b>	106
<b>Simple Pattern Haemorrhoid Ligator</b>	259
<b>Simpson Obstetric Forcep</b>	229
<b>Simpson Smith Suction Tube</b>	71
<b>Simpson Uterine Sound</b>	233
<b>Sims Uterine Curette</b>	226
<b>Sims Vaginal Speculum</b>	234
Sinus Forceps	69
<b>Sinus Probe</b>	30
Skin Graft Boards	105
Skin Graft Knives	106
Skin Graft Plates	161
Skin Hooks	106
<b>Slightly Curved Tongue Depressor</b>	165
<b>Smilie Menisectomy Knife</b>	206
<b>Smillie Knee Joint Retractor</b>	213
<b>Smillie Punch</b>	211
<b>Smith-Petersen Gouge</b>	205
<b>Smith-Petersen Osteotome</b>	210
<b>Smithwick Sympathectomy Hook</b>	241
<b>Sommerlad Pen</b>	85
Sounds	192
Sounds	233
<b>Southampton Western Hospital Suction Tube</b>	194

## Index - Alphabetical

<b>Spackman Intra Uterine Cannula</b>	222
Specula	277
<b>Spencer Scissor</b>	63
<b>Spencer-Wells Artery Forcep</b>	6
<b>Spiral Undercut Bur</b>	238
Splinter Forceps	69
Sponge Holding Forceps	70
<b>Spring Rib Shear</b>	182
<b>St.Bartholomews Cerumen Hook</b>	135
<b>St.Bartholomews Ethmoid Punch Forcep</b>	156
<b>St.Barts Intestinal Depressor</b>	12
<b>St.Clair Thomson Curette</b>	138
<b>St.Clair Thomson Dissector</b>	138
<b>St.Clair Thomson Nasal Speculum</b>	152
<b>St.Marks (Perineal) Self Retaining Retractor</b>	277
<b>St.Marks Biopsy Forcep</b>	257
<b>St.Marks Dissecting Forcep</b>	17
<b>St.Marks Hospital Patten Instrument Tray</b>	284
<b>St.Marks Hospital Retractor</b>	38
<b>St.Marks Proctoscope</b>	260
<b>St.Marks Rectal Dilator</b>	258
<b>St.Martin Suturing Forcep</b>	280
<b>St.Thomas Bone Holding Forcep</b>	200
<b>St.Thomas Hospital Raspatory</b>	211
<b>St.Thomas Hospital Self Retaining Retractor</b>	50
<b>Stack Retractor</b>	38
<b>Stacke Probe</b>	30
<b>Stainless Steel Rule</b>	20
<b>Stamm Bone Cutting Forcep</b>	199
<b>Stanford Cade Insufflator</b>	140
Staple Instruments	217
<b>Steinmann Pin Cap</b>	218
Steriliser Forceps	70
Sternal Lifting Retractors	192
<b>Stevens Abdominal Self Retaining Retractor</b>	50
<b>Stevens Scissor</b>	63
<b>Stevens Scissor - Ultra Cutting</b>	68
<b>Stille-Lorenz Plaster Shears</b>	29
Stirrups	218
Stone Forceps	277
<b>Strabismus Scissor</b>	280
<b>Strabismus Scissor - Ultra Cutting</b>	69
<b>Straight Heart / Lung Connector</b>	178
<b>Suction Model Haemorrhoid Ligator</b>	259
Suction Tubes	70
Suction Tubes	108
Suction Tubes	161
Suction Tubes	193
Suction Tubes	234
Suction Tubes	254
Suction Tubes	265
Suction Tubes	278
Supports	285
Suture Forceps	72
Suture Forceps	219
Suture Pushers	108
<b>Swedish Chisel</b>	203
<b>Swedish Dissector</b>	241
<b>Swedish Gouge</b>	206
<b>Swedish Laminectomy Shear</b>	253
<b>Swedish Osteotome</b>	210
<b>Swift Joly Self Retaining Retractor</b>	48

<b>Syme Dissector</b>	139
<b>Syme Periosteal Elevator</b>	83
<b>Symes Needle</b>	28
Syringes	108
Syringes	165

## T

<b>Teales Gorget</b>	274
<b>Teales Uterine Vulsellum Forcep</b>	235
Tendon Hooks	219
Tendon Instruments	219
<b>Tessier Maxillary Mobiliser</b>	102
<b>Thexton Tongue And Flap Retractor</b>	103
<b>Thomson-Walker Needleholder</b>	24
<b>Thomson-Walker Pedicle Clamp</b>	273
<b>Thomson-Walker Penile Clamp</b>	273
<b>Thudichum Nasal Speculum</b>	152
<b>Tibbs Arterial Cannula</b>	173
<b>Tilley Antrum Bur</b>	134
<b>Tilley Aural Dressing Forcep</b>	112
<b>Tilley Gouge</b>	140
<b>Tilley Harpoon Trocar</b>	167
<b>Tilley Henckel Ethmoid Punch Forcep</b>	157
<b>Tilley Lichwitz Trocar</b>	168
<b>Tilley Nasal Forcep</b>	147
<b>Tinckler (Simpson Smith) Suction Tube</b>	71
Tissue Forceps	72
Tissue Forceps - Atraumatic	194
<b>Tobbold Tongue Depressor</b>	166
<b>Todd Mallet</b>	208
<b>Toffee Hammer</b>	85
Tongue Depressors	165
Tongue Forceps	74
Tongue Forceps	166
Tonsil Holding Forceps	167
Tonsil Snares	167
Towel Clips	74
<b>Toynbee Aural Speculum</b>	130
Tracheal Dilators	167
<b>Tracheal Hook Retractor</b>	39
Traction Apparatus	254
Traction Bows	108
Traction Tongs	255
<b>Trautmann Myringotome</b>	146
<b>Travers Self Retaining Retractor</b>	51
Trephines	255
<b>Trethowan Bone Lever</b>	202
<b>Treves Dissecting Forcep</b>	17
Trocars	75
Trocars	167
Trocars	195
<b>Trotter Rongeur</b>	252
<b>Trousseau Tracheal Dilator</b>	167
<b>Tubby File</b>	205
<b>Tubing Clamp</b>	10
<b>Tudor Edwards Double Rib Spreader</b>	189
<b>Tudor Edwards Mod Tuffier Rib Spreader</b>	188
<b>Tudor Edwards Periosteal Elevator</b>	173
<b>Tudor Edwards Rib Shear</b>	182
<b>Tudor Edwards Rib Spreader</b>	188
<b>Tudor Edwards Scapula Retractor</b>	182

## Index - Alphabetical

Tudor Edwards Support	285
Tuffier Rib Spreader	189
Tufnol Handled Bone Curette	197
Tufnol Mallet	208
Tufnol Skin Graft Board	106
Tulloch Brown Bone Holding Forcep	200
Tumarkin Aural Speculum	131
Tumarkin Wool Carrier	169
Turbinate Forceps	168
Turner Warwick Bladder Neck Spreader	276
Turner Warwick Dilator	274
Turner Warwick Mod. Hey Groves Bougie	270
Turner Warwick Posterior Urethral Suture Needle	275
Turner Warwick Speculum	277
Turner Warwick Suction Tube	278
Turner Warwick Universal Self Retaining Retractor	51
Turner Warwick Urological Retractor	276
Turn-Over-End Dissecting Forcep	17
Twist Drills	220

### U

Ultra Fine Osteotome	90
Umbilical Dilator	227
Umbilical Scissor	232
Universal Bandage Scissor	64
Universal Fibrelight Adaptor	110
Universal Suction Tube	72
Universal Wire Cutting Scissor - Tungsten carbide	67
Uterine Forceps	234
Uterine Scissor	233

### V

Vaginal Specula	234
Vant Episiotomy Scissor	233
Various	109
Vehmehren Costotome	172
Vein Strippers	76
Verhoeven Suction Tube	165
Volkman Bone Curette	197
Volkman Retractor	39
Vulsellum Forceps	235

### W

Walsham Septum Forcep	105
Walton Retractor	40
Ward Cheek Retractor	103
Ward Chisel	80
Ward Needleholder	24
Ward Osteotome	90
Ward Periosteal Elevator	83
Warwick James Elevator	83
Waterston Rib Spreader	190
Watson Cheyne Dissector	18
Watson Jones Introducer	221
Watson Orbital Retractor	281
Watson Skin Graft Knife	106
Watson-Williams Cannula	135

Watson-Williams Nasal Rasp	149
Waugh Dissecting Forcep	17
Weir Nasal Sucker / Dissector	139
Weislander Self Retaining Retractor	55
Welch Allyn Fibrelight Adaptor	110
Wertheim Vaginal Retractor	231
West Self Retaining Retractor	56
Whitlock Lingual Retractor	103
Wilde Aural Dressing Forcep	112
Williams Self Retaining Screwdriver	217
Wilson Artery Forcep	111
Wilson Frame	289
Wilson Pituitary Forcep	154
Wilson Tonsil Scissor	160
Winsbury White Urethral Bougie	271
Wire Brush	7
Wire Cutting Scissor	64
Wire Forceps	109
Wire Instruments	220
Wittner Cervical Biopsy Punch	231
Woakes Eustachian Catheter	135
Woods Tonsil Scissor	160
Wool Carriers	169
Wrigley Obstetric Forcep	229
Wroblenski Dislocating Hook	204
Wyndham Powell Bougie	272

### Y

Y Heart / Lung Connector	178
Yankauer Suction Tube	72
Yeoman Biopsy Forcep	257
Young Tongue Forcep	166

### Z

Zachary Cope Anastomosis Clamp	10
Zoellner Detachable End	165
Zoellner Skin Graft Plate	161
Zoellner Suction Tube	165
Zygomatic Suspension Awl	78



## Index - Numerical

11000-18	1	11310-24	5	12120-23	9	13440-18	14	13710-20	17
11010-18	1	11320-14	5	12120-25	9	13440-20	14	13720-15	17
11020-18	1	11320-16	5	12130-23	9	13440-25	14	13720-18	17
11030-18	1	11320-18	5	12130-25	9	13441-15	14	13720-20	17
11040-35	1	11320-20	5	12140-20	9	13441-18	14	13900-19	18
11040-50	1	11320-22	5	12140-25	9	13441-20	14	13910-16	18
11050-35	1	11320-24	5	12150-17	10	13442-12	14	13920-16	18
11050-50	1	11330-14	5	12150-21	10	13442-15	14	13930-18	18
11060-12	1	11330-16	5	12160-14	10	13442-18	14	13940-19	18
11060-18	1	11330-18	5	12160-18	10	13442-20	14	13940-25	18
11070-12	1	11330-20	5	12170-10	10	13442-25	14	13950-12	18
11080-18	1	11330-22	5	12170-20	10	13442-30	14	13950-18	18
11090-14	1	11330-24	5	12170-30	10	13445-23	14	14000-12	18
11090-18	1	11330-26	5	12170-90	10	13446-23	15	14020-12	18
11100-14	2	11340-14	5	12200-18	10	13450-18	15	14300-14	19
11100-18	2	11340-16	5	12200-23	11	13460-18	15	14400-10	19
11110-12	2	11340-18	5	12210-18	11	13465-14	15	14400-15	19
11120-09	2	11340-20	5	12210-23	11	13470-14	15	14500-19	19
11120-12	2	11340-22	5	12300-14	11	13470-15	15	14600-19	19
11130-12	2	11340-24	5	12320-12	11	13480-14	15	14600-23	19
11140-09	2	11340-26	5	12340-12	11	13480-15	15	14750-20	20
11140-12	2	11345-10	6	12360-12	12	13490-10	15	14750-22	20
11150-20	2	11345-20	6	12400-50	12	13490-12	15	14750-25	20
11160-20	2	11345-30	6	12500-25	12	13490-15	15	14750-30	20
11170-20	2	11350-12	6	12520-45	12	13490-16	15	14760-20	20
11180-14	2	11350-15	6	13060-20	12	13490-17	15	14760-21	20
11180-16	2	11350-18	6	13200-03	13	13490-20	15	14770-10	20
11190-14	2	11350-20	6	13200-04	13	13490-25	15	14770-12	20
11190-16	2	11350-23	6	13200-05	13	13490-30	15	14770-15	20
11200-14	3	11360-12	7	13200-06	13	13510-20	15	14770-18	20
11210-14	3	11360-15	7	13200-07	13	13520-15	16	14780-14	20
11220-12	3	11360-18	7	13200-08	13	13521-15	16	15000-15	20
11220-14	3	11360-20	7	13200-09	13	13530-14	16	15000-30	20
11220-15	3	11360-23	7	13200-10	13	13530-18	16	15110-17	20
11220-18	3	11800-28	7	13200-11	13	13540-18	16	15110-20	20
11220-20	3	11900-23	7	13200-90	13	13550-14	16	15120-17	20
11220-23	3	11910-23	7	13205-03	13	13560-12	16	15120-20	20
11230-12	3	11920-19	7	13205-05	13	13560-14	16	15200-20	21
11230-14	3	11920-23	7	13205-07	13	13560-18	16	15210-15	21
11230-15	3	11930-21	7	13220-04	13	13560-20	16	15210-18	21
11230-18	3	12010-10	8	13220-06	13	13570-12	16	15210-20	21
11230-20	3	12010-20	8	13220-08	13	13570-14	16	15210-23	21
11230-23	3	12010-30	8	13220-90	13	13570-18	16	15210-25	21
11240-18	3	12010-40	8	13300-14	13	13570-20	16	15210-30	21
11250-18	3	12010-90	8	13300-16	13	13580-14	16	15220-14	21
11260-15	3	12020-17	8	13300-20	13	13590-14	16	15230-12	21
11270-14	4	12020-23	8	13310-14	13	13600-28	16	15240-12	22
11270-18	4	12030-17	8	13310-16	13	13610-15	17	15250-20	22
11275-15	4	12030-23	8	13310-20	13	13620-15	17	15260-13	22
11275-18	4	12040-23	8	13320-14	13	13640-18	17	15260-16	22
11275-22	4	12040-25	8	13320-16	13	13650-18	17	15270-15	22
11280-14	4	12050-23	8	13320-20	13	13660-18	17	15280-15	23
11280-18	4	12050-25	8	13340-15	13	13670-29	17	15280-18	23
11290-14	4	12060-10	8	13400-12	14	13680-29	17	15280-20	23
11290-18	4	12060-12	8	13410-12	14	13690-12	17	15290-17	23
11300-15	5	12060-15	8	13410-18	14	13690-15	17	15290-20	23
11300-18	5	12070-10	8	13415-18	14	13690-18	17	15300-15	23
11300-20	5	12070-12	8	13420-12	14	13690-20	17	15310-12	23
11310-14	5	12070-15	8	13430-12	14	13690-25	17	15310-14	23
11310-16	5	12080-21	9	13430-18	14	13700-12	17	15310-16	23
11310-18	5	12090-30	9	13435-18	14	13700-15	17	15310-18	23
11310-20	5	12100-30	9	13440-12	14	13710-15	17	15310-20	23
11310-22	5	12110-20	9	13440-15	14	13710-18	17	15310-23	23

## Index - Numerical

15310-25	23	16030-35	29	16230-25	34	16370-18	39	16530-90	43
15310-30	23	16040-12	30	16240-06	35	16380-18	39	16540-90	43
15320-18	24	16040-15	30	16240-08	35	16390-18	39	16545-85	43
15320-25	24	16040-18	30	16240-11	35	16400-10	39	16550-05	44
15330-20	24	16040-20	30	16240-13	35	16400-20	39	16550-10	44
15340-18	24	16040-23	30	16240-15	35	16400-30	39	16550-15	44
15400-15	24	16040-25	30	16240-20	35	16400-40	39	16550-20	44
15400-18	24	16040-30	30	16240-25	35	16400-50	39	16550-25	44
15400-20	24	16045-12	30	16250-30	35	16400-60	39	16550-30	45
15400-23	24	16045-15	30	16250-40	35	16410-10	39	16550-35	45
15400-25	24	16045-18	30	16250-45	35	16410-20	39	16550-40	45
15400-30	24	16045-20	30	16255-30	35	16410-30	39	16550-45	45
15410-18	25	16045-23	30	16255-45	35	16410-40	39	16550-50	43
15410-20	25	16045-25	30	16255-60	35	16410-50	39	16550-90	43
15410-23	25	16045-30	30	16260-40	35	16410-60	39	16560-10	46
15410-25	25	16050-15	30	16260-50	35	16420-10	39	16560-20	46
15410-30	25	16060-10	30	16260-65	35	16420-20	39	16560-50	46
15420-12	25	16100-24	30	16270-40	35	16420-30	39	16560-55	46
15430-20	25	16105-70	31	16270-50	35	16420-40	39	16560-60	46
15430-26	25	16105-90	31	16270-65	35	16420-50	39	16560-65	46
15440-12	25	16110-10	31	16271-30	35	16420-60	39	16560-70	46
15460-13	26	16110-20	31	16280-13	36	16430-06	40	16560-80	46
15460-16	26	16120-15	31	16283-20	36	16430-08	40	16560-90	46
15470-15	26	16120-20	31	16285-40	36	16430-11	40	16570-90	46
15490-12	26	16120-25	31	16285-50	36	16430-12	40	16580-90	46
15490-14	26	16120-30	31	16295-13	36	16430-13	40	16590-90	46
15490-16	26	16130-18	31	16295-25	36	16430-16	40	16600-90	46
15490-18	26	16140-02	31	16295-37	36	16430-19	40	16605-18	47
15490-20	26	16140-05	31	16320-21	36	16430-25	40	16610-15	47
15490-23	26	16140-10	31	16330-31	36	16430-32	40	16620-90	47
15490-25	26	16140-20	31	16330-44	36	16430-38	40	16625-90	47
15490-30	26	16140-30	31	16330-51	36	16430-50	40	16630-21	48
15495-12	26	16140-40	31	16332-65	37	16430-63	40	16640-20	48
15500-12	27	16140-50	31	16334-10	37	16435-08	40	16645-28	48
15500-15	27	16140-90	31	16334-20	37	16435-13	40	16650-05	48
15500-18	27	16150-02	32	16334-30	37	16435-16	40	16650-10	48
15500-20	27	16150-05	32	16334-40	37	16435-19	40	16650-15	49
15500-23	27	16150-10	32	16334-50	37	16435-25	40	16650-20	49
15500-25	27	16150-20	32	16336-03	37	16440-13	40	16650-50	49
15600-14	27	16150-30	32	16336-05	37	16440-19	40	16650-90	49
15610-21	27	16150-40	32	16336-06	37	16440-25	40	16655-90	50
15620-20	27	16150-50	32	16336-08	37	16440-32	40	16658-05	50
15630-10	27	16150-90	32	16336-09	37	16440-38	40	16658-10	50
15630-20	27	16160-09	32	16336-11	37	16440-50	40	16658-15	50
15630-30	27	16160-10	32	16336-12	37	16440-63	40	16658-20	50
15640-19	27	16160-11	32	16336-14	37	16450-13	40	16658-25	50
15650-27	27	16170-09	32	16336-15	37	16450-19	40	16658-30	50
15660-27	27	16170-10	32	16336-17	37	16450-25	40	16658-35	50
15670-17	28	16170-11	32	16336-90	37	16450-32	40	16658-40	51
15680-17	28	16180-10	32	16340-12	38	16450-38	40	16658-45	51
15690-10	28	16180-16	32	16340-17	38	16450-45	40	16658-50	50
15690-20	28	16180-22	32	16340-20	38	16450-50	40	16658-52	50
15690-30	28	16190-24	33	16342-12	38	16450-63	40	16658-54	50
15700-16	28	16195-34	33	16342-17	38	16460-50	41	16658-56	50
15800-33	28	16205-23	33	16342-20	38	16500-09	41	16658-60	51
15900-25	28	16206-23	33	16345-20	38	16500-10	41	16658-70	51
15910-24	28	16210-38	34	16350-12	38	16500-18	41	16658-90	51
15920-25	29	16210-57	34	16350-17	38	16505-19	41	16660-20	51
15930-29	29	16211-38	34	16352-12	38	16510-60	42	16670-05	51
15940-28	29	16211-57	34	16352-17	38	16520-10	42	16670-10	52
15960-23	29	16220-11	34	16358-13	38	16520-20	42	16670-15	52
15960-26	29	16220-14	34	16358-25	38	16520-30	42	16670-20	52
15960-37	29	16230-13	34	16360-18	39	16520-90	42	16670-25	53

## Index - Numerical

16670-30	53	17210-20	58	17430-23	62	17810-14	66	19150-09	75
16670-35	53	17220-12	58	17440-23	62	17810-17	66	19170-16	75
16670-40	53	17220-14	58	17450-14	63	17810-20	66	19170-21	75
16670-45	54	17230-10	59	17460-10	63	17810-23	66	19200-08	75
16670-50	54	17230-12	59	17490-10	63	17815-23	66	19200-09	75
16670-52	54	17230-14	59	17493-11	63	17816-23	66	19200-10	75
16670-54	54	17230-15	59	17494-11	63	17820-12	67	19210-22	75
16670-56	55	17230-18	59	17495-11	64	18000-12	69	19210-27	75
16670-58	55	17230-20	59	17496-11	64	18000-15	69	19210-33	75
16670-60	55	17235-08	59	17500-17	64	18000-18	69	19280-06	76
16670-65	55	17240-14	59	17510-12	64	18000-20	69	19280-10	76
16670-70	55	17240-15	59	17600-14	67	18200-12	69	19280-13	76
16670-75	55	17240-18	59	17610-14	67	18210-10	69	19280-50	76
16670-80	55	17245-10	59	17620-11	67	18220-07	69	19280-60	76
16670-90	55	17260-15	59	17630-11	67	18220-09	69	19280-90	76
16670-95	55	17270-14	60	17635-11	67	18220-11	69	19289-05	76
16680-14	55	17270-18	60	17636-11	67	18300-18	70	19289-07	76
16690-14	55	17270-20	60	17640-14	68	18300-24	70	19289-09	76
16700-14	56	17270-23	60	17640-17	68	18310-18	70	19290-05	76
16900-20	56	17280-18	60	17640-20	68	18310-24	70	19290-07	76
16900-22	56	17280-21	60	17640-21	68	18320-18	70	19290-09	76
16920-10	56	17290-16	60	17650-14	68	18320-24	70	19300-06	76
17020-30	56	17290-19	60	17650-17	68	18410-26	70	19300-10	76
17020-35	56	17300-12	60	17650-20	68	18600-10	70	19300-13	76
17020-40	56	17310-12	60	17650-21	68	18601-10	70	19300-50	76
17020-45	56	17310-14	60	17655-15	68	18610-17	71	19310-06	77
17020-70	57	17310-18	60	17655-17	68	18620-10	71	19310-09	77
17100-15	57	17330-14	61	17655-19	68	18650-24	71	19310-12	77
17110-14	57	17330-16	61	17656-15	68	18660-24	71	19310-15	77
17120-15	57	17330-19	61	17656-17	68	18664-15	71	19310-20	77
17130-14	57	17330-21	61	17656-19	68	18665-31	71	19310-50	77
17140-16	57	17340-14	61	17660-14	68	18665-50	71	19310-55	77
17140-20	57	17340-17	61	17660-18	68	18670-25	71	19310-60	77
17160-18	57	17350-14	61	17660-20	68	18680-10	72	19310-65	77
17170-10	57	17350-16	61	17660-23	68	18680-20	72	19310-90	77
17170-12	57	17350-19	61	17660-26	68	18680-30	72	19320-06	77
17170-14	57	17350-21	61	17670-14	68	18680-40	72	19320-09	77
17170-15	57	17360-14	61	17680-11	68	18680-50	72	19320-12	77
17170-18	57	17360-17	61	17681-11	68	18680-60	72	19320-15	77
17170-20	57	17370-14	61	17690-11	69	18680-90	72	19320-20	77
17180-10	58	17370-18	61	17691-11	69	18700-30	72	19320-50	77
17180-12	58	17370-20	61	17700-14	65	18700-50	72	19320-55	77
17180-14	58	17370-23	61	17710-14	65	18800-15	72	19320-60	77
17180-15	58	17370-25	61	17720-14	65	18900-30	72	21000-22	78
17180-18	58	17370-28	61	17730-14	65	18910-20	73	21010-10	78
17180-20	58	17370-30	61	17740-14	65	18910-30	73	21015-10	78
17190-10	58	17380-14	60	17750-14	65	18910-40	73	21020-14	78
17190-12	58	17380-18	60	17755-11	65	18910-50	73	21025-14	78
17190-14	58	17380-20	60	17756-11	65	18910-60	73	21030-14	78
17190-15	58	17380-23	60	17760-14	65	18920-16	73	21040-18	78
17190-18	58	17390-14	61	17760-17	65	18920-20	73	21200-05	78
17190-20	58	17400-14	62	17760-19	65	18920-23	73	21210-05	78
17200-10	58	17400-18	62	17770-14	65	18930-13	73	21220-05	78
17200-12	58	17400-20	62	17770-17	65	18940-19	73	21230-10	78
17200-14	58	17400-23	62	17770-19	65	18950-12	74	21230-20	78
17200-15	58	17410-14	62	17780-15	66	18950-15	74	21230-30	78
17200-18	58	17420-14	62	17780-17	66	18950-19	74	21230-40	78
17200-20	58	17420-18	62	17790-15	66	18960-18	74	21230-50	78
17210-10	58	17420-20	62	17790-17	66	19000-13	74	21230-60	78
17210-12	58	17420-23	62	17800-14	66	19000-17	74	21235-03	79
17210-14	58	17420-25	62	17800-17	66	19100-09	74	21235-05	79
17210-15	58	17420-28	62	17800-20	66	19100-12	75	21238-04	79
17210-18	58	17420-30	62	17800-23	66	19130-09	75	21238-05	79



## Index - Numerical

21238-06	79	22000-17	83	23210-05	88	23505-50	92	23639-40	97
21238-07	79	22170-03	83	23210-07	88	23510-19	92	23639-50	97
21240-18	79	22170-04	83	23210-10	88	23515-25	93	23640-10	98
21250-18	79	22170-05	83	23210-12	88	23520-10	93	23642-25	98
21260-18	79	22195-10	83	23210-15	88	23530-08	93	23642-40	98
21270-02	79	22200-02	84	23215-11	89	23530-12	93	23642-44	98
21270-04	79	22200-03	84	23215-13	89	23530-14	93	23643-25	98
21270-06	79	22200-04	84	23215-15	89	23530-16	93	23643-40	98
21270-08	79	22200-05	84	23220-11	89	23530-18	93	23643-44	98
21270-10	79	22200-06	84	23226-10	89	23532-30	93	23644-25	97
21270-12	79	22300-19	84	23226-20	89	23534-17	93	23648-13	99
21270-14	79	22380-15	84	23226-30	89	23536-10	94	23650-44	99
21280-10	79	22400-21	84	23230-02	89	23536-20	94	23650-51	99
21280-13	79	22500-06	84	23230-03	89	23536-30	94	23650-57	99
21280-20	79	22505-11	84	23230-04	89	23536-40	94	23655-10	99
21280-25	79	22508-17	84	23230-05	89	23536-90	94	23655-20	99
21280-30	79	22510-12	85	23230-06	89	23538-18	94	23655-30	100
21290-09	79	22600-14	85	23240-10	89	23540-16	94	23655-40	100
21290-11	79	22600-50	85	23243-10	90	23545-15	94	23655-50	100
21290-13	79	22605-10	85	23243-20	90	23547-16	95	23660-17	100
21290-15	79	22605-50	85	23243-90	90	23550-14	95	23670-10	101
21300-09	80	22610-15	85	23244-02	90	23560-15	95	23680-21	101
21300-11	80	22610-50	85	23244-04	90	23565-25	95	23690-21	101
21300-13	80	22700-10	85	23244-06	90	23570-10	95	23700-25	101
21300-15	80	22700-20	85	23244-08	90	23570-13	95	23710-25	101
21310-02	80	22700-30	85	23244-10	90	23570-15	95	23720-10	101
21310-03	80	22700-90	85	23244-12	90	23580-10	95	23725-19	101
21310-04	80	22800-12	86	23244-90	90	23580-13	95	23725-25	102
21310-05	80	22810-12	86	23245-02	90	23580-15	95	23730-22	102
21310-06	80	22820-18	86	23245-04	90	23590-18	96	23732-10	102
21310-07	80	22830-18	86	23245-06	90	23590-22	96	23732-20	102
21310-08	80	22840-18	86	23245-08	90	23590-27	96	23735-18	103
21320-03	80	22860-20	86	23245-10	90	23590-28	96	23740-15	103
21320-04	80	22900-12	86	23245-12	90	23600-18	96	23750-19	103
21320-05	80	22910-12	86	23245-90	90	23600-22	96	23900-03	103
21400-14	80	22920-16	87	23250-03	90	23600-27	96	23900-04	103
21500-17	80	22930-16	87	23250-04	90	23600-28	96	24000-11	104
21510-17	80	23000-13	87	23250-05	90	23610-15	96	24010-11	104
21520-17	80	23010-13	87	23300-10	90	23611-05	96	24020-11	104
21530-18	81	23020-16	87	23310-10	90	23611-06	96	24030-10	104
21540-18	81	23030-16	87	23320-10	90	23612-25	97	24100-23	104
21600-15	81	23090-18	87	23330-10	90	23615-25	97	24105-18	105
21600-28	81	23091-18	87	23350-10	91	23615-32	97	24110-22	105
21700-10	81	23110-23	88	23360-10	91	23615-40	97	24120-22	105
21705-14	81	23120-23	88	23400-10	91	23616-25	97	24130-19	105
21705-18	81	23180-10	88	23410-10	91	23616-40	97	24200-10	105
21800-23	81	23180-12	88	23435-17	91	23617-25	97	24205-10	105
21810-10	81	23180-14	88	23440-19	91	23618-25	97	24205-12	105
21820-10	81	23180-16	88	23450-17	91	23623-25	97	24205-18	105
21830-10	82	23200-02	88	23455-17	91	23623-40	97	24210-20	106
21840-22	82	23200-03	88	23460-19	91	23631-25	98	24295-15	106
21850-18	82	23200-04	88	23490-02	92	23631-40	98	24295-25	106
21853-21	82	23200-05	88	23490-04	92	23632-25	98	24300-15	106
21855-16	82	23200-06	88	23490-06	92	23632-40	98	24300-25	106
21860-21	82	23200-07	88	23490-08	92	23634-25	97	24310-15	106
21863-17	82	23200-08	88	23490-10	92	23635-25	98	24310-25	106
21865-15	82	23200-09	88	23490-12	92	23635-40	98	24320-15	106
21866-21	83	23200-10	88	23490-14	92	23636-25	98	24320-25	106
21870-17	83	23200-11	88	23490-90	92	23636-40	98	24330-15	106
21880-17	83	23200-12	88	23500-12	92	23637-25	98	24330-25	106
21890-10	83	23200-13	88	23500-17	92	23637-40	98	24400-15	106
21900-10	83	23210-02	88	23505-25	92	23638-25	98	24400-50	106
21910-10	83	23210-04	88	23505-40	92	23638-40	98	24405-02	107



## Index - Numerical

24405-03	107	31370-70	117	31560-12	125	31710-90	129	31900-45	132
24405-04	107	31380-70	117	31560-13	125	31720-30	129	31900-48	132
24410-18	107	31390-70	117	31560-14	125	31720-40	129	31910-40	132
24420-18	107	31400-70	118	31570-01	125	31720-50	129	31960-70	133
24422-18	107	31410-70	118	31570-02	125	31720-60	129	32000-20	134
24425-03	107	31500-01	118	31570-03	125	31720-70	129	32000-25	134
24427-11	107	31500-02	118	31570-04	125	31720-85	129	32000-30	134
24430-50	107	31500-03	118	31570-05	125	31720-90	129	32000-35	134
24430-90	107	31500-04	118	31570-06	126	31730-33	130	32000-40	134
24440-50	107	31500-05	118	31570-07	126	31730-40	130	32000-45	134
24440-90	107	31500-06	119	31570-08	126	31730-50	130	32000-50	134
24445-50	107	31500-07	119	31580-01	126	31730-60	130	32000-55	134
24445-90	107	31500-08	119	31580-02	126	31730-70	130	32000-60	134
24450-50	107	31500-09	119	31580-03	126	31730-90	130	32010-20	134
24450-90	107	31500-10	119	31580-04	126	31740-10	130	32010-25	134
24460-10	107	31500-11	119	31580-05	126	31740-30	130	32010-30	134
24470-09	108	31505-12	119	31580-06	126	31740-50	130	32010-35	134
24470-10	108	31505-13	119	31580-07	127	31740-75	130	32010-40	134
24470-11	108	31505-14	119	31580-08	127	31740-90	130	32010-45	134
24480-19	108	31505-15	119	31580-09	127	31750-30	130	32010-50	134
24490-19	108	31505-16	120	31580-10	127	31750-50	130	32010-55	134
24500-24	108	31505-17	120	31580-11	127	31750-90	130	32010-60	134
24550-50	108	31510-01	120	31590-10	127	31760-00	130	32020-20	134
24550-60	108	31510-02	120	31600-16	127	31760-10	130	32020-25	134
24550-90	108	31510-03	120	31600-50	127	31760-20	130	32020-30	134
24600-13	108	31510-04	120	31650-50	128	31760-30	130	32020-35	134
24650-10	109	31510-05	120	31700-10	128	31760-40	130	32020-40	134
24670-16	109	31510-06	120	31700-20	128	31760-85	130	32020-45	134
24700-11	109	31510-07	120	31700-30	128	31760-90	130	32020-50	134
31000-04	110	31510-08	120	31700-40	128	31770-50	130	32020-55	134
31003-10	110	31510-09	121	31700-85	128	31770-60	130	32020-60	134
31005-10	110	31520-01	121	31700-90	128	31770-70	130	32030-20	134
31010-18	110	31525-01	121	31702-30	128	31770-90	130	32030-25	134
31020-18	110	31540-01	121	31702-40	128	31780-00	131	32030-30	134
31030-18	110	31540-02	121	31702-50	128	31780-05	131	32030-35	134
31040-18	111	31540-03	121	31702-70	128	31780-10	131	32030-40	134
31050-18	111	31540-04	121	31702-85	128	31780-20	131	32030-45	134
31060-18	111	31540-05	121	31702-90	128	31780-30	131	32030-50	134
31070-18	111	31540-06	121	31704-40	128	31780-40	131	32030-55	134
31080-18	111	31540-07	121	31704-50	128	31780-50	131	32030-60	134
31100-14	112	31540-08	122	31704-60	128	31780-60	131	32040-20	134
31110-15	112	31540-09	122	31704-70	128	31780-70	131	32040-25	134
31130-14	112	31540-10	122	31704-90	128	31780-90	131	32040-30	134
31140-13	112	31550-01	122	31708-10	129	31800-28	131	32040-35	134
31150-13	112	31550-02	122	31708-20	129	31800-55	131	32040-40	134
31160-13	112	31550-03	122	31708-30	129	31810-35	131	32040-45	134
31200-70	113	31550-04	122	31708-40	129	31810-40	131	32040-50	134
31210-70	113	31550-05	123	31708-50	129	31810-45	131	32040-55	134
31220-65	113	31550-06	123	31708-85	129	31810-50	131	32040-60	134
31230-70	113	31550-07	123	31708-90	129	31810-55	131	32100-06	134
31240-75	114	31550-08	123	31709-10	129	31810-60	131	32100-07	134
31250-75	114	31550-09	123	31709-20	129	31820-20	131	32100-08	134
31260-75	114	31560-01	123	31709-30	129	31820-25	131	32220-40	135
31270-75	114	31560-02	123	31709-40	129	31820-30	131	32290-07	135
31280-75	115	31560-03	124	31709-50	129	31820-35	131	32290-08	135
31290-70	115	31560-04	124	31709-85	129	31820-40	131	32290-09	135
31300-70	115	31560-05	124	31709-90	129	31820-45	131	32290-10	135
31310-70	115	31560-06	124	31710-30	129	31820-50	131	32290-11	135
31320-70	116	31560-07	124	31710-40	129	31820-55	131	32300-07	135
31330-75	116	31560-08	124	31710-50	129	31820-60	131	32300-08	135
31340-70	116	31560-09	124	31710-60	129	31830-35	132	32300-09	135
31350-70	116	31560-10	124	31710-70	129	31830-45	132	32300-10	135
31360-70	117	31560-11	124	31710-85	129	31840-35	132	32300-11	135

## Index - Numerical

32500-14	135	33210-06	138	34510-24	142	34800-19	146	35540-38	152
32510-17	135	33210-08	138	34510-26	142	34805-15	146	35540-50	152
32520-14	135	33220-19	138	34510-28	142	34810-17	146	35540-65	152
32530-10	135	33230-21	138	34510-30	142	34820-17	146	35540-75	152
32530-20	135	33240-20	138	34515-06	142	34830-17	146	35540-90	152
32530-30	135	33240-50	138	34515-08	142	34900-16	146	35545-38	152
32540-17	135	33260-26	138	34515-10	142	34910-17	147	35545-50	152
32600-08	136	33270-16	138	34515-12	142	34920-16	147	35545-65	152
32600-13	136	33280-16	139	34515-14	142	34930-16	147	35545-75	152
32700-05	136	33290-18	139	34515-16	142	35060-15	147	35545-90	152
32700-07	136	33295-19	139	34515-18	142	35070-24	147	35550-10	152
32700-09	136	33350-16	139	34515-20	142	35080-12	147	35550-20	152
32700-11	136	33360-21	139	34515-22	142	35090-12	147	35550-30	152
32800-10	136	33370-23	139	34515-24	142	35100-19	148	35550-40	152
32800-14	136	33400-20	139	34515-26	142	35110-19	148	35550-50	152
32800-16	136	33402-20	139	34515-28	142	35120-19	148	35550-60	152
32800-18	136	33410-22	139	34515-30	142	35130-19	148	35550-70	152
32810-08	136	33500-12	139	34520-06	142	35140-19	148	35550-80	152
32810-10	136	33510-01	140	34520-08	142	35150-19	148	35550-85	152
32810-12	136	33510-02	140	34520-10	142	35160-19	148	35550-90	152
32810-14	136	33510-03	140	34520-12	142	35165-19	148	35560-10	153
32810-16	136	33510-04	140	34520-14	142	35170-35	148	35560-20	153
32810-18	136	33510-05	140	34520-16	142	35170-40	148	35560-30	153
32820-20	136	33510-06	140	34520-18	142	35170-45	149	35560-40	153
32820-25	136	33510-07	140	34520-20	142	35170-50	149	35560-50	153
32820-30	136	33510-08	140	34520-22	142	35180-16	149	35560-60	153
32820-35	136	33510-09	140	34520-24	142	35200-06	149	35560-70	153
32820-40	136	33510-10	140	34520-26	142	35200-08	149	35560-80	153
32830-20	136	33510-11	140	34520-28	142	35205-06	149	35560-85	153
32830-25	136	33510-12	140	34520-30	142	35205-07	149	35560-90	153
32830-30	136	33510-13	140	34598-10	143	35205-08	149	35600-15	153
32830-35	136	33510-14	140	34598-20	143	35210-06	149	35700-28	153
32830-40	136	33520-03	140	34600-10	143	35210-08	149	35700-35	153
32840-20	137	33520-04	140	34600-20	143	35215-06	149	35700-40	153
32840-25	137	33520-05	140	34610-06	143	35215-07	149	35700-50	153
32840-30	137	33530-12	140	34610-07	143	35215-08	149	35700-55	153
32840-35	137	33700-17	140	34610-08	143	35300-10	149	35900-22	154
32840-40	137	33700-50	140	34610-10	143	35300-20	150	36000-16	154
32850-20	137	33700-90	140	34610-11	143	35300-30	150	36000-19	154
32850-25	137	33800-20	140	34620-10	144	35400-23	150	36090-15	154
32850-30	137	33900-30	141	34620-20	144	35400-50	150	36100-14	154
32850-35	137	33900-35	141	34620-30	144	35410-22	150	36200-14	154
32850-40	137	33900-40	141	34620-50	144	35410-50	150	36200-17	154
32857-10	137	33900-45	141	34620-90	144	35500-20	150	36210-13	155
32857-20	137	33900-55	141	34630-06	144	35500-32	150	36300-15	155
32857-30	137	33910-30	141	34630-07	144	35500-41	150	36310-15	155
32857-40	137	33920-30	141	34630-08	144	35500-60	150	36320-15	155
32859-20	137	33920-35	141	34630-10	144	35510-55	151	36330-15	155
32859-30	137	33920-40	141	34630-11	144	35510-65	151	36340-02	155
32860-15	137	33920-55	141	34640-10	144	35510-75	151	36340-04	155
32860-18	137	34000-14	141	34640-20	144	35510-90	151	36350-22	155
32870-15	137	34405-12	141	34650-10	145	35520-55	151	36360-22	155
32870-18	137	34420-12	141	34650-20	145	35520-65	151	36370-19	156
32880-06	138	34500-95	141	34650-30	145	35520-75	151	36380-04	156
32880-08	138	34510-06	142	34650-50	145	35520-90	151	36380-05	156
32880-09	138	34510-08	142	34650-60	145	35525-55	151	36390-04	156
32890-08	138	34510-10	142	34650-90	145	35525-65	151	36390-05	156
32890-10	138	34510-12	142	34660-10	145	35525-75	151	36400-16	156
32890-12	138	34510-14	142	34660-20	145	35525-90	151	36410-11	156
32890-14	138	34510-16	142	34660-30	145	35529-10	151	36420-11	156
32890-16	138	34510-18	142	34660-50	145	35529-20	151	36430-11	156
32890-18	138	34510-20	142	34660-90	145	35530-10	151	36440-45	157
33200-20	138	34510-22	142	34700-10	145	35530-20	151	36440-55	157

## Index - Numerical

36440-65	157	37220-10	163	38300-20	168	41860-10	172	42409-20	176
36440-80	157	37230-16	163	38300-30	168	41900-23	172	42410-25	176
36500-16	157	37230-18	163	38310-19	168	42000-16	173	42410-30	176
36510-18	157	37230-20	163	38320-06	168	42010-16	173	42410-35	176
36520-14	157	37240-06	163	38320-07	168	42020-16	173	42410-40	176
36530-14	157	37240-09	163	38320-09	168	42030-16	173	42410-45	176
36540-14	157	37240-12	163	38330-06	169	42040-12	173	42410-50	176
36550-14	157	37250-10	163	38330-07	169	42040-18	173	42410-55	176
36560-19	157	37250-20	163	38330-09	169	42100-24	173	42410-60	176
36570-16	158	37250-30	163	38400-17	169	42200-10	173	42413-40	176
36580-10	158	37260-10	164	38410-17	169	42200-20	173	42415-30	177
36580-20	158	37260-20	164	38420-15	169	42200-30	173	42415-40	177
36580-30	158	37260-30	164	41000-23	170	42200-40	173	42415-50	177
36580-40	158	37260-40	164	41010-23	170	42200-90	173	42415-60	177
36600-16	158	37260-50	164	41100-12	170	42300-25	173	42415-70	177
36700-15	158	37260-90	164	41200-11	170	42310-22	173	42415-80	177
36700-17	158	37270-10	164	41200-14	170	42350-40	174	42416-30	177
36800-70	159	37270-15	164	41200-17	170	42350-50	174	42416-40	177
36820-17	159	37270-20	164	41200-27	170	42350-60	174	42416-50	177
36830-70	159	37270-50	164	41200-38	170	42351-40	174	42416-60	177
36840-70	159	37280-28	164	41210-11	170	42351-50	174	42416-70	177
36850-70	160	37285-20	164	41210-14	170	42351-60	174	42416-80	177
36860-21	160	37285-24	164	41210-17	170	42390-30	174	42420-12	177
36870-20	160	37290-15	164	41210-27	170	42390-60	174	42420-20	177
36880-19	160	37290-20	164	41210-38	170	42390-80	174	42420-30	177
36900-02	161	37290-30	164	41250-24	170	42400-15	174	42420-40	177
36900-04	161	37300-16	165	41260-10	171	42400-20	174	42430-10	177
36900-06	161	37300-18	165	41260-14	171	42400-25	174	42430-20	177
36900-08	161	37300-20	165	41260-20	171	42400-30	174	42430-30	177
36900-10	161	37300-22	165	41270-20	171	42400-35	174	43440-10	177
36900-20	161	37300-24	165	41280-10	171	42400-40	174	43440-20	177
37000-15	161	37300-90	165	41280-14	171	42400-45	174	43440-30	177
37050-15	161	37310-18	165	41280-20	171	42400-50	174	43450-06	178
37200-03	161	37310-20	165	41290-08	171	42400-55	174	43450-09	178
37200-04	161	37310-22	165	41290-12	171	42400-60	174	43450-12	178
37200-05	161	37310-24	165	41290-16	171	42400-65	174	43460-12	178
37200-06	161	37310-26	165	41290-20	171	42400-70	174	43465-12	178
37200-07	161	37310-90	165	41300-08	171	42401-50	174	43470-12	178
37210-06	161	37320-17	165	41300-12	171	42401-60	174	43500-05	178
37214-15	162	37320-90	165	41300-16	171	42401-70	174	43500-10	178
37214-20	162	37410-92	165	41300-20	171	42401-80	174	43500-15	178
37214-25	162	37500-18	165	41310-08	171	42402-50	175	43500-20	178
37214-30	162	37505-15	165	41310-12	171	42402-60	175	43500-25	178
37214-40	162	37505-20	165	41310-16	171	42403-20	175	43500-30	178
37214-50	162	37510-12	166	41310-20	171	42403-25	175	43505-05	178
37215-15	162	37510-19	166	41320-08	171	42403-33	175	43505-10	178
37215-20	162	37510-22	166	41320-12	171	42403-40	175	43505-15	178
37215-25	162	37520-10	166	41320-16	171	42403-50	175	43505-20	178
37215-30	162	37600-16	166	41320-20	171	42403-55	175	43505-25	178
37215-40	162	37610-17	166	41800-24	172	42403-63	175	43505-30	178
37215-50	162	37700-20	167	41850-05	172	42403-80	175	43550-40	178
37216-15	162	37710-20	167	41850-10	172	42404-10	175	43550-45	178
37216-20	162	37900-27	167	41850-15	172	42404-20	175	43550-48	178
37216-25	162	37900-50	167	41850-20	172	42405-75	175	43550-55	178
37216-30	162	38000-12	167	41850-25	172	42405-83	175	43550-65	178
37216-40	162	38000-14	167	41850-30	172	42406-10	176	43580-24	179
37216-50	162	38100-17	167	41850-35	172	42406-20	176	43590-24	179
37217-15	162	38110-05	168	41850-40	172	42406-30	176	43595-15	179
37217-20	162	38110-06	168	41850-45	172	42406-40	176	43600-12	179
37217-25	162	38110-07	168	41850-50	172	42406-50	176	43600-20	179
37217-30	162	38110-08	168	41850-70	172	42408-32	176	43605-25	179
37217-40	162	38110-09	168	41850-90	172	42408-40	176	43610-20	179
37217-50	162	38300-10	168	41850-95	172	42408-48	176	43620-25	179

## Index - Numerical

43630-23	179	44030-20	186	44510-18	194	51230-20	198	52105-05	203
43640-25	180	44035-10	187	44510-19	194	51230-23	198	52105-07	203
43650-20	179	44035-20	187	44510-24	194	51240-17	198	52105-09	203
43660-22	179	44035-30	187	44520-15	194	51250-14	198	52105-11	203
43670-19	179	44035-35	187	44520-18	194	51260-14	199	52110-10	203
43680-19	180	44035-40	187	44520-19	194	51300-12	199	52110-15	203
43700-10	180	44035-50	187	44520-24	194	51300-17	199	52110-20	203
43700-20	180	44035-60	187	44530-15	194	51300-20	199	52110-25	203
43700-30	180	44035-70	187	44530-18	194	51300-22	199	52110-30	203
43700-40	180	44035-80	188	44530-19	194	51400-19	199	52111-02	203
43710-05	180	44035-90	187	44530-24	194	51410-15	199	52111-04	203
43710-07	180	44040-25	188	44540-15	195	51410-20	199	52111-06	203
43710-10	180	44050-10	188	44540-18	195	51420-20	199	52111-08	203
43710-90	180	44050-20	188	44540-19	195	51420-25	199	52111-10	203
43720-10	180	44050-30	188	44540-24	195	51420-30	199	52111-12	203
43725-10	180	44050-90	188	44600-22	195	51440-19	199	52180-40	204
43732-10	180	44055-90	189	44600-27	195	51440-20	199	52180-50	204
43732-20	181	44060-16	189	44600-33	195	51450-20	200	52200-10	204
43735-10	181	44070-20	190	50900-20	196	51460-19	200	52300-14	204
43740-10	181	44090-90	190	50900-25	196	51460-20	200	52310-14	204
43740-20	181	44150-19	190	50900-30	196	51470-17	200	52400-23	204
43740-30	181	44160-19	191	50900-40	196	51475-15	200	52450-20	205
43740-40	181	44170-19	191	50950-18	196	51500-10	200	52500-30	205
43740-50	181	44180-19	191	51000-20	196	51510-21	200	52550-04	205
43740-60	181	44330-19	191	51000-24	196	51512-21	200	52550-06	205
43740-90	181	44340-19	191	51000-28	196	51520-13	200	52550-08	205
43750-10	181	44350-19	192	51000-32	196	51600-30	201	52550-10	205
43750-20	181	44380-05	192	51000-36	196	51610-44	201	52550-12	205
43760-20	182	44380-07	192	51000-40	196	51610-57	201	52550-14	205
43800-27	182	44380-10	192	51110-37	196	51620-35	201	52600-30	205
43830-22	182	44380-12	192	51120-10	196	51630-26	201	52610-10	205
43850-23	182	44380-90	192	51120-20	196	51640-26	201	52610-15	205
43860-25	182	44400-16	192	51120-30	196	51645-32	201	52610-20	205
43900-16	183	44400-38	192	51122-10	196	51650-33	201	52610-25	205
43910-25	183	44400-60	192	51122-20	196	51651-33	201	52620-10	206
43917-20	183	44400-70	192	51122-30	196	51660-21	202	52620-15	206
43917-50	184	44400-80	192	51124-22	197	51739-19	220	52620-20	206
43920-18	184	44400-90	192	51124-24	197	51739-23	220	52620-25	206
43920-36	184	44410-09	193	51125-29	197	51739-27	220	52630-06	206
43920-44	184	44410-10	193	51126-10	197	51739-31	220	52630-08	206
43920-50	184	44410-12	193	51126-20	197	51739-35	220	52630-10	206
43920-65	184	44410-13	193	51126-30	197	51739-39	220	52630-12	206
43922-18	184	44410-15	193	51130-10	197	51740-19	220	52630-15	206
43922-50	184	44410-50	193	51130-20	197	51740-23	220	52630-20	206
43922-65	184	44410-60	193	51130-30	197	51740-27	220	52630-25	206
43970-09	184	44410-80	193	51140-10	197	51740-31	220	52630-30	206
43970-12	184	44410-90	193	51140-20	197	51740-35	220	52900-25	206
44000-10	185	44470-10	193	51140-30	197	51740-39	220	52900-38	206
44000-20	185	44470-20	193	51140-40	197	51780-16	202	52901-33	206
44000-30	185	44470-30	193	51140-50	197	51800-35	202	53160-17	206
44000-90	185	44485-10	193	51140-60	197	51800-45	202	53170-17	207
44005-27	185	44485-50	193	51200-25	198	51800-50	202	53180-17	207
44006-27	185	44485-60	193	51210-25	198	51900-17	202	53300-06	207
44010-10	186	44485-90	193	51220-15	198	51905-18	202	53310-18	207
44010-20	186	44487-10	194	51220-18	198	51910-18	203	53310-28	207
44010-30	186	44487-50	194	51220-20	198	52100-06	203	53310-32	207
44010-35	186	44487-90	194	51220-23	198	52100-10	203	53310-36	207
44010-40	186	44490-10	194	51225-15	198	52100-12	203	53311-18	207
44010-50	186	44500-15	194	51225-18	198	52100-15	203	53311-28	207
44010-90	186	44500-18	194	51225-20	198	52100-20	203	53311-32	207
44020-10	186	44500-19	194	51225-23	198	52100-25	203	53311-36	207
44020-15	186	44500-24	194	51230-15	198	52100-30	203	53315-14	207
44020-24	186	44510-15	194	51230-18	198	52100-90	203	53315-27	207

## Index - Numerical

53317-16	208	53820-10	211	54530-24	217	61160-21	224	61600-20	227
53317-32	208	53860-18	211	54531-24	217	61170-20	224	61600-21	227
53320-08	208	53870-18	211	54600-16	217	61170-24	224	61600-90	227
53325-18	208	53930-27	212	54610-15	217	61180-20	224	61610-02	227
53330-10	208	53940-30	212	54620-16	217	61180-24	224	61610-04	227
53340-18	208	54000-10	212	54630-16	218	61200-21	225	61610-06	227
53410-15	208	54000-20	212	54630-22	218	61200-23	225	61610-08	227
53500-10	209	54000-30	212	54800-22	218	61210-21	225	61610-10	227
53500-12	209	54000-40	212	54810-10	218	61210-23	225	61610-12	227
53500-15	209	54000-50	212	54810-16	218	61220-22	225	61610-14	227
53500-20	209	54000-55	212	54810-24	218	61220-24	225	61610-16	227
53500-25	209	54000-57	212	54820-10	218	61230-22	225	61610-18	227
53500-30	209	54000-60	212	54900-14	219	61230-24	225	61610-20	227
53500-90	209	54000-65	212	54900-18	219	61310-26	225	61610-22	227
53510-05	209	54000-67	212	55000-11	219	61320-25	225	61610-24	227
53510-06	209	54000-80	212	55100-15	219	61330-24	225	61610-26	227
53510-10	209	54000-90	212	55100-24	219	61340-08	225	61610-90	227
53510-12	209	54000-95	212	55110-20	219	61340-11	225	61610-95	227
53510-15	209	54005-10	212	55110-24	219	61340-14	225	61630-10	227
53510-20	209	54005-50	212	55130-52	219	61350-08	225	61700-26	228
53510-25	209	54005-90	212	55135-40	219	61350-11	225	61710-26	228
53510-30	209	54010-21	212	55135-50	219	61350-14	225	61850-13	228
53510-38	209	54020-08	213	55140-10	219	61360-22	226	61900-15	228
53510-90	209	54020-18	213	55150-38	220	61370-25	226	61910-17	228
53515-10	209	54020-43	213	55300-10	220	61380-06	226	62000-41	229
53515-13	209	54020-70	213	55300-50	220	61380-10	226	62020-41	229
53515-20	209	54030-22	213	55302-17	220	61380-13	226	62030-28	229
53515-25	209	54040-22	213	55305-14	221	61390-25	226	62040-28	229
53515-30	209	54050-10	213	55310-16	221	61400-06	226	62110-24	229
53518-02	210	54060-10	213	60920-20	222	61400-10	226	62400-25	230
53518-03	210	54060-20	213	61000-27	222	61400-13	226	62420-20	230
53518-04	210	54060-30	214	61010-10	222	61570-05	226	62500-11	230
53518-05	210	54060-40	214	61010-13	222	61570-06	226	62510-30	230
53518-06	210	54060-50	214	61010-16	222	61570-07	226	62600-20	230
53518-07	210	54060-90	214	61020-27	222	61570-08	226	62610-20	230
53518-08	210	54090-27	214	61030-14	222	61570-09	226	62620-23	231
53518-09	210	54100-17	214	61030-18	222	61570-10	226	62700-06	231
53518-10	210	54200-18	215	61035-14	222	61570-11	226	62700-09	231
53518-11	210	54210-04	215	61035-18	222	61570-12	226	62700-12	231
53518-12	210	54210-06	215	61035-50	222	61570-13	226	62710-10	231
53520-10	210	54210-08	215	61040-23	222	61570-14	226	62720-09	231
53520-15	210	54220-16	215	61060-16	223	61570-15	226	62730-09	231
53520-20	210	54220-19	215	61070-06	223	61570-16	226	62900-12	232
53520-25	210	54230-19	215	61070-07	223	61570-17	226	62910-14	232
53520-30	210	54240-15	215	61070-08	223	61570-18	226	62910-20	232
53530-10	210	54240-17	215	61070-09	223	61570-19	226	62915-22	232
53530-15	210	54250-17	215	61070-10	223	61570-20	226	62916-21	232
53530-20	210	54300-15	216	61070-12	223	61570-85	226	62920-10	232
53530-25	210	54310-16	216	61075-06	223	61570-90	226	62930-23	233
53530-30	210	54320-15	216	61075-07	223	61600-06	227	62940-23	233
53540-10	210	54330-16	216	61075-08	223	61600-07	227	62950-23	233
53540-13	210	54340-18	216	61075-09	223	61600-08	227	62960-24	233
53540-15	210	54350-10	216	61075-10	223	61600-09	227	63000-29	233
53540-20	210	54400-23	216	61075-12	223	61600-10	227	63010-30	233
53540-25	210	54450-10	217	61080-08	223	61600-11	227	63020-32	233
53540-30	210	54500-04	217	61080-09	223	61600-12	227	63200-17	234
53700-20	210	54500-05	217	61080-10	223	61600-13	227	63300-24	234
53710-22	211	54500-06	217	61100-20	223	61600-14	227	63414-50	234
53790-13	211	54501-04	217	61110-19	223	61600-15	227	63414-75	234
53800-10	211	54501-05	217	61120-20	224	61600-16	227	63450-60	234
53800-20	211	54501-06	217	61130-20	224	61600-17	227	63450-70	234
53800-30	211	54510-28	217	61140-20	224	61600-18	227	63450-80	234
53810-10	211	54511-28	217	61150-21	224	61600-19	227	63450-90	234

## Index - Numerical

63451-60	234	71501-40	240	72600-19	244	73520-03	250	81200-26	257
63451-70	234	71501-60	240	73100-06	244	73520-04	250	81200-28	257
63451-80	234	71501-70	240	73100-08	244	73520-05	250	81300-20	258
63451-90	234	71501-90	240	73100-09	244	73530-02	250	81310-14	258
63500-23	235	71600-19	240	73100-10	244	73530-03	250	81310-16	258
63510-23	235	71610-19	240	73100-11	244	73540-03	250	81320-14	258
63515-22	235	71630-16	240	73100-13	244	73540-04	250	81320-16	258
63520-18	235	71630-21	240	73100-16	244	73540-05	250	81400-10	258
63520-23	235	71640-17	240	73100-19	244	73550-03	250	81400-20	258
63530-23	235	71650-18	240	73100-22	244	73550-04	250	81400-30	258
71000-14	236	71660-16	240	73100-25	244	73550-05	250	81400-40	258
71010-14	236	71710-22	241	73110-10	244	73560-02	250	81400-90	258
71020-14	236	71720-17	241	73110-20	244	73560-03	250	81500-15	258
71030-14	236	71800-18	241	73110-30	244	73570-03	250	81500-20	258
71030-16	236	71810-21	241	73110-40	244	73570-04	250	81510-15	258
71030-18	236	71820-18	241	73110-85	244	73570-05	250	81510-20	258
71040-14	237	72000-19	241	73110-90	244	73580-03	250	81510-25	258
71040-16	237	72010-19	241	73110-95	244	73590-03	250	81520-15	258
71040-18	237	72020-12	241	73120-19	244	73600-03	250	81520-20	258
71050-14	237	72030-12	241	73120-22	244	73610-04	251	81520-25	258
71060-14	237	72040-25	241	73120-28	244	73620-10	251	81600-50	259
71070-14	237	72055-30	241	73160-10	244	73630-05	251	81600-90	259
71100-10	238	72100-05	242	73160-16	244	73630-06	251	81610-10	259
71110-21	238	72100-07	242	73160-25	244	73640-03	251	81610-60	259
71110-25	238	72110-05	242	73170-10	245	73650-04	252	81610-90	259
71200-09	238	72110-07	242	73180-10	245	73660-06	252	81645-09	259
71200-11	238	72119-13	242	73190-10	245	73670-10	252	81645-16	259
71200-13	238	72119-16	242	73195-18	245	73700-30	252	81645-20	259
71200-16	238	72119-20	242	73200-21	245	73710-50	252	81645-50	259
71200-19	238	72120-10	242	73280-14	245	73720-30	253	81645-90	259
71210-08	238	72120-13	242	73300-24	245	73720-50	253	81700-05	259
71210-10	238	72120-19	242	73310-24	245	73720-70	253	81700-10	259
71210-12	238	72124-18	242	73315-10	245	73800-17	253	81700-14	259
71210-15	238	72126-10	242	73315-20	245	73830-14	253	81700-20	259
71220-11	238	72130-04	242	73315-30	245	73831-14	253	81710-10	260
71220-13	238	72130-06	242	73330-30	246	73900-26	253	81720-07	260
71220-16	238	72130-08	242	73350-13	246	74000-07	254	81730-14	260
71220-19	238	72200-06	243	73360-14	246	74000-08	254	81730-21	260
71220-22	238	72200-08	243	73370-29	246	74000-09	254	81850-10	261
71230-12	238	72200-10	243	73400-03	247	74010-15	254	81850-50	261
71300-14	238	72200-11	243	73420-04	247	74020-05	254	81851-10	261
71300-16	238	72200-13	243	73420-05	247	74020-06	254	81900-18	261
71300-18	238	72200-16	243	73420-06	247	74020-07	254	81900-23	261
71310-06	239	72200-19	243	73430-04	247	74020-08	254	81910-17	261
71310-08	239	72200-25	243	73430-05	247	74020-09	254	81910-20	261
71310-10	239	72210-06	243	73430-06	247	74020-10	254	81910-24	261
71400-14	239	72210-13	243	73440-03	247	74020-11	254	81910-50	261
71400-17	239	72210-19	243	73440-04	247	74020-12	254	81960-10	262
71430-16	239	72210-25	243	73450-03	248	74300-90	254	82000-13	262
71500-20	239	72210-32	243	73450-04	248	74400-90	255	82000-50	262
71500-25	239	72220-06	243	73450-05	248	74410-90	255	82000-70	262
71500-27	239	72220-08	243	73460-04	248	75000-10	255	82000-75	262
71500-30	239	72220-10	243	73460-05	248	75010-38	256	82010-10	263
71500-32	239	72220-11	243	73460-07	248	75010-44	256	82010-15	263
71500-40	239	72220-13	243	73470-03	248	75010-51	256	82010-20	263
71500-60	239	72220-15	243	73470-05	248	81000-35	257	82010-22	263
71500-70	239	72220-16	243	73480-03	249	81010-43	257	82010-30	263
71500-90	239	72220-19	243	73480-05	249	81015-35	257	82010-32	263
71501-20	240	72220-20	243	73490-04	249	81015-40	257	82010-40	263
71501-25	240	72220-25	243	73500-08	249	81020-25	257	82010-42	263
71501-27	240	72220-30	243	73510-03	250	81020-35	257	82010-50	263
71501-30	240	72300-12	243	73510-04	250	81020-43	257	82010-52	263
71501-32	240	72600-14	244	73510-05	250	81100-23	257	82010-80	263



## Index - Numerical

82010-90	263	91010-32	267	91050-12	272	92180-12	275	97800-30	281
82110-30	263	91010-90	267	91050-13	272	92180-18	275	97800-40	281
82120-30	263	91020-07	267	91050-14	272	92180-25	275	97800-50	281
82130-26	263	91020-09	267	91050-15	272	92200-09	275	97800-60	281
82140-26	264	91020-11	267	91050-16	272	92200-11	275	97800-90	281
82200-05	264	91020-90	267	91050-17	272	92200-13	275	99050-10	285
82200-10	264	91025-10	268	91050-18	272	92200-15	275	99050-20	285
82200-15	264	91025-12	268	91050-19	272	92200-18	275	99050-30	285
82200-20	264	91025-14	268	91050-20	272	92210-24	275	99051-10	285
82200-25	264	91025-16	268	91050-21	272	92220-24	275	99051-20	285
82200-30	264	91025-18	268	91050-22	272	92225-24	276	99055-10	285
82200-35	264	91025-20	268	91050-23	272	92230-10	276	99055-20	285
82200-40	264	91025-22	268	91050-24	272	92230-20	276	99055-30	285
82200-45	264	91025-24	268	91050-25	272	92230-90	276	99055-40	285
82200-55	264	91025-26	268	91050-26	272	92300-90	276	99055-50	285
82200-60	264	91025-28	268	91050-27	272	92310-90	277	99100-10	285
82200-65	264	91025-30	268	91050-28	272	92350-10	277	99100-20	285
82210-85	264	91030-01	269	91050-29	272	92360-10	277	99100-30	285
82210-90	264	91030-02	269	91050-30	272	92400-10	277	99150-10	286
82220-50	264	91030-03	269	91050-31	272	92400-20	277	99150-20	286
82220-85	264	91030-04	269	91050-32	272	92400-30	278	99150-30	286
82220-90	264	91030-05	269	91050-33	272	92400-40	278	99151-10	286
82230-50	264	91030-06	269	91050-34	272	92450-10	278	99151-20	286
82230-85	264	91030-07	269	91050-35	272	95000-10	279	99160-10	286
82230-90	264	91030-08	269	91050-36	272	95010-10	279	99160-20	286
82300-38	265	91030-09	269	91050-37	272	96180-10	279	99161-10	286
91000-06	266	91030-10	269	91050-38	272	96180-20	279	99161-20	286
91000-07	266	91030-11	269	91050-39	272	96180-30	279	99170-10	286
91000-08	266	91030-12	269	91050-90	272	96180-40	279	99170-20	286
91000-09	266	91030-13	269	91100-45	272	96180-50	279	99170-30	286
91000-10	266	91030-14	269	91110-45	272	96180-60	279	99171-10	286
91000-11	266	91030-15	269	91112-02	272	96180-70	279	99171-20	286
91000-12	266	91030-16	269	91120-02	272	96180-80	279	99180-10	286
91000-13	266	91030-17	269	91120-04	272	96180-85	279	99180-20	286
91000-14	266	91030-18	269	91130-02	272	96180-90	279	99181-10	286
91000-15	266	91030-19	269	91135-02	273	96180-95	279	99181-20	286
91000-16	266	91030-20	269	91138-03	273	96200-04	279	99185-10	286
91000-17	266	91030-21	269	91140-12	273	96200-06	279	99185-20	286
91000-18	266	91030-90	269	91140-16	273	96200-10	279	99185-30	286
91000-19	266	91038-08	270	91140-24	273	96200-30	279	99185-40	286
91000-20	266	91046-04	271	91145-12	273	96200-50	279	99185-50	286
91000-21	266	91046-05	271	91200-10	273	96200-70	279	99185-60	286
91000-22	266	91046-06	271	91200-20	273	96200-85	279	99185-70	286
91000-23	266	91046-07	271	91200-30	273	96200-90	279	99185-80	286
91000-24	266	91046-08	271	91300-20	273	96200-95	279	99200-10	287
91006-01	266	91046-09	271	91310-11	273	96430-09	280	99200-20	287
91006-05	266	91046-10	271	91400-26	274	96430-11	280	99200-30	287
91006-09	266	91046-11	271	91500-04	274	96440-09	280	99220-10	287
91006-13	266	91046-12	271	91500-10	274	96440-11	280	99220-20	287
91006-17	266	91046-13	271	91500-16	274	96450-09	280	99220-30	287
91006-21	266	91046-14	271	91500-22	274	96450-11	280	99250-10	287
91006-26	266	91046-15	271	91500-28	274	96460-09	280	99250-20	287
91010-10	267	91046-16	271	91500-90	274	96460-11	280	99250-30	287
91010-12	267	91046-17	271	91600-23	274	96630-09	280	99250-40	287
91010-14	267	91046-18	271	91750-20	274	96630-11	280	99300-10	288
91010-16	267	91046-19	271	91800-10	275	96640-09	280	99300-20	288
91010-18	267	91046-20	271	91800-20	275	96640-11	280	99300-30	288
91010-20	267	91046-21	271	91800-30	275	96860-10	280	99305-10	288
91010-22	267	91046-22	271	91800-90	275	96885-08	280	99305-20	288
91010-24	267	91046-23	271	91900-03	275	96900-10	281	99305-30	288
91010-26	267	91046-24	271	91900-07	275	97100-11	281	99305-40	288
91010-28	267	91050-10	272	91900-09	275	97110-10	281	99305-50	288
91010-30	267	91050-11	272	91900-90	275	97120-10	281	99305-60	288

## Index - Numerical

99350-10	283
99351-10	283
99352-10	283
99353-10	283
99355-10	283
99365-10	284
99380-10	284
99420-10	282
99430-10	282
99440-10	282
99450-10	282
99460-10	282
99500-10	288
99500-20	288
99500-30	288
99600-10	288
99600-20	288
99600-30	288
99650-10	289
99650-20	289
99650-30	289
99700-10	282
99710-10	282
99730-10	282
99750-10	283
99760-10	283
99800-10	289
99800-20	289
99800-30	289





SDI GROUP  
Scansorial Dove International  
Raheem Pura Shahab Pura Sialkot 51340-PAKISTAN  
Tel: +92-52-3256157, Fax: +92-52-3557751, Email [info@scandoveint.com](mailto:info@scandoveint.com)  
[www.scandoveint.com](http://www.scandoveint.com)  
ISO 9001:2003, ISO 13485:2003, CE, cGMP, FDA